





(b)

 <p>CABLE STRAIN RELIEF (1x)</p>	 <p>LENS HEAD SCREW (4x)</p>
 <p>SHORT SCREW (2x)</p>	 <p>PRESS INSERT (1x)</p>

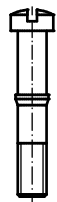

(b)

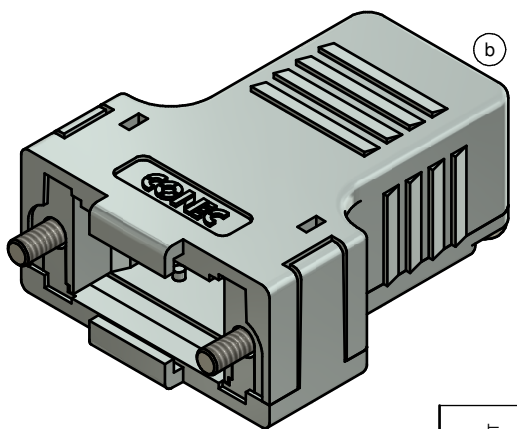
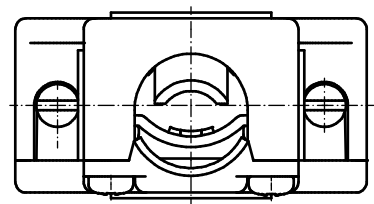
NOTES:

1. METALHOOD+COVER: ABS UL 94 V-0; METALLIZED
2. CABLE STRAIN RELIEF: STEEL; NICKEL PLATED
3. PRESS INSERT: ABS UL 94 V-0; METALLIZED
4. SHORT SCREWS: STEEL; NICKEL PLATED
5. LENS HEAD SCREWS: STEEL; NICKEL PLATED

TECHNICAL DATA:

- TEMPERATURE RANGE: -33 °C to + 90 °C

Directive 2011/65/EU RoHS compliant

THIS DRAWING MAY NOT BE COPIED OR REPRODUCED IN ANY WAY, AND MAY NOT BE PASSED ON TO A THIRD PARTY WITHOUT WRITTEN PERMISSION. OWNERSHIP AND COPYRIGHT OF CONEC GmbH DO NOT ALTER CAD DRAWING BY HAND	tolerance		 scale: 2:1 material: SEE NOTES	
	date	name	title: PLASTIC HOOD 9pos. with straight cable exit	
	drawn	03.09.14 Unkrüer		
	appd.	04.09.14 Lehmenkühler		
	norm		title: PLASTIC HOOD 9pos. with straight cable exit	
	d-old	16K2A171A	dwg no: (b) 16K1A3513	
	3 x b	Ä 5304	03.09.2014	Unkrüer
a	Original			sh: 1
rev.	description	date	name	part no: 165X13469X

