

B2 BASICS WITH INTEGRAL LEVERS

SINGLE BREAK, SNAP-ACTION, COMMERCIAL & MILITARY GRADES, SUBMINIATURE, TWO WIDTHS, INTEGRAL LEVERS

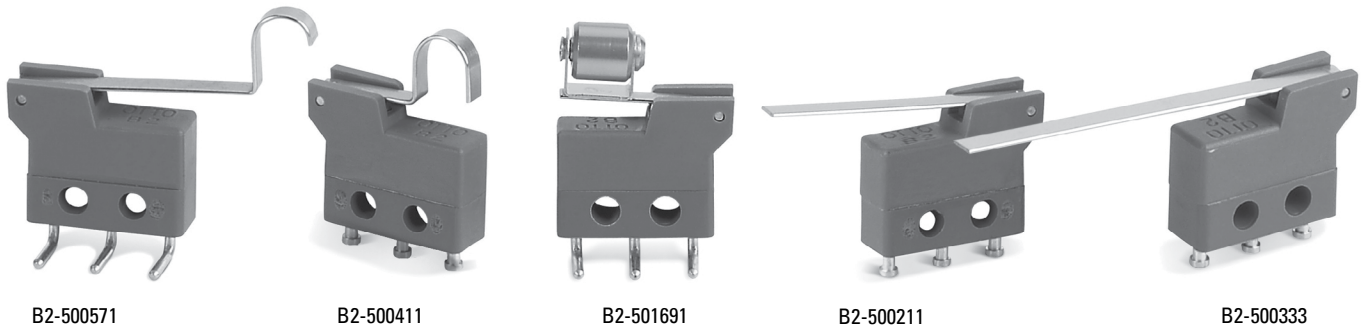

Shown are examples of available lever styles.

B2-5 Integral Lever Basic Switches

B2-5 series basic switches feature integral actuating levers. The lever is built-in so that the switch and actuator are one assembly.

Making the lever actuator an integral part of the basic switch case makes sense and saves money, too. Better precision, no auxiliary parts for you to assemble, and more variety add up to a cost saving proposition.

Lever Style	Catalog Number	STANDARD OPERATIONAL CHARACTERISTICS					
		Operating Force (max ounces)	Release Force (min ounces)	Pretravel (max inches)	Overtravel (min inches)	Move't Differ'l (max inches)	Operating Point (inches)
Short Lever	B2-500111	1.76	0.32	0.065	0.014	0.020	0.330 +/- 0.045
Medium Lever	B2-500211	1.10	0.18	0.115	0.025	0.035	0.330 +/- 0.045
Long Lever	B2-500311	0.71	0.11	0.185	0.046	0.060	0.330 +/- 0.045
Short Formed "U" Lever	B2-500411	2.10	0.39	0.050	0.010	0.015	0.553 +/- 0.035
Long Formed "U" Lever	B2-500511	1.10	0.18	0.105	0.022	0.035	0.572 +/- 0.070
Lever Style with Hole	B2-500611	1.10	0.18	0.115	0.025	0.035	0.330 +/- 0.045
Short "V" Lever	B2-501211	3.00	0.57	0.042	0.010	0.010	0.419 +/- 0.030
Roller Sleeve Sideways	B2-501611	2.29	0.43	0.065	0.008	0.020	0.560 +/- 0.045
Short "L" Lever	B2-501711	3.00	0.57	0.036	0.008	0.009	0.411 +/- 0.028
Short Flat "V" Lever	B2-501811	2.20	0.40	0.049	0.010	0.015	0.421 +/- 0.037
Roller Lever in Line	B2-501911	2.29	0.43	0.070	0.008	0.020	0.559 +/- 0.050
Long Roller Lever in Line	B2-502011	1.00	0.17	0.125	0.020	0.040	0.552 +/- 0.100

B2-5 PART NUMBER CODE

B2-5 **X X X**

Lever Style

- 001. Short Straight
- 002. Medium Straight
- 003. Long Straight
- 004. Short Formed "U"
- 005. Long Formed "U"
- 006. With Hole
- 012. Short "V"
- 016. Roller Sleeve Sideways
- 017. Short "L"
- 018. Short Flat "V"
- 019. Roller Lever in Line
- 020. Long Roller Lever in Line

X

Terminal Style or Wire Length

- 1. Single Solder Turret
- 2. Double Solder Turret
- 3. Quick Connect*
- 4. PC Pin 0.150" lg.
- 5. PC Pin 0.270" lg.
- 6. PC Pin 0.090" lg.
- 7. Right Angle PC Pin
- 9. Right Angle**
- A. With Wires 06.0" lg.
- B. With Wires 12.0" lg.
- C. With Wires 18.0" lg.
- D. With Wires 24.0" lg.
- E. With Wires 30.0" lg.

X

Contact Material

- 1. Silver/Gold - High Current
- 3. Silver/Gold - Low Current

* Mates with AMP .058" receptacles

** Opposite of 7

B2 BASICS WITH INTEGRAL LEVERS

B2-5
BASIC SWITCHES

SINGLE BREAK, SNAP-ACTION, COMMERCIAL & MILITARY GRADES, SUBMINIATURE, TWO WIDTHS, INTEGRAL LEVERS



WIRE LENGTH FOR A, B, C, D & E

WIRE LENGTH CODE	DIM. "X"	DIM. "Y"
A	06.00±.38	06.09±.38
B	12.00±.50	12.09±.50
C	18.00±.50	18.09±.50
D	24.00±.50	24.09±.50
E	30.00±.75	30.09±.75

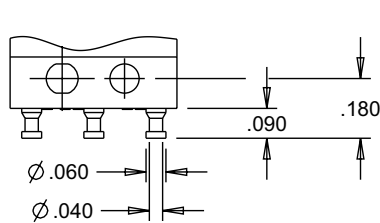

TERMINAL STYLE 1
SINGLE SOLDER TURRET

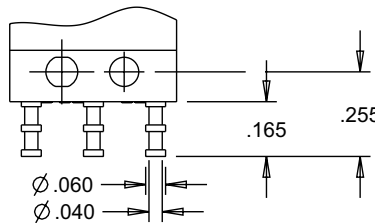

TERMINAL STYLE 2
DOUBLE SOLDER TURRET

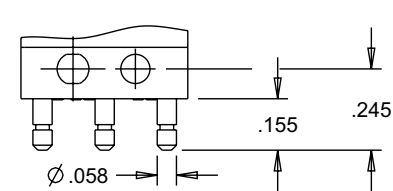

TERMINAL STYLE 3
QUICK CONNECT
MATES WITH AMP .058 INCH RECEPTACLES

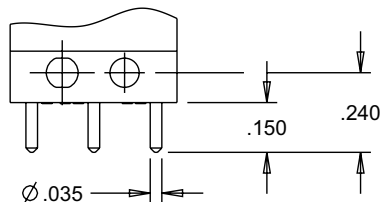

TERMINAL STYLE 4
PRINTED CIRCUIT PIN 0.150" LONG

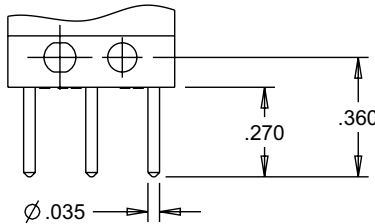

TERMINAL STYLE 5
PRINTED CIRCUIT PIN 0.270" LONG

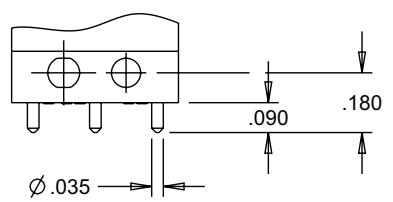

TERMINAL STYLE 6
PRINTED CIRCUIT PIN 0.090" LONG

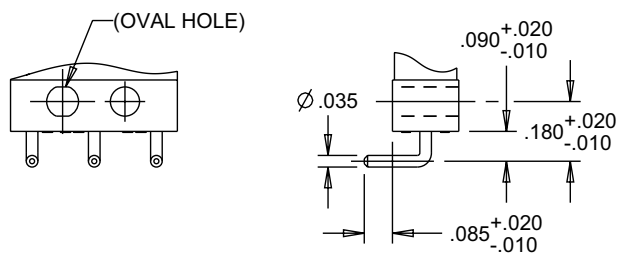

TERMINAL STYLE 7
RIGHT ANGLE PRINTED CIRCUIT PIN

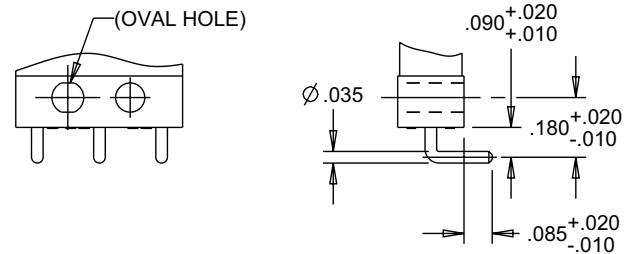

TERMINAL STYLE 9
RIGHT ANGLE, OPPOSITE OF 7

BASIC SWITCHES

SINGLE BREAK, SNAP-ACTION, COMMERCIAL & MILITARY GRADES, SUBMINIATURE, TWO WIDTHS, INTEGRAL LEVERS

B2-5 LEVER STYLES



B2 BASICS WITH INTEGRAL LEVERS

B2-5
BASIC SWITCHES

SINGLE BREAK, SNAP-ACTION, COMMERCIAL & MILITARY GRADES, SUBMINIATURE, TWO WIDTHS, INTEGRAL LEVERS

B2-5 LEVER STYLES



BASIC SWITCHES