

### FEATURES

- Excellent Noise Performance:**  $1.0 \text{ nV}/\sqrt{\text{Hz}}$  or **1.5 dB Noise Figure**
- Ultra-low THD:**  $< 0.01\%$  @  $G = 100$  Over the **Full Audio Band**
- Wide Bandwidth:**  $1 \text{ MHz}$  @  $G = 100$
- High Slew Rate:**  $16 \text{ V}/\mu\text{s}$  @  $G = 10$
- 10 V rms Full-Scale Input,**  
 $G = 1, V_S = \pm 18 \text{ V}$
- Unity Gain Stable**
- True Differential Inputs**
- Subaudio 1/f Noise Corner**
- 8-Lead PDIP or 16-Lead SOIC**
- Only One External Component Required**
- Very Low Cost**
- Extended Temperature Range:**  $-40^\circ\text{C}$  to  $+85^\circ\text{C}$

### APPLICATIONS

- Audio Mix Consoles
- Intercom/Paging Systems
- 2-Way Radio
- Sonar
- Digital Audio Systems

### GENERAL DESCRIPTION

The SSM2019 is a latest generation audio preamplifier, combining SSM preamplifier design expertise with advanced processing. The result is excellent audio performance from a monolithic device, requiring only one external gain set resistor or potentiometer. The SSM2019 is further enhanced by its unity gain stability.

Key specifications include ultra-low noise (1.5 dB noise figure) and THD ( $< 0.01\%$  at  $G = 100$ ), complemented by wide bandwidth and high slew rate.

Applications for this low cost device include microphone preamplifiers and bus summing amplifiers in professional and consumer audio equipment, sonar, and other applications requiring a low noise instrumentation amplifier with high gain capability.

### FUNCTIONAL BLOCK DIAGRAM

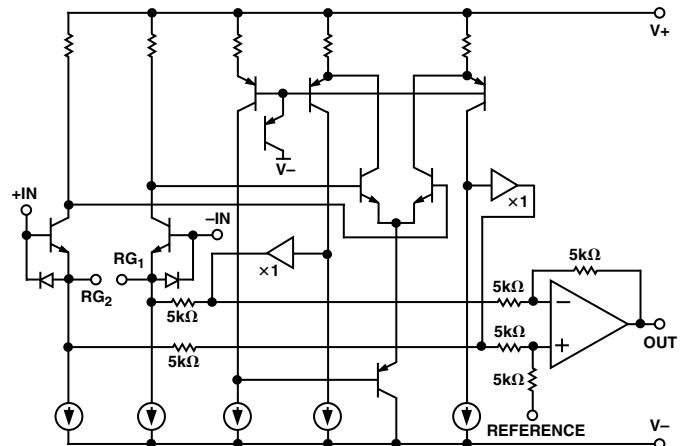

### PIN CONNECTIONS

8-Lead PDIP (N Suffix)

8-Lead Narrow Body SOIC (RN Suffix)\*

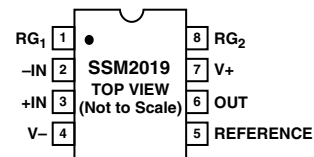

16-Lead Wide Body SOIC (RW Suffix)

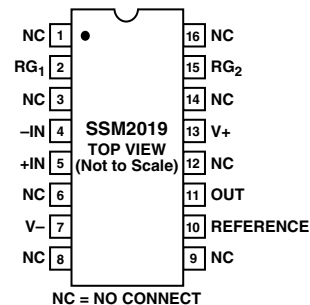

\*Consult factory for availability.

REV. A

Information furnished by Analog Devices is believed to be accurate and reliable. However, no responsibility is assumed by Analog Devices for its use, nor for any infringements of patents or other rights of third parties that may result from its use. No license is granted by implication or otherwise under any patent or patent rights of Analog Devices. Trademarks and registered trademarks are the property of their respective companies.

# SSM2019—SPECIFICATIONS ( $V_S = \pm 15\text{ V}$ and $-40^\circ\text{C} \leq T_A \leq +85^\circ\text{C}$ , unless otherwise noted. Typical specifications apply at $T_A = 25^\circ\text{C}$ .)

Parameter	Symbol	Conditions	Min	Typ	Max	Unit
<b>DISTORTION PERFORMANCE</b>						
Total Harmonic Distortion Plus Noise	THD + N	$V_O = 7\text{ V rms}$ $R_L = 2\text{ k}\Omega$ $f = 1\text{ kHz}, G = 1000$ $f = 1\text{ kHz}, G = 100$ $f = 1\text{ kHz}, G = 10$ $f = 1\text{ kHz}, G = 1$ $BW = 80\text{ kHz}$		0.017 0.0085 0.0035 0.005		% % % %
<b>NOISE PERFORMANCE</b>						
Input Referred Voltage Noise Density	$e_n$	$f = 1\text{ kHz}, G = 1000$ $f = 1\text{ kHz}, G = 100$ $f = 1\text{ kHz}, G = 10$ $f = 1\text{ kHz}, G = 1$		1.0 1.7 7 50		$\text{nV}/\sqrt{\text{Hz}}$ $\text{nV}/\sqrt{\text{Hz}}$ $\text{nV}/\sqrt{\text{Hz}}$ $\text{nV}/\sqrt{\text{Hz}}$
Input Current Noise Density	$i_n$	$f = 1\text{ kHz}, G = 1000$		2		$\text{pA}/\sqrt{\text{Hz}}$
<b>DYNAMIC RESPONSE</b>						
Slew Rate	SR	$G = 10$ $R_L = 2\text{ k}\Omega$		16		$\text{V}/\mu\text{s}$
Small Signal Bandwidth	$BW_{-3\text{ dB}}$	$C_L = 100\text{ pF}$ $G = 1000$ $G = 100$ $G = 10$ $G = 1$		200 1000 1600 2000		$\text{kHz}$ $\text{kHz}$ $\text{kHz}$ $\text{kHz}$
<b>INPUT</b>						
Input Offset Voltage	$V_{IOS}$			0.05	0.25	mV
Input Bias Current	$I_B$	$V_{CM} = 0\text{ V}$		3	10	$\mu\text{A}$
Input Offset Current	$I_{OS}$	$V_{CM} = 0\text{ V}$		$\pm 0.001$	$\pm 1.0$	$\mu\text{A}$
Common-Mode Rejection	CMR	$V_{CM} = \pm 12\text{ V}$ $G = 1000$ $G = 100$ $G = 10$ $G = 1$	110 90 70 50	130 113 94 74		dB dB dB dB
Power Supply Rejection	PSR	$V_S = \pm 5\text{ V to } \pm 18\text{ V}$ $G = 1000$ $G = 100$ $G = 10$ $G = 1$	110 110 90 70	124 118 101 82		dB dB dB dB
Input Voltage Range	IVR		$\pm 12$			V
Input Resistance	$R_{IN}$	Differential, $G = 1000$ $G = 1$ Common Mode, $G = 1000$ $G = 1$		1 30 5.3 7.1		$\text{M}\Omega$ $\text{M}\Omega$ $\text{M}\Omega$ $\text{M}\Omega$
<b>OUTPUT</b>						
Output Voltage Swing	$V_O$	$R_L = 2\text{ k}\Omega, T_A = 25^\circ\text{C}$	$\pm 13.5$	$\pm 13.9$		V
Output Offset Voltage	$V_{OOS}$			4	30	mV
Maximum Capacitive Load Drive				5000		pF
Short Circuit Current Limit	$I_{SC}$	Output-to-Ground Short		$\pm 50$		mA
Output Short Circuit Duration				Continuous		sec
<b>GAIN</b>						
Gain Accuracy	$R_G = \frac{10\text{ k}\Omega}{G-1}$	$T_A = 25^\circ\text{C}$ $R_G = 10\ \Omega, G = 1000$ $R_G = 101\ \Omega, G = 100$ $R_G = 1.1\text{ k}\Omega, G = 10$ $R_G = \infty, G = 1$	0.5 0.5 0.5 0.1	0.1 0.2 0.2 0.2		dB dB dB dB
Maximum Gain	G			70		dB
<b>REFERENCE INPUT</b>						
Input Resistance				10		$\text{k}\Omega$
Voltage Range				$\pm 12$		V
Gain to Output				1		V/V
<b>POWER SUPPLY</b>						
Supply Voltage Range	$V_S$		$\pm 5$		$\pm 18$	V
Supply Current	$I_{SY}$	$V_{CM} = 0\text{ V}, R_L = \infty$ $V_{CM} = 0\text{ V}, V_S = \pm 18\text{ V}, R_L = \infty$		$\pm 4.6$ $\pm 4.7$	$\pm 7.5$ $\pm 8.5$	mA mA

Specifications subject to change without notice.

**ABSOLUTE MAXIMUM RATINGS<sup>1</sup>**

Supply Voltage	.....	±19 V
Input Voltage	.....	Supply Voltage
Output Short Circuit Duration	.....	10 sec
Storage Temperature Range	.....	-65°C to +150°C
Junction Temperature (T <sub>J</sub> )	.....	-65°C to +150°C
Lead Temperature Range (Soldering, 60 sec)	.....	300°C
Operating Temperature Range	.....	-40°C to +85°C
Thermal Resistance <sup>2</sup>		
8-Lead PDIP (N)	.....	$\theta_{JA} = 96^{\circ}\text{C/W}$
	.....	$\theta_{JC} = 37^{\circ}\text{C/W}$
16-Lead SOIC (RW)	.....	$\theta_{JA} = 92^{\circ}\text{C/W}$
	.....	$\theta_{JC} = 27^{\circ}\text{C/W}$

**NOTES**

<sup>1</sup> Stresses above those listed under Absolute Maximum Ratings may cause permanent damage to the device. This is a stress rating only; functional operation of the device at these or any other conditions above those indicated in the operational section of this specification is not implied. Exposure to absolute maximum rating conditions for extended periods may affect device reliability.

<sup>2</sup>  $\theta_{JA}$  is specified for worst-case mounting conditions, i.e.,  $\theta_{JA}$  is specified for device in socket for PDIP;  $\theta_{JA}$  is specified for device soldered to printed circuit board for SOIC package.

**CAUTION**

ESD (electrostatic discharge) sensitive device. Electrostatic charges as high as 4000 V readily accumulate on the human body and test equipment and can discharge without detection. Although the SSM2019 features proprietary ESD protection circuitry, permanent damage may occur on devices subjected to high energy electrostatic discharges. Therefore, proper ESD precautions are recommended to avoid performance degradation or loss of functionality.



**Typical Performance Characteristics**

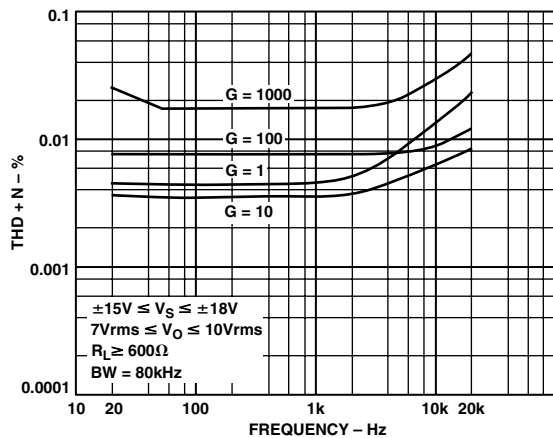

TPC 1. Typical THD + Noise vs. Gain

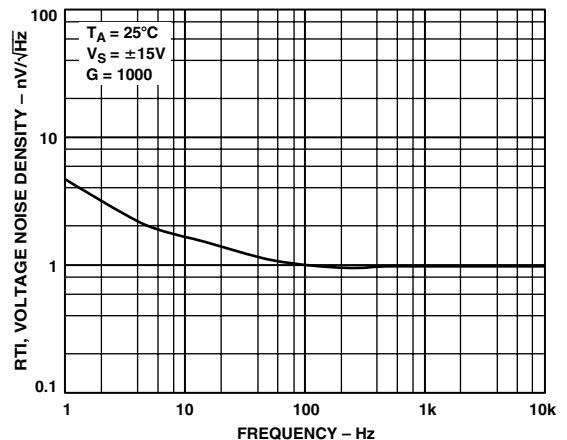

TPC 2. Voltage Noise Density vs. Frequency

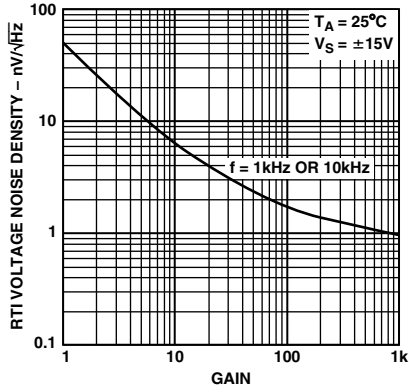

TPC 3. RTI Voltage Noise Density vs. Gain

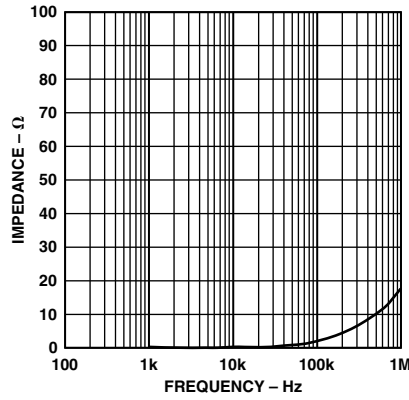

TPC 4. Output Impedance vs. Frequency

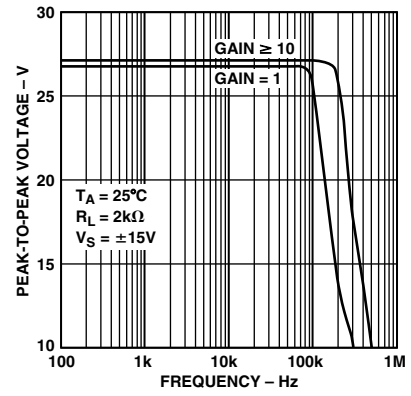

TPC 5. Maximum Output Swing vs. Frequency

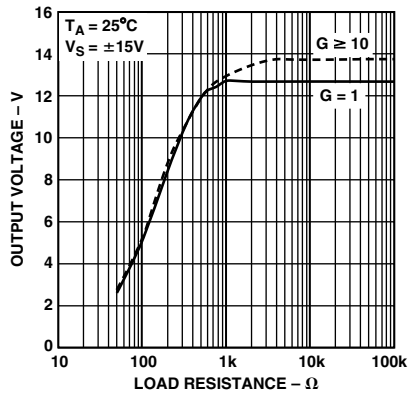

TPC 6. Output Voltage vs. Load Resistance

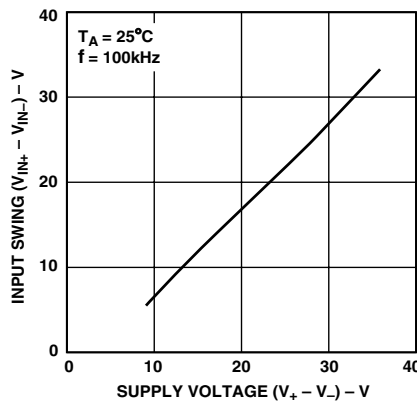

TPC 7. Input Voltage Range vs. Supply Voltage

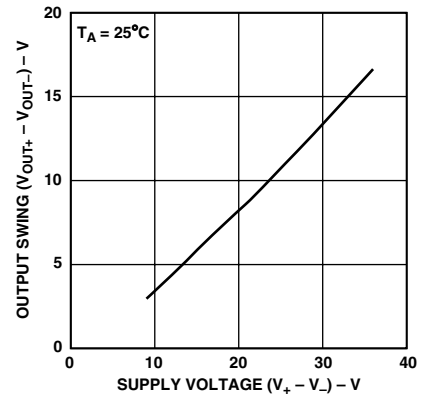

TPC 8. Output Voltage Range vs. Supply Voltage

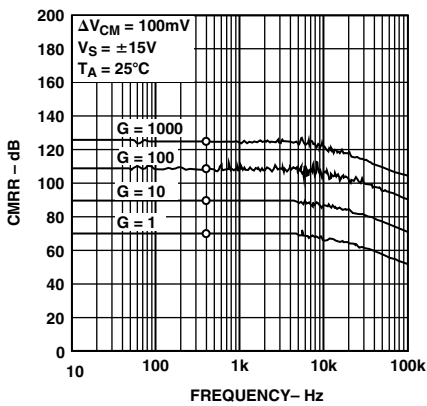

TPC 9. CMRR vs. Frequency

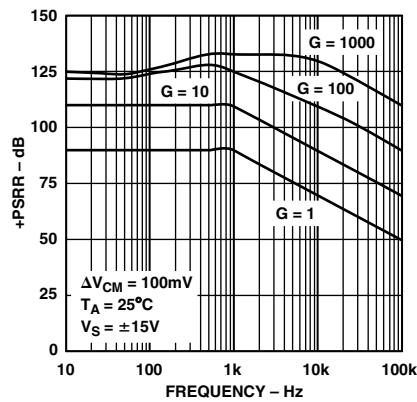

TPC 10. Positive PSRR vs. Frequency

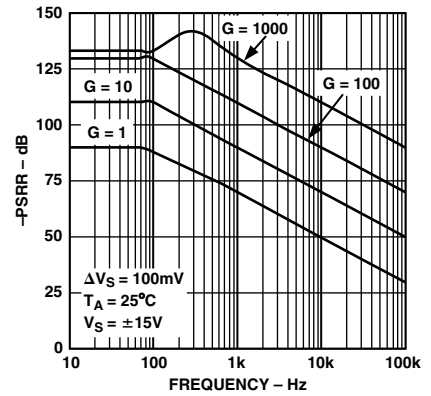

TPC 11. Negative PSRR vs. Frequency

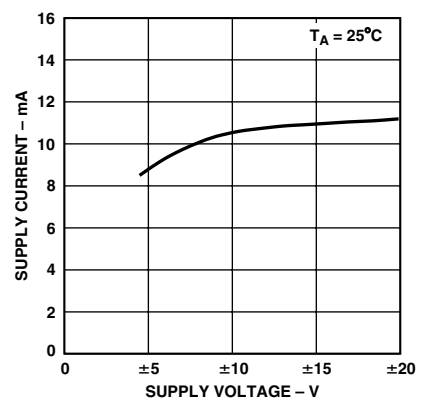
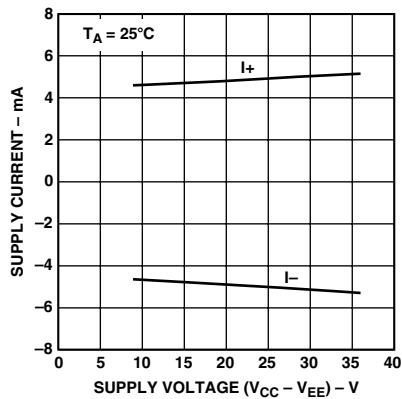
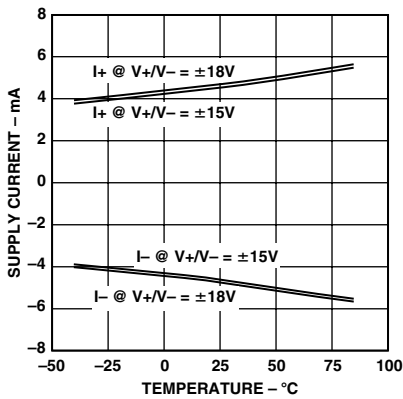
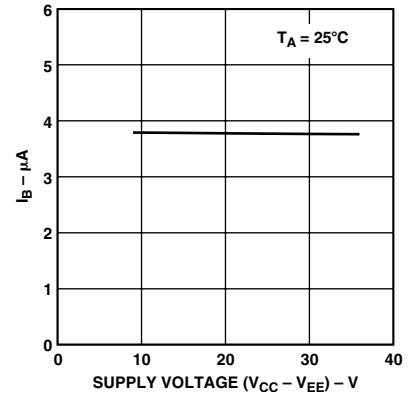
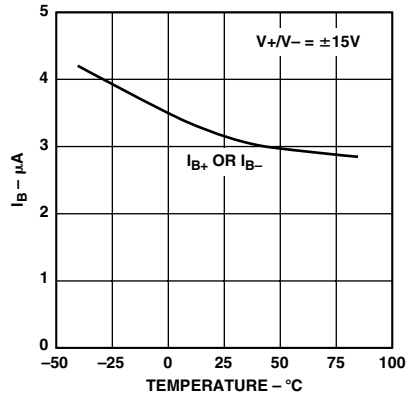
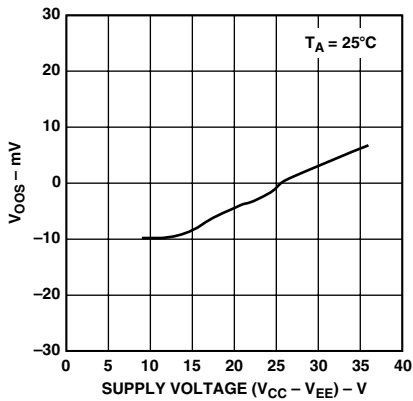
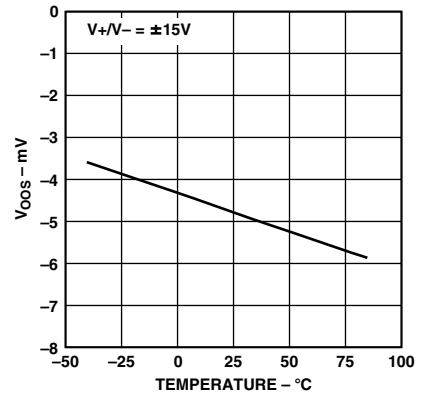
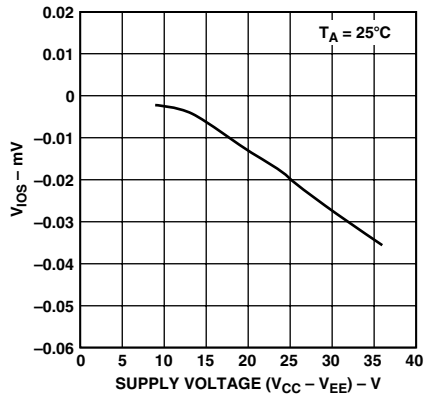
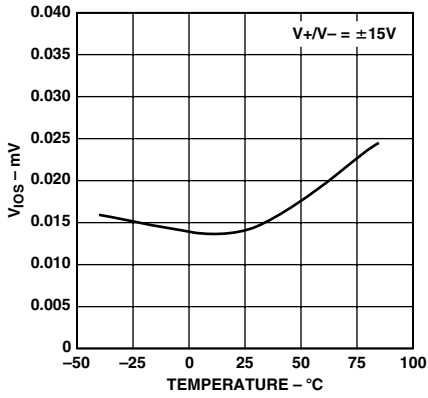

# SSM2019

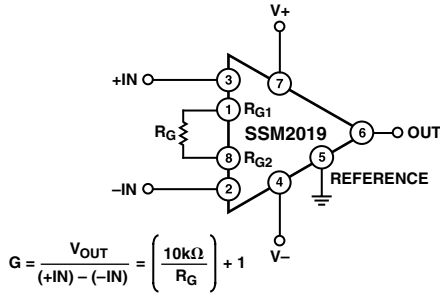

Figure 1. Basic Circuit Connections

## GAIN

The SSM2019 only requires a single external resistor to set the voltage gain. The voltage gain,  $G$ , is:

$$G = \frac{10\text{ k}\Omega}{R_G} + 1$$

and the external gain resistor,  $R_G$ , is:

$$R_G = \frac{10\text{ k}\Omega}{G - 1}$$

For convenience, Table I lists various values of  $R_G$  for common gain levels.

Table I. Values of  $R_G$  for Various Gain Levels

$R_G$ ( $\Omega$ )	$A_v$	dB
NC	1	0
4.7 k	3.2	10
1.1 k	10	20
330	31.3	30
100	100	40
32	314	50
10	1000	60

The voltage gain can range from 1 to 3500. A gain set resistor is not required for unity gain applications. Metal film or wire-wound resistors are recommended for best results.

The total gain accuracy of the SSM2019 is determined by the tolerance of the external gain set resistor,  $R_G$ , combined with the gain equation accuracy of the SSM2019. Total gain drift combines the mismatch of the external gain set resistor drift with that of the internal resistors (20 ppm/ $^{\circ}$ C typ).

Bandwidth of the SSM2019 is relatively independent of gain, as shown in Figure 2. For a voltage gain of 1000, the SSM2019 has a small-signal bandwidth of 200 kHz. At unity gain, the bandwidth of the SSM2019 exceeds 4 MHz.

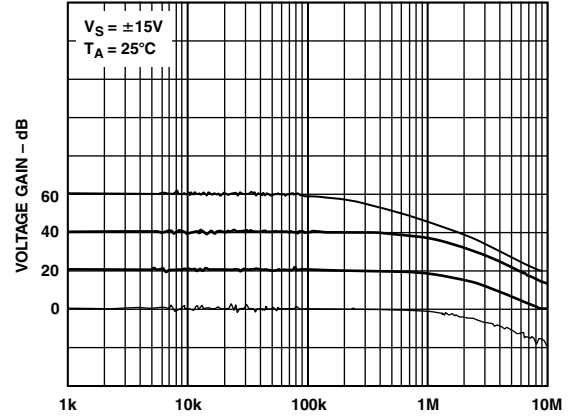

Figure 2. Bandwidth for Various Values of Gain

## NOISE PERFORMANCE

The SSM2019 is a very low noise audio preamplifier exhibiting a typical voltage noise density of only 1 nV/ $\sqrt{\text{Hz}}$  at 1 kHz. The exceptionally low noise characteristics of the SSM2019 are in part achieved by operating the input transistors at high collector currents since the voltage noise is inversely proportional to the square root of the collector current. Current noise, however, is directly proportional to the square root of the collector current. As a result, the outstanding voltage noise performance of the SSM2019 is obtained at the expense of current noise performance. At low preamplifier gains, the effect of the SSM2019 voltage and current noise is insignificant.

The total noise of an audio preamplifier channel can be calculated by:

$$E_n = \sqrt{e_n^2 + (i_n R_S)^2 + e_t^2}$$

where:

$E_n$  = total input referred noise

$e_n$  = amplifier voltage noise

$i_n$  = amplifier current noise

$R_S$  = source resistance

$e_t$  = source resistance thermal noise

For a microphone preamplifier, using a typical microphone impedance of 150  $\Omega$ , the total input referred noise is:

$$E_n = \sqrt{(1\text{ nV}/\sqrt{\text{Hz}})^2 + 2(pA/\sqrt{\text{Hz}} \times 150\ \Omega)^2 + (1.6\text{ nV}/\sqrt{\text{Hz}})^2} = 1.93\text{ nV}/\sqrt{\text{Hz}} @ 1\text{ kHz}$$

where:

$e_n = 1\text{ nV}/\sqrt{\text{Hz}} @ 1\text{ kHz}$ , SSM2019  $e_n$

$i_n = 2\text{ pA}/\sqrt{\text{Hz}} @ 1\text{ kHz}$ , SSM2019  $i_n$

$R_S = 150\ \Omega$ , microphone source impedance

$e_t = 1.6\text{ nV}/\sqrt{\text{Hz}} @ 1\text{ kHz}$ , microphone thermal noise

This total noise is extremely low and makes the SSM2019 virtually transparent to the user.

## INPUTS

The SSM2019 has protection diodes across the base emitter junctions of the input transistors. These prevent accidental avalanche breakdown, which could seriously degrade noise performance. Additional clamp diodes are also provided to prevent the inputs from being forced too far beyond the supplies.

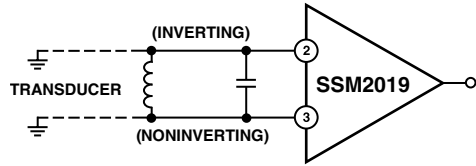

a. Single-Ended

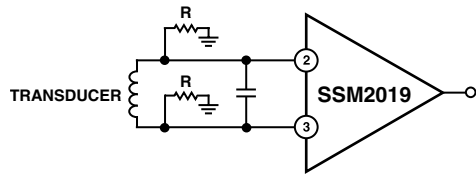

b. Pseudo-Differential

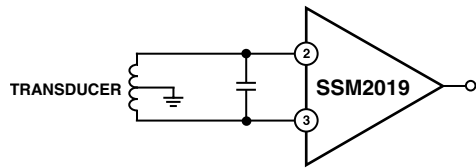

c. True Differential

Figure 3. Three Ways of Interfacing Transducers for High Noise Immunity

Although the SSM2019 inputs are fully floating, care must be exercised to ensure that both inputs have a dc bias connection capable of maintaining them within the input common-mode range. The usual method of achieving this is to ground one side of the transducer as in Figure 3a. An alternative way is to float the transducer and use two resistors to set the bias point as in Figure 3b. The value of these resistors can be up to 10 k $\Omega$ , but they should be kept as small as possible to limit common-mode pickup. Noise contribution by resistors is negligible since it is attenuated by the transducer's impedance. Balanced transducers give the best noise immunity and interface directly as in Figure 3c.

For stability, it is required to put an RF bypass capacitor directly across the inputs, as shown in Figures 3 and 4. This capacitor should be placed as close as possible to the input terminals. Good RF practice should also be followed in layout and power supply bypassing, since the SSM2019 uses very high bandwidth devices.

## REFERENCE TERMINAL

The output signal is specified with respect to the reference terminal, which is normally connected to analog ground. The reference may also be used for offset correction or level shifting. A reference source resistance will reduce the common-mode rejection by the ratio of 5 k $\Omega$ / $R_{REF}$ . If the reference source resistance is 1  $\Omega$ , then the CMR will be reduced to 74 dB (5 k $\Omega$ /1  $\Omega$  = 74 dB).

## COMMON-MODE REJECTION

Ideally, a microphone preamplifier responds to only the difference between the two input signals and rejects common-mode voltages and noise. In practice, there is a small change in output voltage when both inputs experience the same common-mode voltage change; the ratio of these voltages is called the common-mode gain. Common-mode rejection (CMR) is the logarithm of the ratio of differential-mode gain to common-mode gain, expressed in dB.

## PHANTOM POWERING

A typical phantom microphone powering circuit is shown in Figure 4. Z1 to Z4 provide transient overvoltage protection for the SSM2019 whenever microphones are plugged in or unplugged.

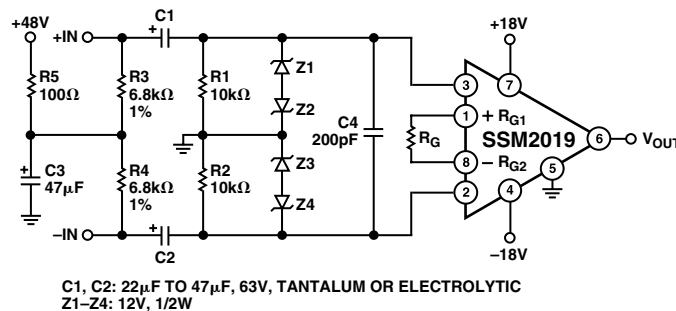

Figure 4. SSM2019 in Phantom Powered Microphone Circuit

# SSM2019

## BUS SUMMING AMPLIFIER

In addition to its use as a microphone preamplifier, the SSM2019 can be used as a very low noise summing amplifier. Such a circuit is particularly useful when many medium impedance outputs are summed together to produce a high effective noise gain.

The principle of the summing amplifier is to ground the SSM2019 inputs. Under these conditions, Pins 1 and 8 are ac virtual grounds sitting about 0.55 V below ground. To remove the 0.55 V offset, the circuit of Figure 5 is recommended.

A2 forms a “servo” amplifier feeding the SSM2019 inputs. This places Pins 1 and 8 at a true dc virtual ground. R4 in conjunction with C2 removes the voltage noise of A2, and in fact just about any operational amplifier will work well here since it is removed from the signal path. If the dc offset at Pins 1 and 8 is not too

critical, then the servo loop can be replaced by the diode biasing scheme of Figure 5. If ac coupling is used throughout, then Pins 2 and 3 may be directly grounded.

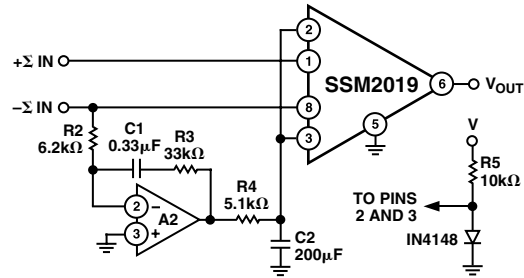
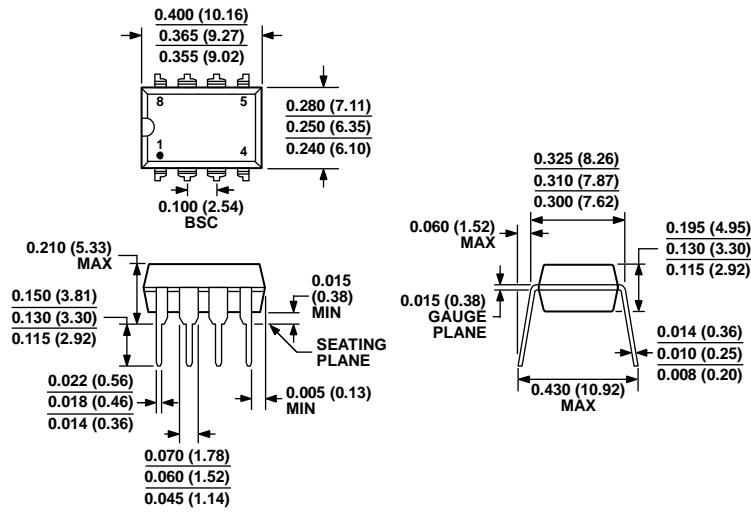

Figure 5. Bus Summing Amplifier



OUTLINE DIMENSIONS



COMPLIANT TO JEDEC STANDARDS MS-001  
 CONTROLLING DIMENSIONS ARE IN INCHES; MILLIMETER DIMENSIONS (IN PARENTHESES) ARE ROUNDED-OFF INCH EQUIVALENTS FOR REFERENCE ONLY AND ARE NOT APPROPRIATE FOR USE IN DESIGN. CORNER LEADS MAY BE CONFIGURED AS WHOLE OR HALF LEADS.

Figure 6. 8-Lead Plastic Dual In-Line Package [PDIP] Narrow Body (N-8)

Dimensions shown in inches and (millimeters)

070606-A

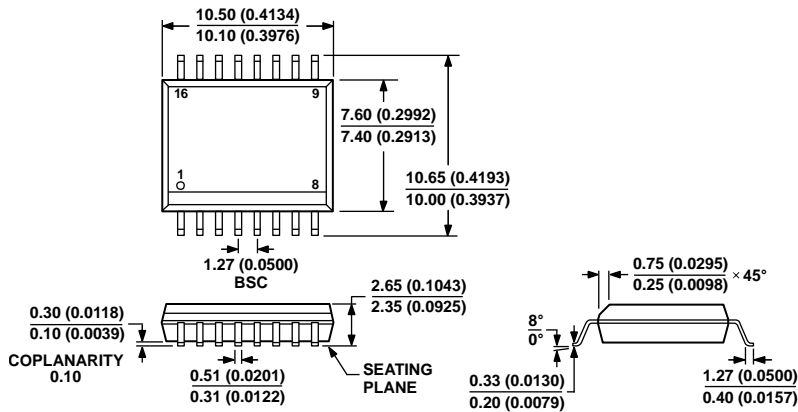

COMPLIANT TO JEDEC STANDARDS MS-013-AA  
 CONTROLLING DIMENSIONS ARE IN MILLIMETERS; INCH DIMENSIONS (IN PARENTHESES) ARE ROUNDED-OFF MILLIMETER EQUIVALENTS FOR REFERENCE ONLY AND ARE NOT APPROPRIATE FOR USE IN DESIGN.

Figure 7. 16-Lead Standard Small Outline Package [SOIC\_W] Wide Body (RW-16)

Dimensions shown in millimeters and (inches)

03-27-2007-B

# SSM2019

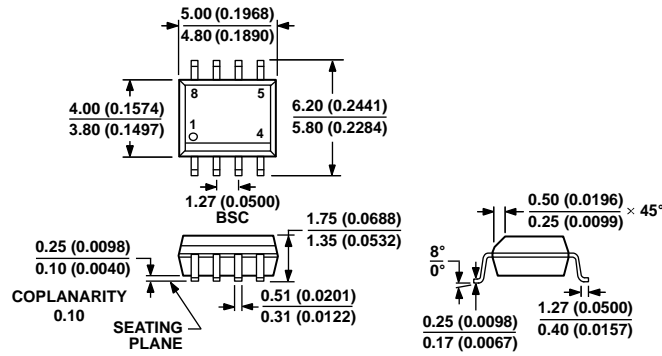

COMPLIANT TO JEDEC STANDARDS MS-012-AA  
 CONTROLLING DIMENSIONS ARE IN MILLIMETERS; INCH DIMENSIONS  
 (IN PARENTHESES) ARE ROUNDED-OFF MILLIMETER EQUIVALENTS FOR  
 REFERENCE ONLY AND ARE NOT APPROPRIATE FOR USE IN DESIGN.

Figure 8. 8-Lead Standard Small Outline Package [SOIC\_N]  
 Narrow Body  
 (RN-8)

Dimensions shown in millimeters and (inches)

012407-A

## ORDERING GUIDE

Model <sup>1</sup>	Temperature Range	Package Description	Package Option
SSM2019BNZ	-40°C to +85°C	8-Lead PDIP	N-8
SSM2019BRNZ	-40°C to +85°C	8-Lead SOIC_N	R-8
SSM2019BRNZRL	-40°C to +85°C	8-Lead SOIC_N, REEL	R-8
SSM2019BRWZ	-40°C to +85°C	16-Lead SOIC_W	RW-16
SSM2019BRWZRL	-40°C to +85°C	16-Lead SOIC_W, REEL	RW-16

<sup>1</sup> Z = RoHS Compliant Part

## REVISION HISTORY

### 6/11—Rev. 0 to Rev. A

Updated Outline Dimensions .....	9
Changes to Ordering Guide .....	10

### 2/03—Revision 0: Initial Version