

## TRANSITION-MODE PFC CONTROLLER

### 1 Features

- REALISED IN BCD TECHNOLOGY
- TRANSITION-MODE CONTROL OF PFC PRE-REGULATORS
- PROPRIETARY MULTIPLIER DESIGN FOR MINIMUM THD OF AC INPUT CURRENT
- VERY PRECISE ADJUSTABLE OUTPUT OVERVOLTAGE PROTECTION
- ULTRA-LOW ( $\leq 70\mu\text{A}$ ) START-UP CURRENT
- LOW ( $\leq 4\text{ mA}$ ) QUIESCENT CURRENT
- EXTENDED IC SUPPLY VOLTAGE RANGE
- ON-CHIP FILTER ON CURRENT SENSE
- DISABLE FUNCTION
- 1% (@  $T_j = 25\text{ }^\circ\text{C}$ ) INTERNAL REFERENCE VOLTAGE
- -600/+800mA TOTEM POLE GATE DRIVER WITH UVLO PULL-DOWN AND VOLTAGE CLAMP
- DIP-8/SO-8 PACKAGES ECOPACK®

#### 1.1 APPLICATIONS

- PFC PRE-REGULATORS FOR:
  - IEC61000-3-2 COMPLIANT SMPS (TV,

Figure 1. Packages



Table 1. Order Codes

Part Number	Package
L6562N	DIP-8
L6562D	SO-8
L6562DTR	Tape & Reel

- DESKTOP PC, MONITOR) UP TO 300W
- HI-END AC-DC ADAPTER/CHARGER
- ENTRY LEVEL SERVER & WEB SERVER

### 2 Description

The L6562 is a current-mode PFC controller operating in Transition Mode (TM). Pin-to-pin compatible with the predecessor L6561, it offers improved performance.

Figure 2. Block Diagram

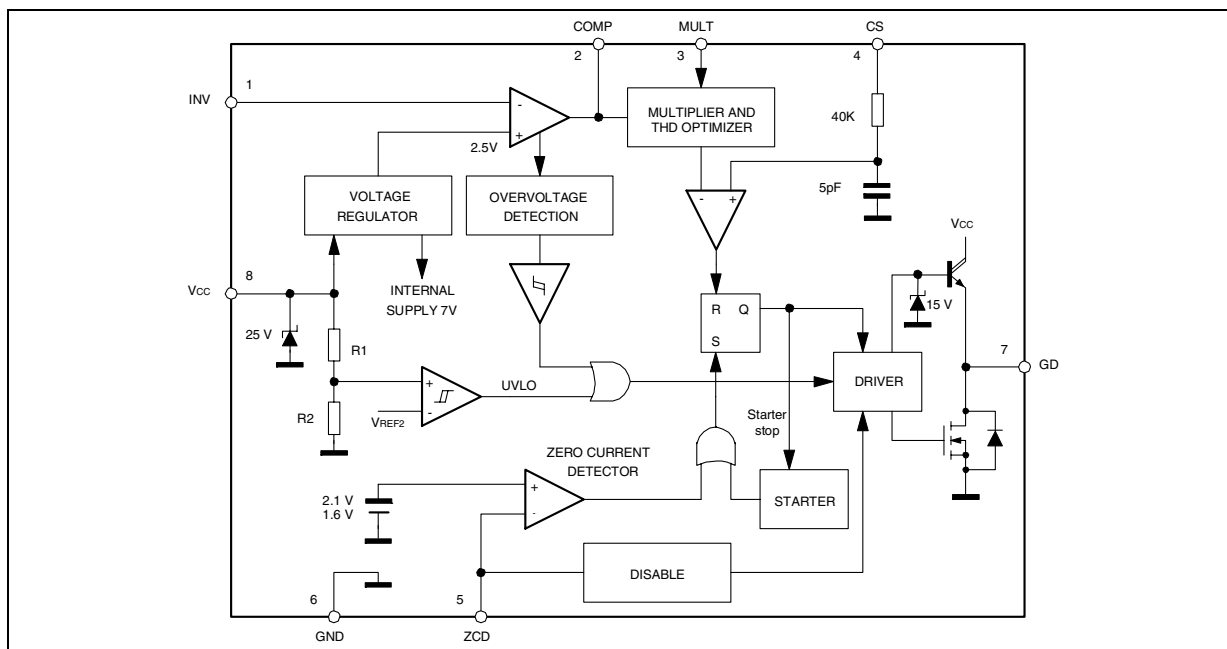

## 2 Description (continued)

The highly linear multiplier includes a special circuit, able to reduce AC input current distortion, that allows wide-range-mains operation with an extremely low THD, even over a large load range.

The output voltage is controlled by means of a voltage-mode error amplifier and a precise (1% @  $T_j = 25^\circ\text{C}$ ) internal voltage reference.

The device features extremely low consumption ( $\leq 70 \mu\text{A}$  before start-up and  $< 4 \text{ mA}$  running) and includes a disable function suitable for IC remote ON/OFF, which makes it easier to comply with energy saving norms (Blue Angel, EnergyStar, Energy2000, etc.).

An effective two-step OVP enables to safely handle overvoltages either occurring at start-up or resulting from load disconnection.

The totem-pole output stage, capable of 600 mA source and 800 mA sink current, is suitable for big MOS-FET or IGBT drive which, combined with the other features, makes the device an excellent low-cost solution for EN61000-3-2 compliant SMPS's up to 300W.

**Table 2. Absolute Maximum Ratings**

Symbol	Pin	Parameter	Value	Unit
$V_{CC}$	8	IC Supply voltage ( $I_{CC} = 20 \text{ mA}$ )	self-limited	V
---	1 to 4	Analog Inputs & Outputs	-0.3 to 8	V
$I_{ZCD}$	5	Zero Current Detector Max. Current	-50 (source) 10 (sink)	mA
$P_{tot}$		Power Dissipation @ $T_{amb} = 50^\circ\text{C}$ (DIP-8) (SO-8)	1 0.65	W
$T_j$		Junction Temperature Operating range	-40 to 150	$^\circ\text{C}$
$T_{stg}$		Storage Temperature	-55 to 150	$^\circ\text{C}$

**Figure 3. Pin Connection (Top view)**

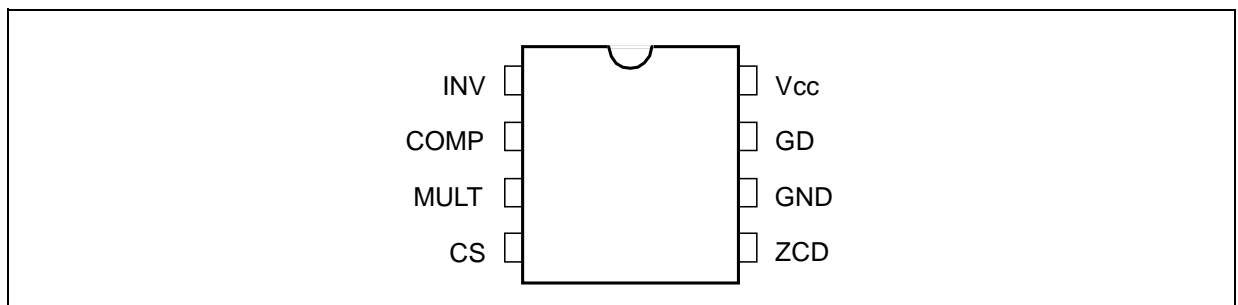

**Table 3. Thermal Data**

Symbol	Parameter	SO8	Minidip	Unit
$R_{th\ j-amb}$	Max. Thermal Resistance, Junction-to-ambient	150	100	$^\circ\text{C}/\text{W}$

Table 4. Pin Description

N°	Pin	Function
1	INV	Inverting input of the error amplifier. The information on the output voltage of the PFC pre-regulator is fed into the pin through a resistor divider.
2	COMP	Output of the error amplifier. A compensation network is placed between this pin and INV (pin #1) to achieve stability of the voltage control loop and ensure high power factor and low THD.
3	MULT	Main input to the multiplier. This pin is connected to the rectified mains voltage via a resistor divider and provides the sinusoidal reference to the current loop.
4	CS	Input to the PWM comparator. The current flowing in the MOSFET is sensed through a resistor, the resulting voltage is applied to this pin and compared with an internal sinusoidal-shaped reference, generated by the multiplier, to determine MOSFET's turn-off.
5	ZCD	Boost inductor's demagnetization sensing input for transition-mode operation. A negative-going edge triggers MOSFET's turn-on.
6	GND	Ground. Current return for both the signal part of the IC and the gate driver.
7	GD	Gate driver output. The totem pole output stage is able to drive power MOSFET's and IGBT's with a peak current of 600 mA source and 800 mA sink. The high-level voltage of this pin is clamped at about 12V to avoid excessive gate voltages in case the pin is supplied with a high V <sub>CC</sub> .
8	V <sub>CC</sub>	Supply Voltage of both the signal part of the IC and the gate driver. The supply voltage upper limit is extended to 22V min. to provide more headroom for supply voltage changes.

Table 5. Electrical Characteristics

(T<sub>j</sub> = -25 to 125°C, V<sub>CC</sub> = 12, C<sub>O</sub> = 1 nF; unless otherwise specified)

Symbol	Parameter	Test Condition	Min.	Typ.	Max.	Unit
<b>SUPPLY VOLTAGE</b>						
V <sub>CC</sub>	Operating range	After turn-on	10.3		22	V
V <sub>CCOn</sub>	Turn-on threshold	(1)	11	12	13	V
V <sub>CCOff</sub>	Turn-off threshold	(1)	8.7	9.5	10.3	V
Hys	Hysteresis		2.2		2.8	V
V <sub>Z</sub>	Zener Voltage	I <sub>CC</sub> = 20 mA	22	25	28	V
<b>SUPPLY CURRENT</b>						
I <sub>start-up</sub>	Start-up Current	Before turn-on, V <sub>CC</sub> = 11V		40	70	μA
I <sub>q</sub>	Quiescent Current	After turn-on		2.5	3.75	mA
I <sub>CC</sub>	Operating Supply Current	@ 70 kHz		3.5	5	mA
I <sub>q</sub>	Quiescent Current	During OVP (either static or dynamic) or V <sub>ZCD</sub> = 150 mV			2.2	mA
<b>MULTIPLIER INPUT</b>						
I <sub>MULT</sub>	Input Bias Current	V <sub>VFF</sub> = 0 to 4 V			-1	μA
V <sub>MULT</sub>	Linear Operation Range		0 to 3			V
$\frac{\Delta V_{CS}}{\Delta V_{MULT}}$	Output Max. Slope	V <sub>MULT</sub> = 0 to 0.5V V <sub>COMP</sub> = Upper clamp	1.65	1.9		V/V
K	Gain (2)	V <sub>MULT</sub> = 1 V, V <sub>COMP</sub> = 4 V	0.5	0.6	0.7	1/V
<b>ERROR AMPLIFIER</b>						
V <sub>INV</sub>	Voltage Feedback Input Threshold	T <sub>j</sub> = 25 °C	2.465	2.5	2.535	V
		10.3 V < V <sub>CC</sub> < 22 V (1)	2.44		2.56	
	Line Regulation	V <sub>CC</sub> = 10.3 V to 22V		2	5	mV
I <sub>INV</sub>	Input Bias Current	V <sub>INV</sub> = 0 to 3 V			-1	μA

**Table 5. Electrical Characteristics** (continued)(T<sub>j</sub> = -25 to 125°C, V<sub>CC</sub> = 12, C<sub>O</sub> = 1 nF; unless otherwise specified)

Symbol	Parameter	Test Condition	Min.	Typ.	Max.	Unit
G <sub>v</sub>	Voltage Gain	Open loop	60	80		dB
GB	Gain-Bandwidth Product			1		MHz
I <sub>COMP</sub>	Source Current	V <sub>COMP</sub> = 4V, V <sub>INV</sub> = 2.4 V	-2	-3.5	-5	mA
	Sink Current	V <sub>COMP</sub> = 4V, V <sub>INV</sub> = 2.6 V	2.5	4.5		mA
V <sub>COMP</sub>	Upper Clamp Voltage	I <sub>SOURCE</sub> = 0.5 mA	5.3	5.7	6	V
	Lower Clamp Voltage	I <sub>SINK</sub> = 0.5 mA <sup>(1)</sup>	2.1	2.25	2.4	V
<b>CURRENT SENSE COMPARATOR</b>						
I <sub>CS</sub>	Input Bias Current	V <sub>CS</sub> = 0			-1	μA
t <sub>d(H-L)</sub>	Delay to Output			200	350	ns
V <sub>CS clamp</sub>	Current sense reference clamp	V <sub>COMP</sub> = Upper clamp	1.6	1.7	1.8	V
V <sub>CSoffset</sub>	Current sense offset	V <sub>MULT</sub> = 0		30		mV
		V <sub>MULT</sub> = 2.5V		5		
<b>ZERO CURRENT DETECTOR</b>						
V <sub>ZCDH</sub>	Upper Clamp Voltage	I <sub>ZCD</sub> = 2.5 mA	5.0	5.7	6.5	V
V <sub>ZCDL</sub>	Lower Clamp Voltage	I <sub>ZCD</sub> = -2.5 mA	0.3	0.65	1	V
V <sub>ZCDA</sub>	Arming Voltage (positive-going edge)	<sup>(3)</sup>		2.1		V
V <sub>ZCDT</sub>	Triggering Voltage (negative-going edge)	<sup>(3)</sup>		1.6		V
I <sub>ZCDb</sub>	Input Bias Current	V <sub>ZCD</sub> = 1 to 4.5 V		2		μA
I <sub>ZCDsrc</sub>	Source Current Capability		-2.5		-5.5	mA
I <sub>ZCDsnk</sub>	Sink Current Capability		2.5			mA
V <sub>ZCDdis</sub>	Disable threshold		150	200	250	mV
V <sub>ZCDen</sub>	Restart threshold				350	mV
I <sub>ZCDres</sub>	Restart Current after Disable		30	75		μA
<b>STARTER</b>						
t <sub>START</sub>	Start Timer period		75	130	300	μs
<b>OUTPUT OVERVOLTAGE</b>						
I <sub>OVP</sub>	Dynamic OVP triggering current		35	40	45	μA
H <sub>ys</sub>	Hysteresis	<sup>(3)</sup>		30		μA
	Static OVP threshold	<sup>(1)</sup>	2.1	2.25	2.4	V
<b>GATE DRIVER</b>						
V <sub>OH</sub>	Dropout Voltage	I <sub>GDSOURCE</sub> = 20 mA		2	2.6	
		I <sub>GDSOURCE</sub> = 200 mA		2.5	3	V
V <sub>OL</sub>		I <sub>GDSINK</sub> = 200 mA		0.9	1.9	V
t <sub>f</sub>	Voltage Fall Time			30	70	ns
t <sub>r</sub>	Voltage Rise Time			40	80	ns
V <sub>Oclamp</sub>	Output clamp voltage	I <sub>GDSOURCE</sub> = 5mA; V <sub>CC</sub> = 20V	10	12	15	V
	UVLO saturation	V <sub>CC</sub> = 0 to V <sub>CCcon</sub> , I <sub>sink</sub> =10mA			1.1	V

(1) All parameters are in tracking

(2) The multiplier output is given by: V<sub>CS</sub> = K · V<sub>MULT</sub> · (V<sub>COMP</sub> - 2.5)

(3) Parameters guaranteed by design, functionality tested in production.

### 3 Typical Electrical Characteristics

Figure 4. Supply current vs. Supply voltage

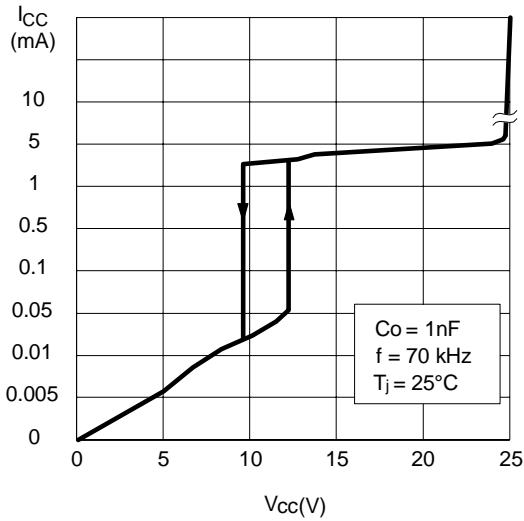

Figure 6. IC consumption vs.  $T_j$

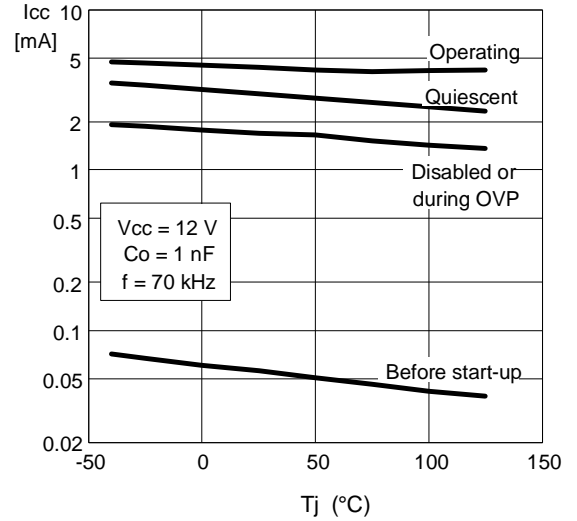

Figure 5. Start-up & UVLO vs.  $T_j$

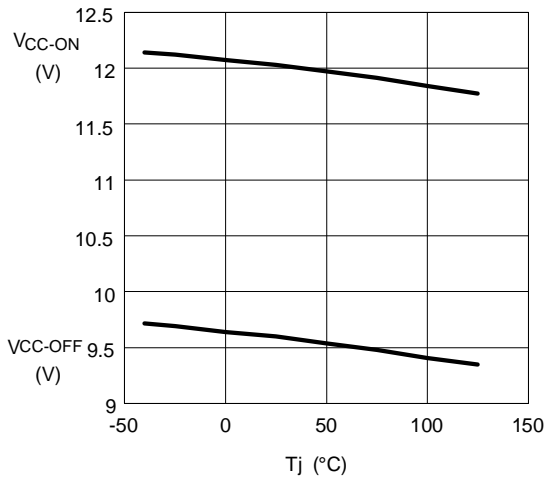

Figure 7.  $V_{CCZ}$  Zener voltage vs.  $T_j$

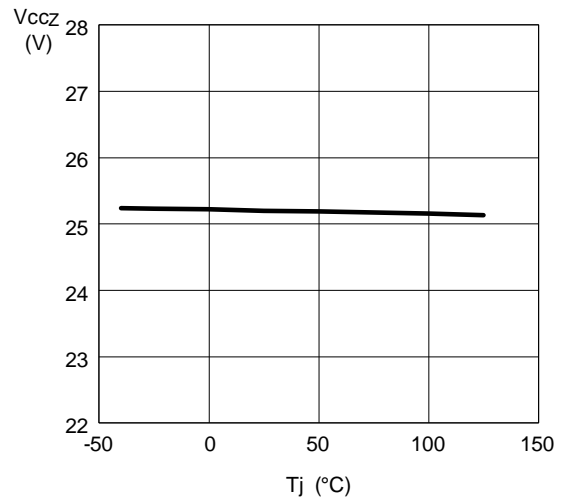

Figure 8. Feedback reference vs.  $T_j$

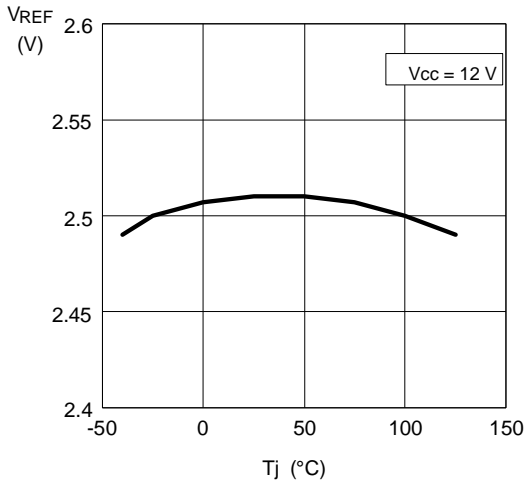

Figure 11. Delay-to-output vs.  $T_j$

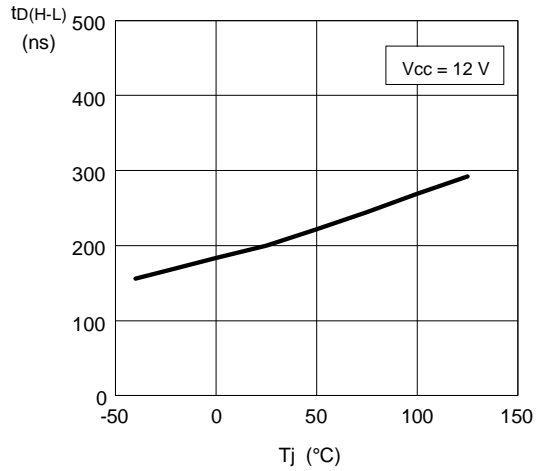

Figure 9. OVP current vs.  $T_j$

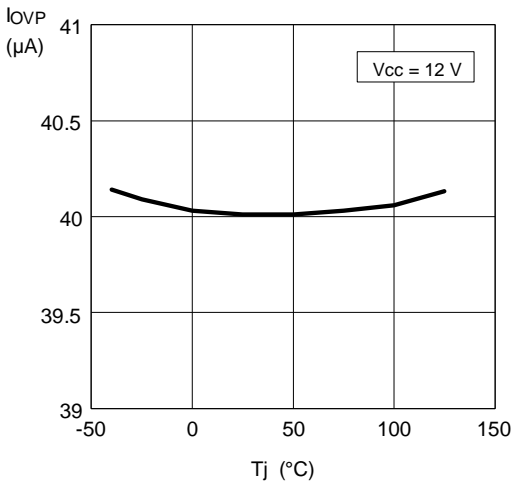

Figure 12. Multiplier characteristic

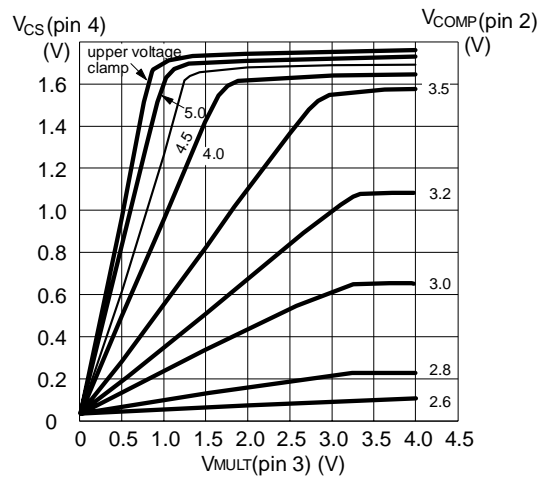

Figure 10. E/A output clamp levels vs.  $T_j$

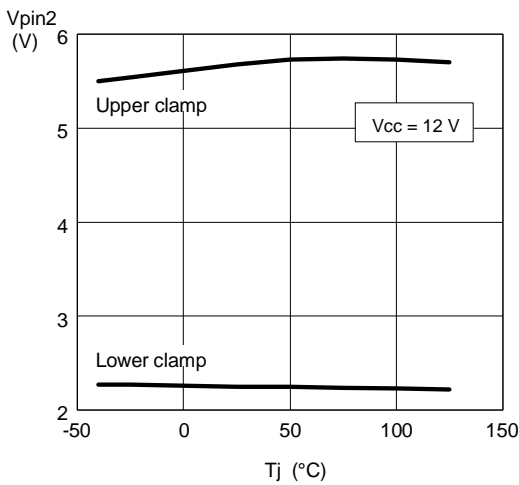

Figure 13. Multiplier gain vs.  $T_j$

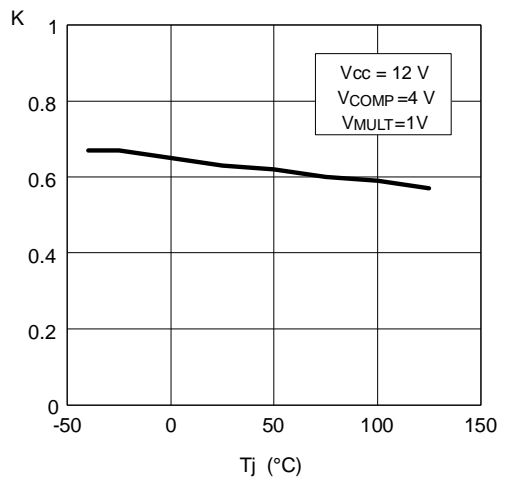

Figure 14. Vcs clamp vs. Tj

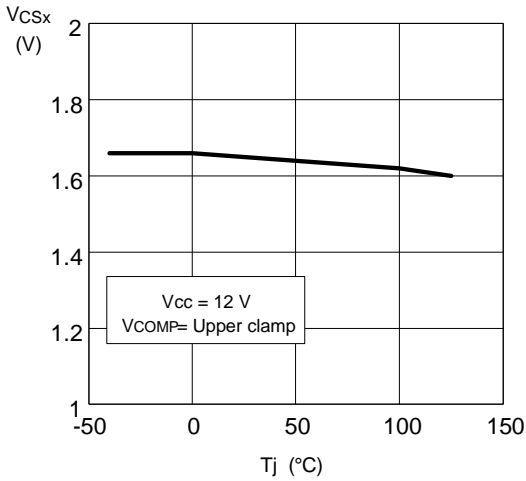

Figure 17. ZCD source capability vs. Tj

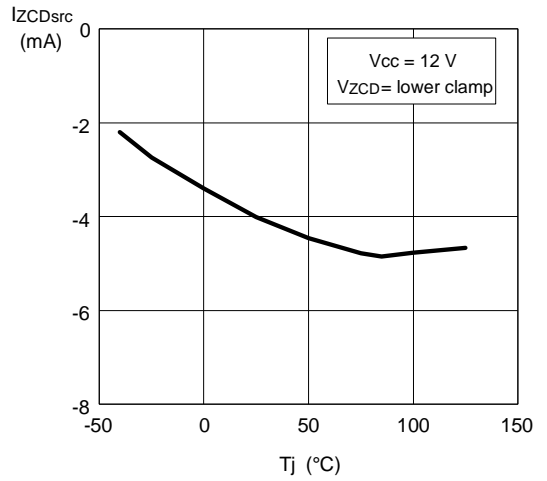

Figure 15. Start-up timer vs. Tj

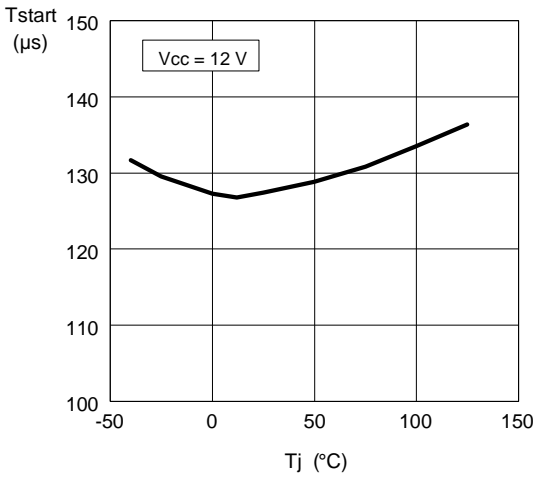

Figure 18. Gate-drive output low saturation

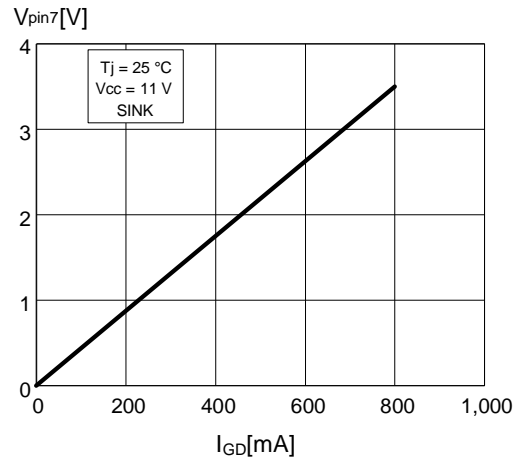

Figure 16. ZCD clamp levels vs. Tj

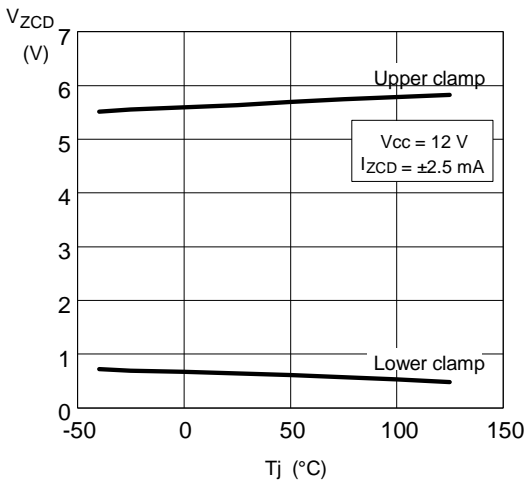

Figure 19. Gate-drive output high saturation

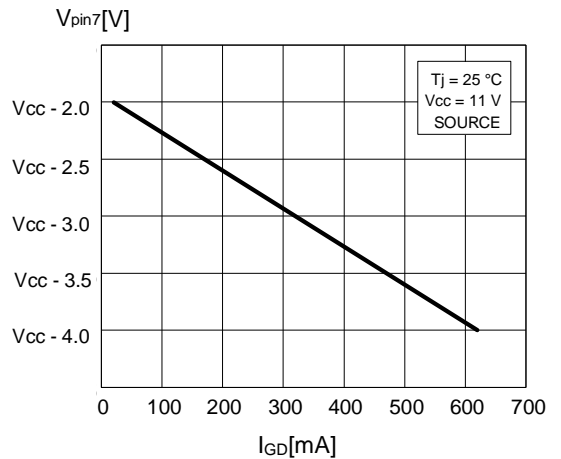

Figure 20. Gate-drive clamp vs. T<sub>j</sub>

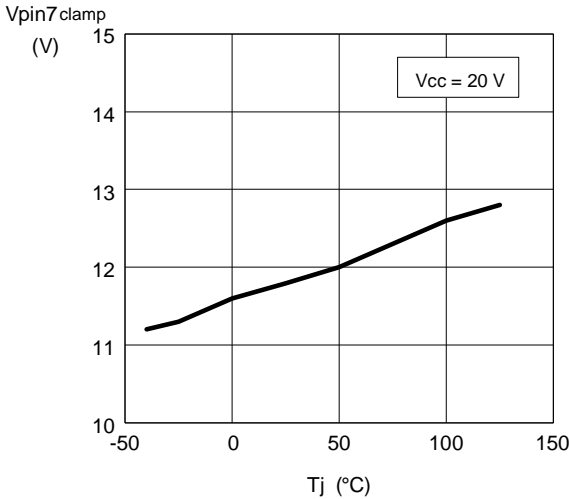
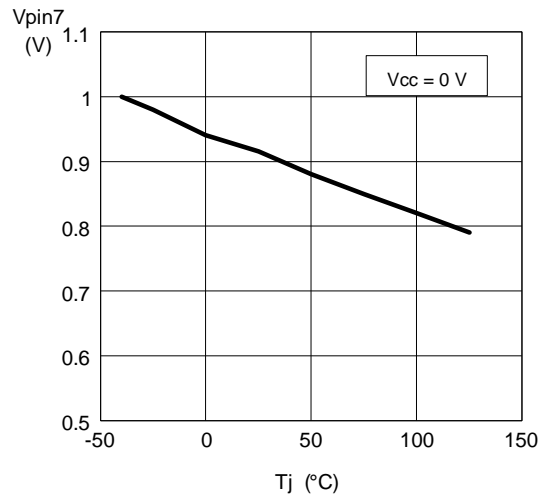

Figure 21. UVLO saturation vs. T<sub>j</sub>



## 4 Application Information

### 4.1 Overvoltage protection

Under steady-state conditions, the voltage control loop keeps the output voltage V<sub>o</sub> of a PFC pre-regulator close to its nominal value, set by the resistors R<sub>1</sub> and R<sub>2</sub> of the output divider. Neglecting ripple components, the current through R<sub>1</sub>, I<sub>R1</sub>, equals that through R<sub>2</sub>, I<sub>R2</sub>. Considering that the non-inverting input of the error amplifier is internally referenced at 2.5V, also the voltage at pin INV will be 2.5V, then:

$$I_{R2} = \frac{2.5}{R2} = I_{R1} = \frac{V_o - 2.5}{R1} .$$

If the output voltage experiences an abrupt change ΔV<sub>o</sub> > 0 due to a load drop, the voltage at pin INV will be kept at 2.5V by the local feedback of the error amplifier, a network connected between pins INV and COMP that introduces a long time constant to achieve high PF (this is why ΔV<sub>o</sub> can be large). As a result, the current through R<sub>2</sub> will remain equal to 2.5/R<sub>2</sub> but that through R<sub>1</sub> will become:

$$I'_{R1} = \frac{V_o - 2.5 + \Delta V_o}{R1} .$$

The difference current ΔI<sub>R1</sub>=I'<sub>R1</sub>-I<sub>R2</sub>=I'<sub>R1</sub>-I<sub>R1</sub>=ΔV<sub>o</sub>/R<sub>1</sub> will flow through the compensation network and enter the error amplifier output (pin COMP). This current is monitored inside the L6562 and if it reaches about 37 μA the output voltage of the multiplier is forced to decrease, thus smoothly reducing the energy delivered to the output. As the current exceeds 40 μA, the OVP is triggered (Dynamic OVP): the gate-drive is forced low to switch off the external power transistor and the IC put in an idle state. This condition is maintained until the current falls below approximately 10 μA, which re-enables the internal starter and allows switching to restart. The output ΔV<sub>o</sub> that is able to trigger the Dynamic OVP function is then:

$$\Delta V_o = R1 \cdot 40 \cdot 10^{-6} .$$

An important advantage of this technique is that the OV level can be set independently of the regulated output voltage: the latter depends on the ratio of R<sub>1</sub> to R<sub>2</sub>, the former on the individual value of R<sub>1</sub>. Another advantage is the precision: the tolerance of the detection current is 12%, that is 12% tolerance on ΔV<sub>o</sub>. Since ΔV<sub>o</sub> << V<sub>o</sub>, the tolerance on the absolute value will be proportionally reduced.

Example: V<sub>o</sub> = 400 V, ΔV<sub>o</sub> = 40 V. Then: R<sub>1</sub>=40V/40μA=1MΩ; R<sub>2</sub>=1MΩ·2.5/(400-2.5)=6.289kΩ. The tolerance on the OVP level due to the L6562 will be 40·0.12=4.8V, that is 1.2% of the regulated value.



When the load of a PFC pre-regulator is very low, the output voltage tends to stay steadily above the nominal value, which cannot be handled by the Dynamic OVP. If this occurs, however, the error amplifier output will saturate low; hence, when this is detected, the external power transistor is switched off and the IC put in an idle state (Static OVP). Normal operation is resumed as the error amplifier goes back into its linear region. As a result, the L6562 will work in burst-mode, with a repetition rate that can be very low.

When either OVP is activated the quiescent consumption of the IC is reduced to minimize the discharge of the Vcc capacitor and increase the hold-up capability of the IC supply system.

#### 4.2 THD optimizer circuit

The L6562 is equipped with a special circuit that reduces the conduction dead-angle occurring to the AC input current near the zero-crossings of the line voltage (crossover distortion). In this way the THD (Total Harmonic Distortion) of the current is considerably reduced.

A major cause of this distortion is the inability of the system to transfer energy effectively when the instantaneous line voltage is very low. This effect is magnified by the high-frequency filter capacitor placed after the bridge rectifier, which retains some residual voltage that causes the diodes of the bridge rectifier to be reverse-biased and the input current flow to temporarily stop.

**Figure 22. THD optimization: standard TM PFC controller (left side) and L6562 (right side)**

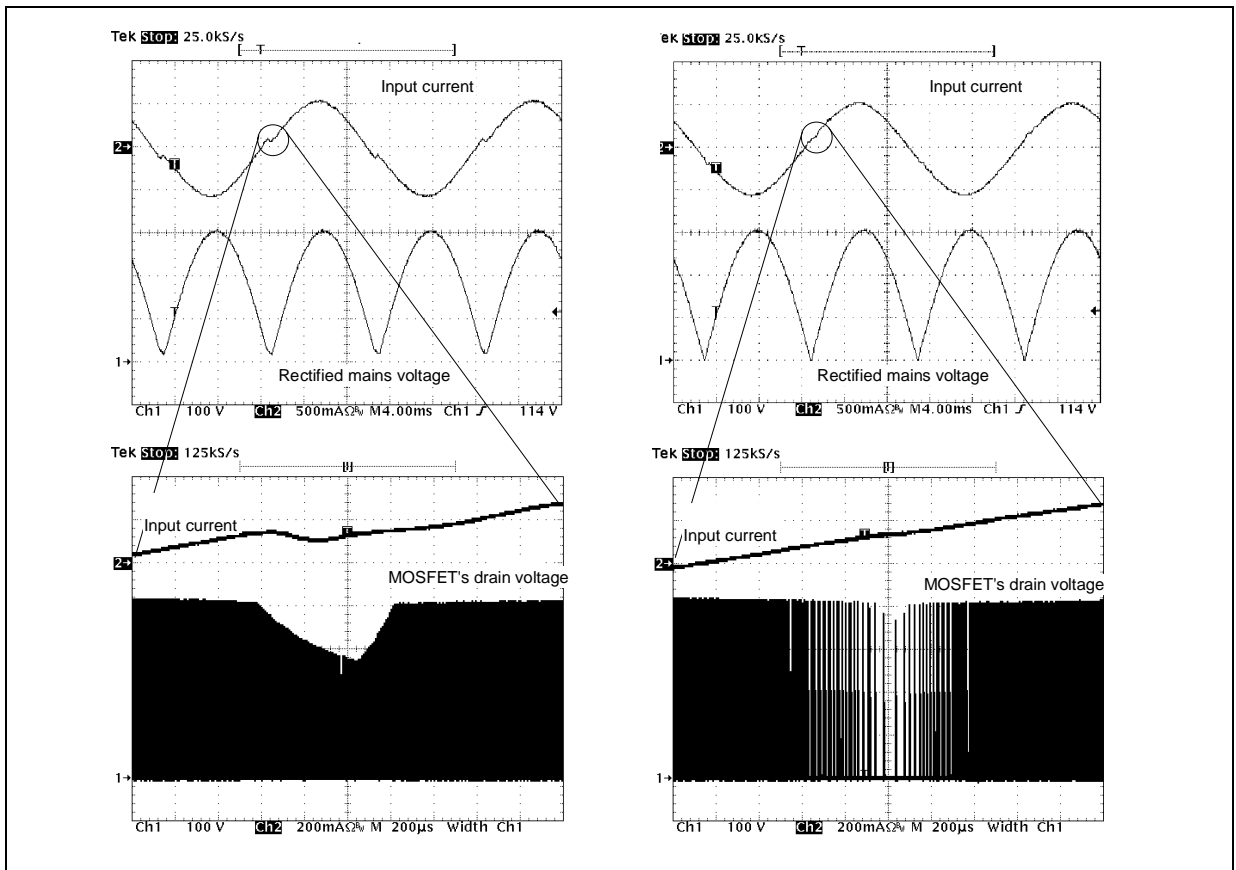

To overcome this issue the circuit embedded in the L6562 forces the PFC pre-regulator to process more energy near the line voltage zero-crossings as compared to that commanded by the control loop. This will result in both minimizing the time interval where energy transfer is lacking and fully discharging the high-frequency filter capacitor after the bridge. The effect of the circuit is shown in figure 23, where the key waveforms of a standard TM PFC controller are compared to those of the L6562.

Essentially, the circuit artificially increases the ON-time of the power switch with a positive offset added to



Figure 25. EVAL6562-80W: PCB and component layout (Top view, real size: 57 x 108 mm)

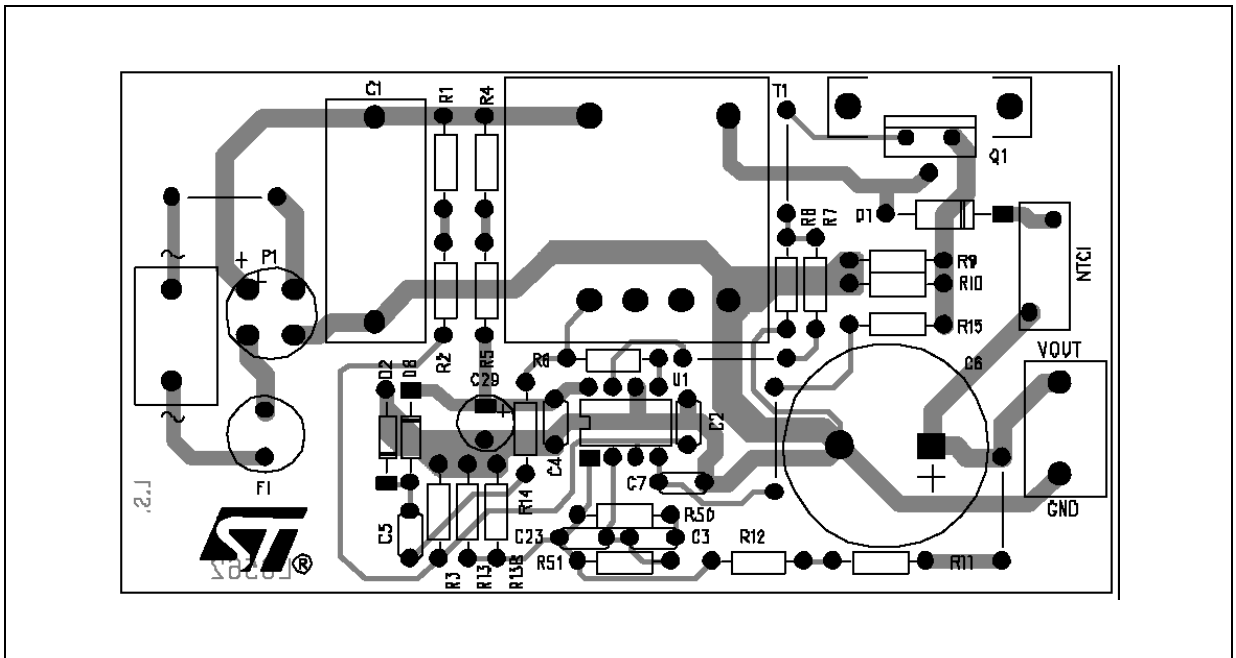

Table 6. EVAL6562N: Evaluation results at full load

Vin (V <sub>AC</sub> )	Pin (W)	Vo (V <sub>DC</sub> )	$\Delta V_o(V_{pk-pk})$	Po (W)	$\eta$ (%)	PF	THD (%)
85	86.4	394.79	12.8	80.16	92.8	0.998	3.6
110	84.6	394.86	12.8	80.20	94.8	0.996	4.2
135	83.8	394.86	12.8	80.20	95.7	0.991	4.9
175	83.2	394.87	15.5	80.20	96.4	0.981	6.5
220	82.9	394.87	15.7	80.20	96.7	0.956	7.8
265	82.7	394.87	15.9	80.20	97.0	0.915	9.2

Note: measurements done with the line filter shown in figure 23

Table 7. EVAL6562N: Evaluation results at half load

Vin (V <sub>AC</sub> )	Pin (W)	Vo (V <sub>DC</sub> )	$\Delta V_o(V_{pk-pk})$	Po (W)	$\eta$ (%)	PF	THD (%)
85	42.8	394.86	6.6	40.20	93.9	0.994	5.5
110	42.5	394.90	6.6	40.20	94.6	0.985	6.2
135	42.5	394.91	6.7	40.20	94.6	0.967	7.1
175	42.5	394.93	8.0	40.19	94.6	0.939	8.3
220	42.6	394.94	8.2	40.19	94.3	0.869	9.8
265	42.6	394.94	8.3	40.19	94.3	0.776	11.4

Note: measurements done with the line filter shown in figure 23

Table 8. EVAL6562N: No-load measurements

Vin (V <sub>AC</sub> )	Pin (W)	Vo (V <sub>DC</sub> )	$\Delta V_o (V_{pk-pk})$	Po (W)
85	0.4	396.77	0.45	0
110	0.3	396.82	0.55	0
135	0.3	396.83	0.60	0
175 (*)	0.4	396.90	1.00	0
220 (*)	0.4	396.95	1.40	0
265 (*)	0.5	396.98	1.65	0

(\*) V<sub>cc</sub> = 12V supplied externally

Figure 26. Line filter (not tested for EMI compliance) used for EVAL6562N evaluation

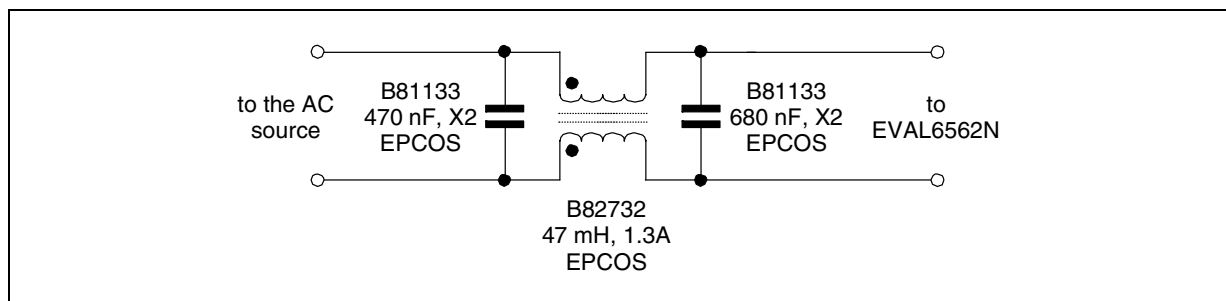

## 5 Package Information

In order to meet environmental requirements, ST offers these devices in ECOPACK<sup>®</sup> packages. These packages have a Lead-free second level interconnect. The category of second Level Interconnect is marked on the package and on the inner box label, in compliance with JEDEC Standard JESD97. The maximum ratings related to soldering conditions are also marked on the inner box label. ECOPACK is an ST trademark.

ECOPACK specifications are available at: [www.st.com](http://www.st.com).

**Figure 27. DIP-8 Mechanical Data & Package Dimensions**

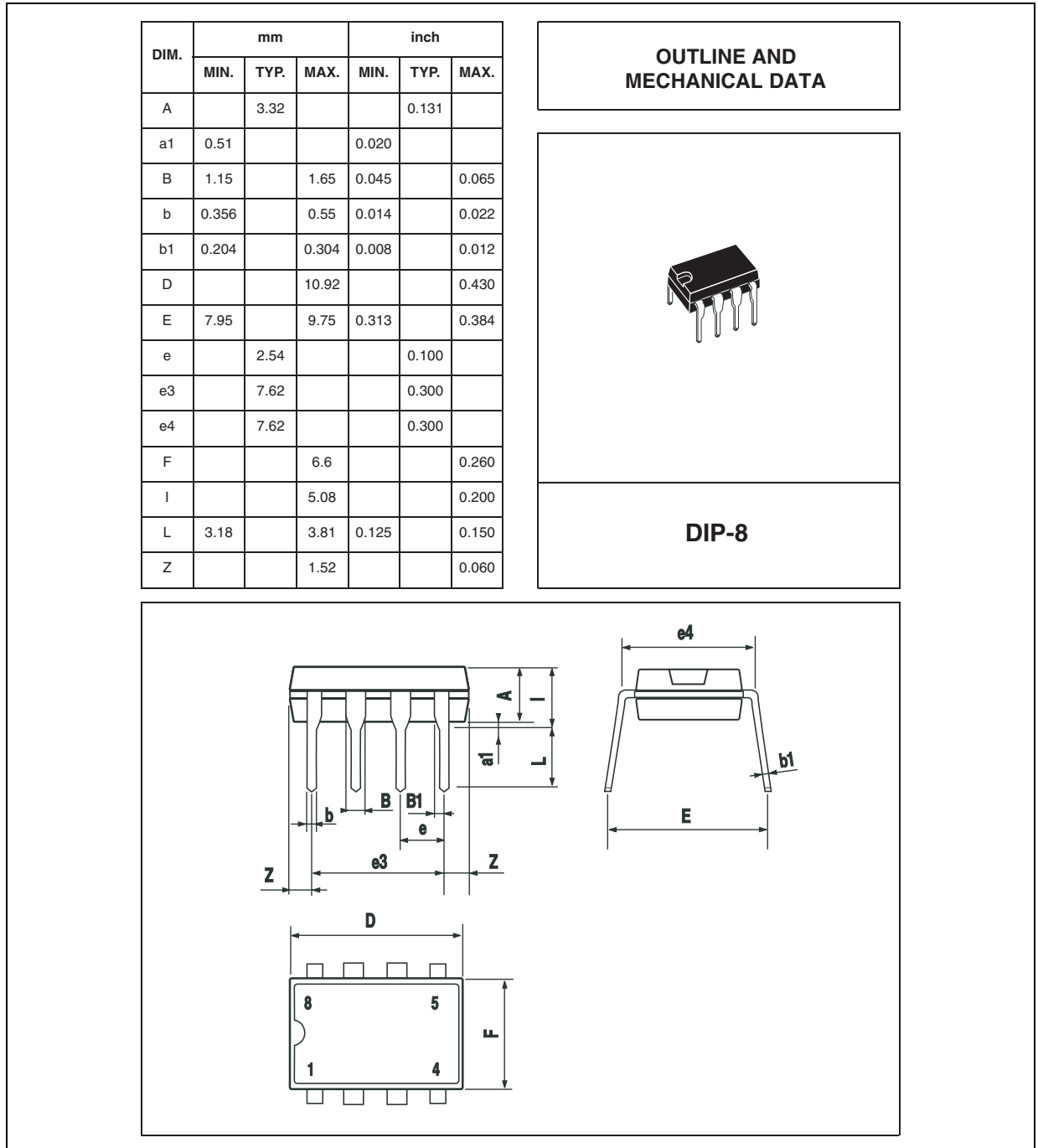
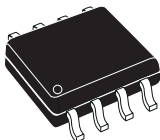

Figure 28. SO-8 Mechanical Data & Package Dimensions

DIM.	mm			inch		
	MIN.	TYP.	MAX.	MIN.	TYP.	MAX.
A	1.35		1.75	0.053		0.069
A1	0.10		0.25	0.004		0.010
A2	1.10		1.65	0.043		0.065
B	0.33		0.51	0.013		0.020
C	0.19		0.25	0.007		0.010
D (1)	4.80		5.00	0.189		0.197
E	3.80		4.00	0.15		0.157
e		1.27			0.050	
H	5.80		6.20	0.228		0.244
h	0.25		0.50	0.010		0.020
L	0.40		1.27	0.016		0.050
k	0° (min.), 8° (max.)					
ddd			0.10			0.004

Note: (1) Dimensions D does not include mold flash, protrusions or gate burrs.  
Mold flash, protrusions or gate burrs shall not exceed 0.15mm (.006inch) in total (both side).

**OUTLINE AND MECHANICAL DATA**



**SO-8**

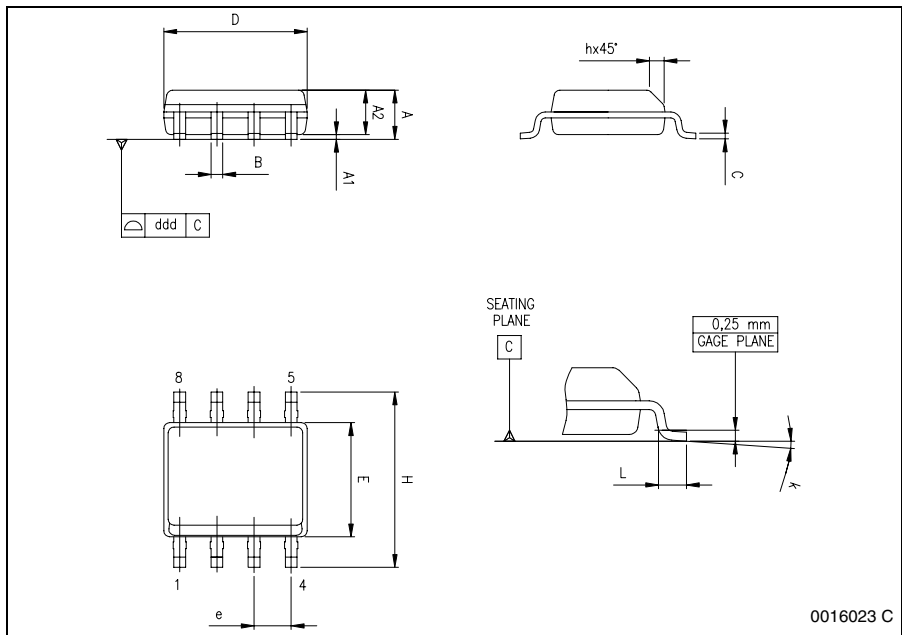

## 6 Revision History

**Table 9. Revision History**

<b>Date</b>	<b>Revision</b>	<b>Description of Changes</b>
January 2004	5	First Issue
June 2004	6	Modified the Style-look in compliance with the "Corporate Technical Publications Design Guide". Changed input of the power amplifier connected to Multiplier (Fig. 2).
May 2005	7	Modified Table 2: Absolute Maximim Ratings.
November 2005	8	Added in Section 5 the ECOPACK® certificate of conformity.

Information furnished is believed to be accurate and reliable. However, STMicroelectronics assumes no responsibility for the consequences of use of such information nor for any infringement of patents or other rights of third parties which may result from its use. No license is granted by implication or otherwise under any patent or patent rights of STMicroelectronics. Specifications mentioned in this publication are subject to change without notice. This publication supersedes and replaces all information previously supplied. STMicroelectronics products are not authorized for use as critical components in life support devices or systems without express written approval of STMicroelectronics.

The ST logo is a registered trademark of STMicroelectronics.  
All other names are the property of their respective owners

© 2005 STMicroelectronics - All rights reserved

STMicroelectronics group of companies

Australia - Belgium - Brazil - Canada - China - Czech Republic - Finland - France - Germany - Hong Kong - India - Israel - Italy - Japan -  
Malaysia - Malta - Morocco - Singapore - Spain - Sweden - Switzerland - United Kingdom - United States of America

[www.st.com](http://www.st.com)





Поставка электронных компонентов

**Юридический адрес организации:**  
198099, г. Санкт-Петербург, ул. Калинина, дом 2, кор. 4, лит А.  
**Фактический адрес организации:**  
198099, г. Санкт-Петербург, ул. Калинина, дом 2, кор. 4, лит А.  
ИНН 780277764  
КПП 780501001  
Р/С 40702810422510004035 ФАКБ "АБСОЛЮТ БАНК" (ЗАО) в Санкт-Петербурге К/С 30101810900000000703  
БИК 044030703  
**Телефон:** 8 (812) 309-44-11 (многоканальный)  
**Факс:** 8 (812) 309-44-11  
**Электронная почта:** [sales@timechips.ru](mailto:sales@timechips.ru)  
**Сайт:** [timechips.ru](http://timechips.ru)

## Информационное письмо

Компания «ТаймЧипс» - одна из наиболее динамично развивающихся компаний в сфере поставок электронных компонентов. Мы поставляем широкую номенклатуру электронных компонентов отечественных и импортных производителей, как напрямую, так и с крупных мировых складов, позволяющих охватить выборочную номенклатуру более 300 брендов, а также специализируемся на поставках дисплеев и является официальным дистрибьютором компании Shenzhen Startek Electronic Technology Co, на территории Российской Федерации.

Наличие собственной логистики позволяет в кратчайшие сроки доставлять товар нашим клиентам. В нашей компании имеется Конструкторский отдел, где наши специалисты проводят технические консультации клиентов, квалифицированную поддержку и помощь российским разработчикам. Осуществляем Поставки импортной продукции под контролем ВП МО РФ, на предприятия Оборонно-промышленного комплекса России. Система менеджмента качества компании соответствует требованиям ГОСТ ISO 9001-2011.

Благодаря нацеленности на результат, мы уверенно занимаем новые позиции на рынке, заинтересовывая Клиента не только актуальными ценами и гибким подходом, но и постоянным вниманием.

**Миссия** – обеспечение долгосрочного и взаимовыгодного партнерства с клиентами.

**Наша цель** – Обеспечение клиентам самого широкого ассортимента электронных компонентов и бесперебойности поставок.

**Мы - это развитие! Мы задаем темп! Мы разные, но вместе! Мы работаем для вас!**

Так же имеем прямые поставки от производителей:

TAI-SAW Пав-компоненты ([www.taisaw.com](http://www.taisaw.com))

TRANSCOM СВЧ-компоненты ([www.transcominc.com.tw](http://www.transcominc.com.tw))

Mini Circuits ВЧ-СВЧ-компоненты ([minicircuits.com](http://minicircuits.com))

SAMTEC- разъемы ([www.samtec.com](http://www.samtec.com))

4Star Разъемы РЧ (Даташиты по продукции 4Star, которые Вы сможете загрузить по этой ссылке: <https://yadi.sk/i/tPjnmGGrpmbYj>)

ULNION Преобразователи напряжения ([converterdc.com/](http://converterdc.com/))

**Отличные рекомендации на рынке, уверенность в качестве поставляемой продукции делают нас надежными партнерами для наших клиентов.**

**«ТаймЧипс» - это:**

- Гарантия качества поставляемой продукции;
- Широкий ассортимент;
- Минимальные сроки поставок;
- Техническая поддержка;
- Подбор комплектации;
- Индивидуальный подход;
- Гибкие цены.

**Модули, микросхемы, пассивные компоненты, Xilinx (XC), Altera (EP,EPF, EPM) и силовая электроника** – это наши ведущие позиции, на поставку которых мы гарантированно дадим Вам самые выгодные предложения!

**В структуру компании так же входит конструкторский отдел, который помогает разработчикам и конструкторам в решении следующих задач:**

- Оценка стоимости проекта по компонентам;
- Подбор оптимального решения при выборе компонента;
- Подбор аналогов;
- Техническая поддержка;
- Консультации у производителей;
- Поставка прототипов;

*С Уважением, Чернов Павел.*

*Руководитель отдела продаж ООО "ТАЙМЧИПС"*

*Официальный дистрибьютор Shenzhen Startek Electronic Technology Co.,Ltd в России (USB Display Modules , LED Displays, Serial Modules).*

<http://www.timechips.ru/>

<http://lcd-timechips.ru/>

**Телефон: +7 (812) 309-44-11 доб. 141**

**Факс: +7 (812) 309-44-11 доб. 152**

**Моб. Тел. +7 (905) 232-40-65**

**Skype: time.chips5**

**Электронная почта: [manager1@timechips.ru](mailto:manager1@timechips.ru)**

---