

RF Power LDMOS Transistors

High Ruggedness N-Channel Enhancement-Mode Lateral MOSFETs

These high ruggedness devices are designed for use in high VSWR industrial (including laser and plasma exciters), broadcast (analog and digital), aerospace and radio/land mobile applications. They are unmatched input and output designs allowing wide frequency range utilization, between 1.8 and 600 MHz.

- Typical Performance: $V_{DD} = 50$ Volts, $I_{DQ} = 100$ mA

| Signal Type | P_{out} (W) | f (MHz) | G_{ps} (dB) | η_D (%) |
|---------------------------------------|---------------|---------|---------------|--------------|
| Pulse (100 μ sec, 20% Duty Cycle) | 1250 Peak | 230 | 24.0 | 74.0 |
| CW | 1250 CW | 230 | 22.9 | 74.6 |

Application Circuits (1) — Typical Performance

| Frequency (MHz) | Signal Type | P_{out} (W) | G_{ps} (dB) | η_D (%) |
|-----------------|---------------------------------------|---------------|---------------|--------------|
| 27 | CW | 1300 | 27 | 81 |
| 40 | CW | 1300 | 26 | 85 |
| 81.36 | CW | 1250 | 27 | 84 |
| 87.5-108 | CW | 1100 | 24 | 80 |
| 144-148 | CW | 1250 | 26 | 78 |
| 170-230 | DVB-T | 225 | 25 | 30 |
| 352 | Pulse (200 μ sec, 20% Duty Cycle) | 1250 | 21.5 | 66 |
| 352 | CW | 1150 | 20.5 | 68 |
| 500 | CW | 1000 | 18 | 58 |

1. Contact your local Freescale sales office for additional information on specific circuit designs.

Load Mismatch/Ruggedness

| Frequency (MHz) | Signal Type | VSWR | P_{out} (W) | Test Voltage | Result |
|-----------------|---------------------------------------|----------------------------|----------------------------|--------------|-----------------------|
| 230 | Pulse (100 μ sec, 20% Duty Cycle) | > 65:1 at all Phase Angles | 1500 Peak (3 dB Overdrive) | 50 | No Device Degradation |

Features

- Unmatched Input and Output Allowing Wide Frequency Range Utilization
- Device can be used Single-Ended or in a Push-Pull Configuration
- Qualified Up to a Maximum of 50 V_{DD} Operation
- Characterized from 30 V to 50 V for Extended Power Range
- Suitable for Linear Application with Appropriate Biasing
- Integrated ESD Protection with Greater Negative Gate-Source Voltage Range for Improved Class C Operation
- Characterized with Series Equivalent Large-Signal Impedance Parameters
- In Tape and Reel. R6 Suffix = 150 Units, 56 mm Tape Width, 13-inch Reel. R5 Suffix = 50 Units, 56 mm Tape Width, 13-inch Reel.

MRFE6VP61K25HR6
MRFE6VP61K25HR5
MRFE6VP61K25HSR5
MRFE6VP61K25GSR5

1.8-600 MHz, 1250 W CW, 50 V WIDEBAND RF POWER LDMOS TRANSISTORS

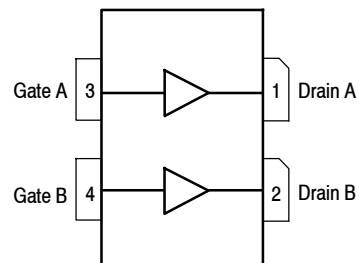
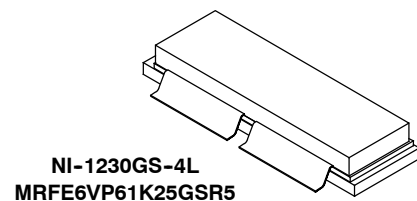
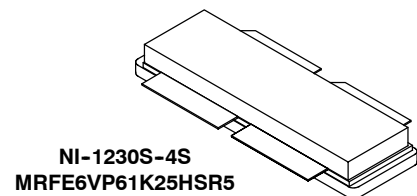
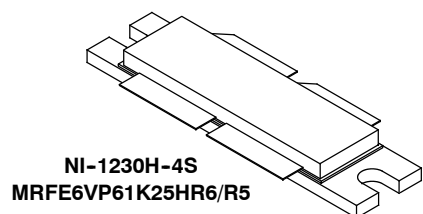

(Top View)

Note: The backside of the package is the source terminal for the transistors.

Figure 1. Pin Connections

Table 1. Maximum Ratings

| Rating | Symbol | Value | Unit |
|--|-----------|--------------|-----------|
| Drain-Source Voltage | V_{DS} | -0.5, +133 | Vdc |
| Gate-Source Voltage | V_{GS} | -6.0, +10 | Vdc |
| Storage Temperature Range | T_{stg} | -65 to +150 | °C |
| Case Operating Temperature | T_C | 150 | °C |
| Operating Junction Temperature (1,2) | T_J | 225 | °C |
| Total Device Dissipation @ $T_C = 25^\circ\text{C}$ Derate above 25°C | P_D | 1333 6.67 | W W/°C |

Table 2. Thermal Characteristics

| Characteristic | Symbol | Value (2,3) | Unit |
|---|-----------------|-------------|------|
| Thermal Resistance, Junction to Case CW: Case Temperature 63°C, 1250 W CW, $I_{DQ} = 100\text{ mA}$, 230 MHz | $R_{\theta JC}$ | 0.15 | °C/W |
| Thermal Impedance, Junction to Case Pulse: Case Temperature 66°C, 1250 W Pulse, 100 μsec Pulse Width, 20% Duty Cycle, $I_{DQ} = 100\text{ mA}$, 230 MHz | $Z_{\theta JC}$ | 0.03 | °C/W |

Table 3. ESD Protection Characteristics

| Test Methodology | Class |
|---------------------------------------|-------------------|
| Human Body Model (per JESD22-A114) | 2, passes 3500 V |
| Machine Model (per EIA/JESD22-A115) | B, passes 250 V |
| Charge Device Model (per JESD22-C101) | IV, passes 4000 V |

Table 4. Electrical Characteristics ($T_A = 25^\circ\text{C}$ unless otherwise noted)

| Characteristic | Symbol | Min | Typ | Max | Unit |
|----------------|--------|-----|-----|-----|------|
|----------------|--------|-----|-----|-----|------|

Off Characteristics (4)

| | | | | | |
|--|---------------|-----|---|----|-----------------|
| Gate-Source Leakage Current ($V_{GS} = 5\text{ Vdc}$, $V_{DS} = 0\text{ Vdc}$) | I_{GSS} | — | — | 1 | μAdc |
| Drain-Source Breakdown Voltage ($V_{GS} = 0\text{ Vdc}$, $I_D = 100\text{ mA}$) | $V_{(BR)DSS}$ | 133 | — | — | Vdc |
| Zero Gate Voltage Drain Leakage Current ($V_{DS} = 50\text{ Vdc}$, $V_{GS} = 0\text{ Vdc}$) | I_{DSS} | — | — | 10 | μAdc |
| Zero Gate Voltage Drain Leakage Current ($V_{DS} = 100\text{ Vdc}$, $V_{GS} = 0\text{ Vdc}$) | I_{DSS} | — | — | 20 | μAdc |

On Characteristics

| | | | | | |
|---|--------------|-----|------|-----|-----|
| Gate Threshold Voltage (4) ($V_{DS} = 10\text{ Vdc}$, $I_D = 1776\ \mu\text{Adc}$) | $V_{GS(th)}$ | 1.7 | 2.2 | 2.7 | Vdc |
| Gate Quiescent Voltage ($V_{DD} = 50\text{ Vdc}$, $I_D = 100\text{ mA}$, Measured in Functional Test) | $V_{GS(Q)}$ | 1.9 | 2.2 | 2.9 | Vdc |
| Drain-Source On-Voltage (4) ($V_{GS} = 10\text{ Vdc}$, $I_D = 2\text{ Adc}$) | $V_{DS(on)}$ | — | 0.15 | — | Vdc |
| Forward Transconductance ($V_{DS} = 10\text{ Vdc}$, $I_D = 30\text{ Adc}$) | g_{fs} | — | 28.0 | — | S |

Dynamic Characteristics (4)

| | | | | | |
|---|-----------|---|-----|---|----|
| Reverse Transfer Capacitance ($V_{DS} = 50\text{ Vdc} \pm 30\text{ mV(rms)ac}$ @ 1 MHz, $V_{GS} = 0\text{ Vdc}$) | C_{rss} | — | 2.8 | — | pF |
| Output Capacitance ($V_{DS} = 50\text{ Vdc} \pm 30\text{ mV(rms)ac}$ @ 1 MHz, $V_{GS} = 0\text{ Vdc}$) | C_{oss} | — | 185 | — | pF |
| Input Capacitance ($V_{DS} = 50\text{ Vdc}$, $V_{GS} = 0\text{ Vdc} \pm 30\text{ mV(rms)ac}$ @ 1 MHz) | C_{iss} | — | 562 | — | pF |

1. Continuous use at maximum temperature will affect MTTF.
2. MTTF calculator available at <http://www.freescale.com/rf>. Select Software & Tools/Development Tools/Calculators to access MTTF calculators by product.
3. Refer to AN1955, *Thermal Measurement Methodology of RF Power Amplifiers*. Go to <http://www.freescale.com/rf>. Select Documentation/Application Notes - AN1955.
4. Each side of device measured separately.

(continued)

MRFE6VP61K25HR6 MRFE6VP61K25HR5 MRFE6VP61K25HSR5 MRFE6VP61K25GSR5

Table 4. Electrical Characteristics ($T_A = 25^\circ\text{C}$ unless otherwise noted) (continued)

| Characteristic | Symbol | Min | Typ | Max | Unit |
|---|----------|------|------|------|------|
| Functional Tests ⁽¹⁾ (In Freescale Test Fixture, 50 ohm system) $V_{DD} = 50\text{ Vdc}$, $I_{DQ} = 100\text{ mA}$, $P_{out} = 1250\text{ W Peak}$ (250 W Avg.), $f = 230\text{ MHz}$, 100 μsec Pulse Width, 20% Duty Cycle | | | | | |
| Power Gain | G_{ps} | 23.0 | 24.0 | 26.0 | dB |
| Drain Efficiency | η_D | 72.5 | 74.0 | — | % |
| Input Return Loss | IRL | — | -14 | -10 | dB |

Table 5. Load Mismatch/Ruggedness (In Freescale Test Fixture, 50 ohm system) $I_{DQ} = 100\text{ mA}$

| Frequency (MHz) | Signal Type | VSWR | P_{out} (W) | Test Voltage, V_{DD} | Result |
|-----------------|---|-------------------------------|-------------------------------|------------------------|-----------------------|
| 230 | Pulse (100 μsec , 20% Duty Cycle) | > 65:1 at all Phase Angles | 1500 Peak (3 dB Overdrive) | 50 | No Device Degradation |

1. Measurements made with device in straight lead configuration before any lead forming operation is applied. Lead forming is used for gull wing (GS) parts.

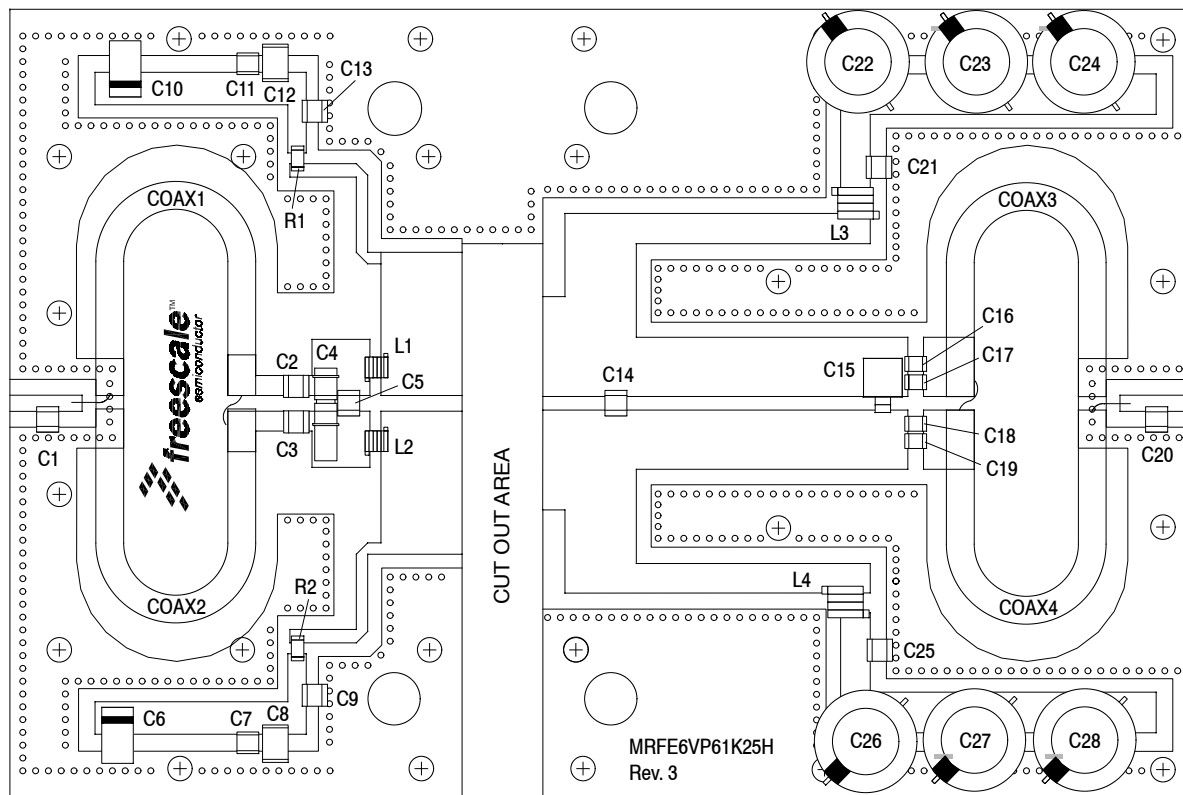

Figure 2. MRFE6VP61K25HR6(HSR6) 230 MHz Production Test Circuit Component Layout — Pulse

Table 6. MRFE6VP61K25HR6(HSR6) 230 MHz Production Test Circuit Component Designations and Values — Pulse

| Part | Description | Part Number | Manufacturer |
|------------------------------|---|----------------------|--------------|
| C1 | 20 pF Chip Capacitor | ATC100B200JT500XT | ATC |
| C2, C3, C5 | 27 pF Chip Capacitors | ATC100B270JT500XT | ATC |
| C4 | 0.8–8.0 pF Variable Capacitor, Gigatrim | 27291SL | Johanson |
| C6, C10 | 22 μ F, 35 V Tantalum Capacitors | T491X226K035AT | Kemet |
| C7, C11 | 0.1 μ F Chip Capacitors | CDR33BX104AKYS | AVX |
| C8, C12 | 220 nF Chip Capacitors | C1812C224K5RACTU | Kemet |
| C9, C13, C21, C25 | 1000 pF Chip Capacitors | ATC100B102JT50XT | ATC |
| C14 | 43 pF Chip Capacitor | ATC100B430JT500XT | ATC |
| C15 | 75 pF Metal Mica | MIN02-002EC750J-F | CDE |
| C16, C17, C18, C19 | 240 pF Chip Capacitors | ATC100B241JT200XT | ATC |
| C20 | 6.2 pF Chip Capacitor | ATC100B6R2BT500XT | ATC |
| C22, C23, C24, C26, C27, C28 | 470 μ F, 63 V Electrolytic Capacitors | MCGPR63V477M13X26-RH | Multicomp |
| Coax1, 2, 3, 4 | 25 Ω Semi Rigid Coax, 2.2" Shield Length | UT-141C-25 | Micro-Coax |
| L1, L2 | 5 nH Inductors | A02TKLC | Coilcraft |
| L3, L4 | 6.6 nH Inductors | GA3093-ALC | Coilcraft |
| R1, R2 | 10 Ω Chip Resistors | CRCW120610R0JNEA | Vishay |
| PCB | 0.030", $\epsilon_r = 2.55$ | AD255A | Arlon |

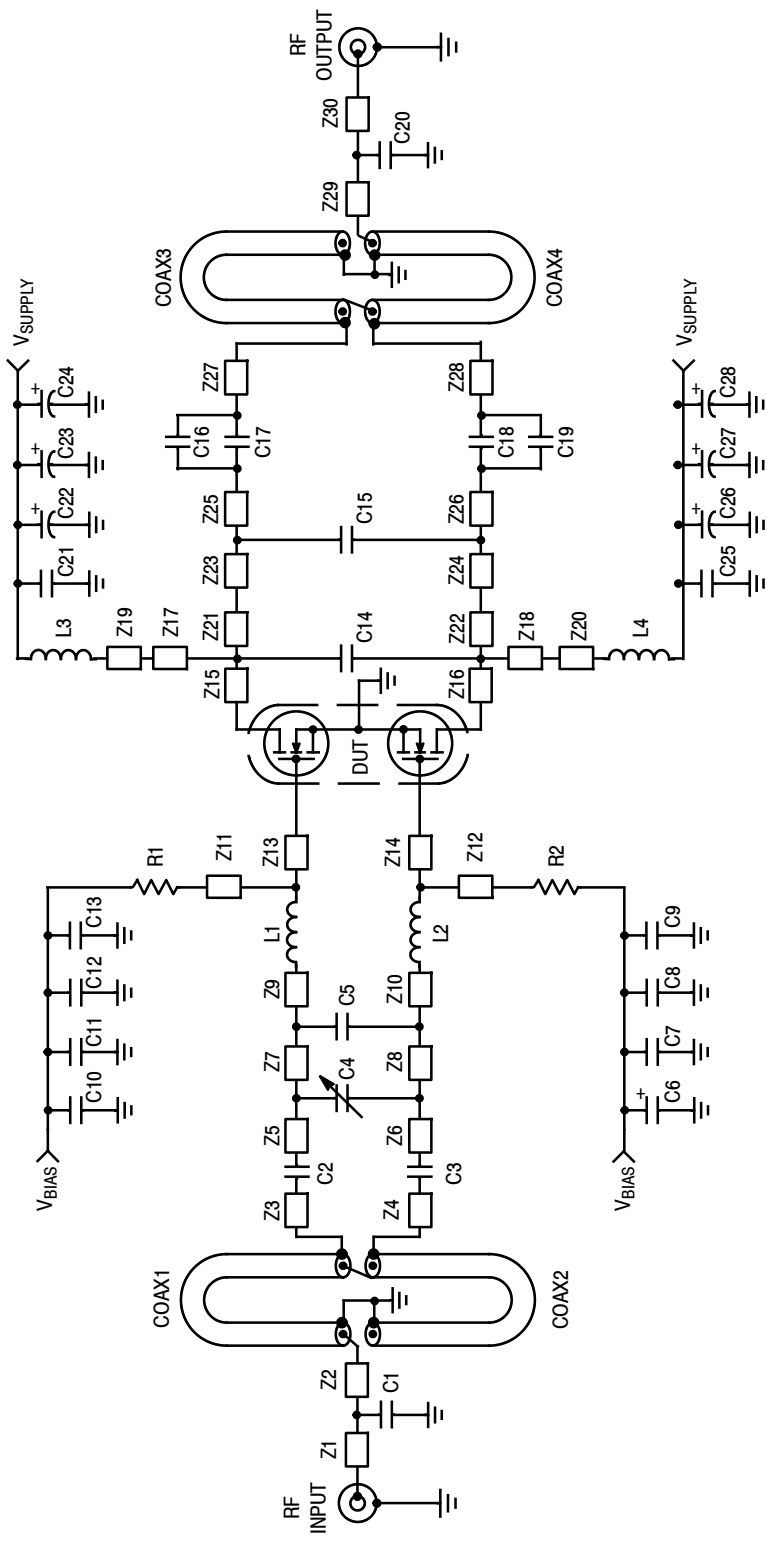

Figure 3. MRFE6VP61K25HR6(HSR6) 230 MHz Production Test Circuit Schematic — Pulse

Table 7. MRFE6VP61K25HR6(HSR6) 230 MHz Production Test Circuit Microstrips — Pulse

| Microstrip | Description | Microstrip | Description |
|------------|----------------------------|------------|----------------------------|
| Z1 | 0.192" x 0.082" Microstrip | Z11* | 0.872" x 0.058" Microstrip |
| Z2 | 0.175" x 0.082" Microstrip | Z13, Z14 | 0.412" x 0.726" Microstrip |
| Z3, Z4 | 0.170" x 0.100" Microstrip | Z15, Z16 | 0.371" x 0.507" Microstrip |
| Z5, Z6 | 0.116" x 0.285" Microstrip | Z17*, Z18* | 0.466" x 0.363" Microstrip |
| Z7, Z8 | 0.116" x 0.285" Microstrip | Z19*, Z20* | 0.187" x 0.154" Microstrip |
| Z9, Z10 | 0.108" x 0.285" Microstrip | Z21, Z22 | 0.104" x 0.507" Microstrip |
| Z23, Z24 | 1.251" x 0.300" Microstrip | Z25, Z26 | 0.127" x 0.300" Microstrip |
| Z27, Z28 | 0.116" x 0.300" Microstrip | Z27, Z28 | 0.116" x 0.300" Microstrip |
| Z29 | 0.186" x 0.082" Microstrip | Z29 | 0.186" x 0.082" Microstrip |
| Z30 | 0.179" x 0.082" Microstrip | Z30 | 0.179" x 0.082" Microstrip |

* Line length includes microstrip bends

TYPICAL CHARACTERISTICS

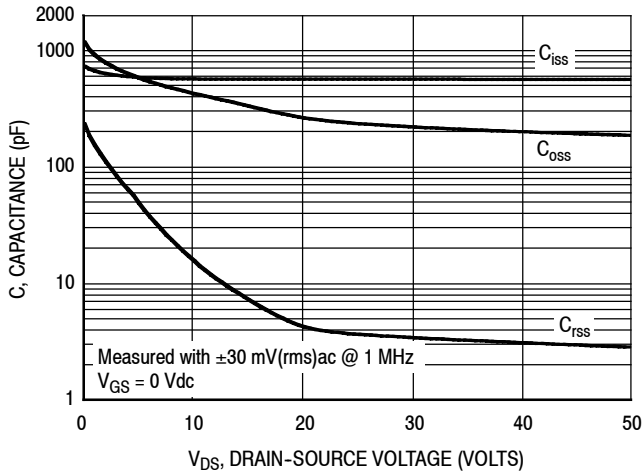

Note: Each side of device measured separately.

Figure 4. Capacitance versus Drain-Source Voltage

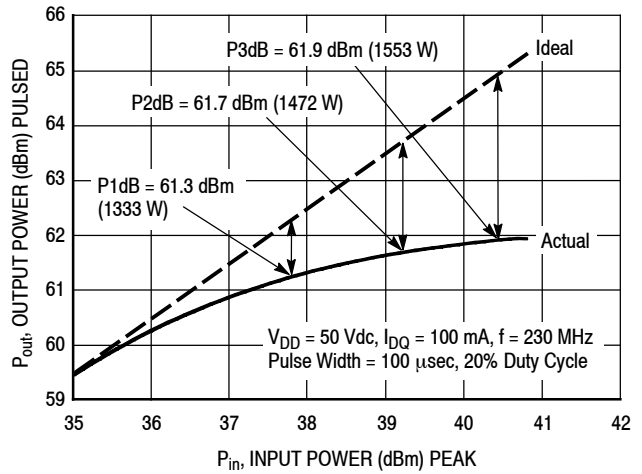

Figure 5. Output Power versus Input Power

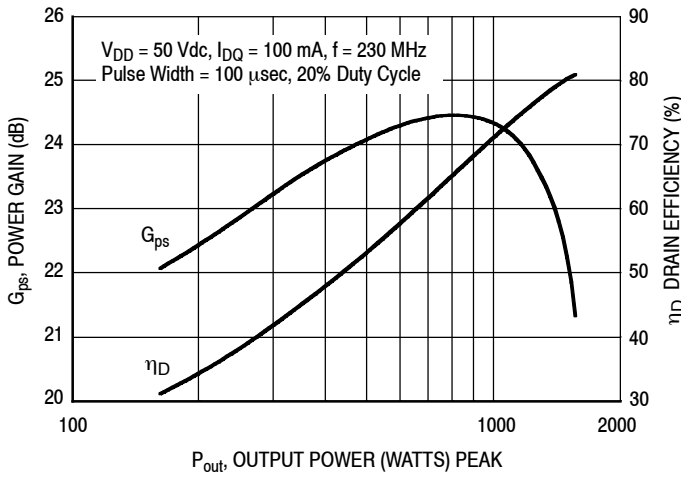

Figure 6. Power Gain and Drain Efficiency versus Output Power

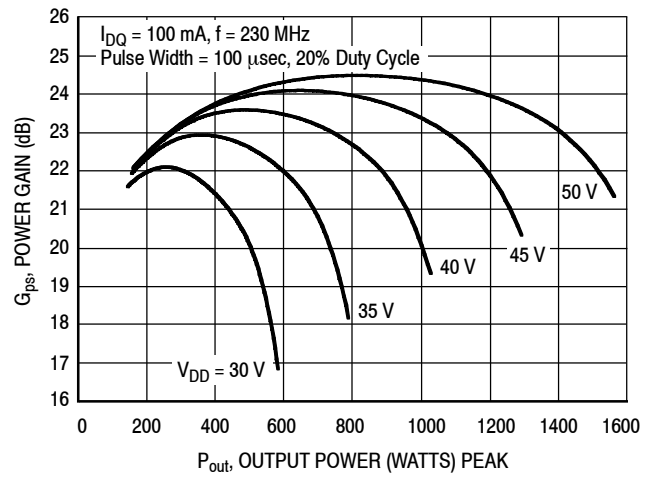

Figure 7. Power Gain versus Output Power

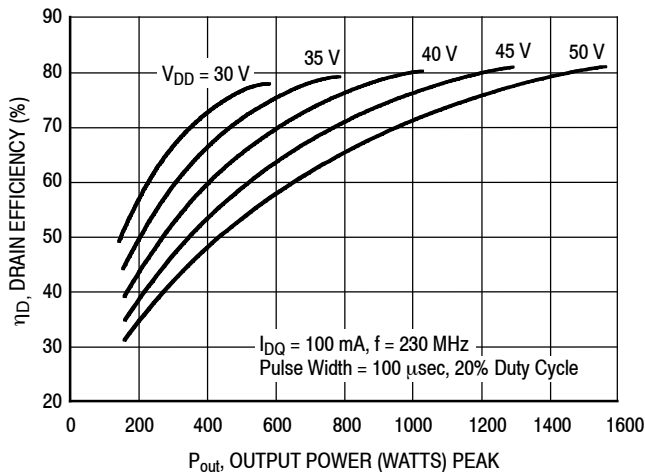

Figure 8. Drain Efficiency versus Output Power

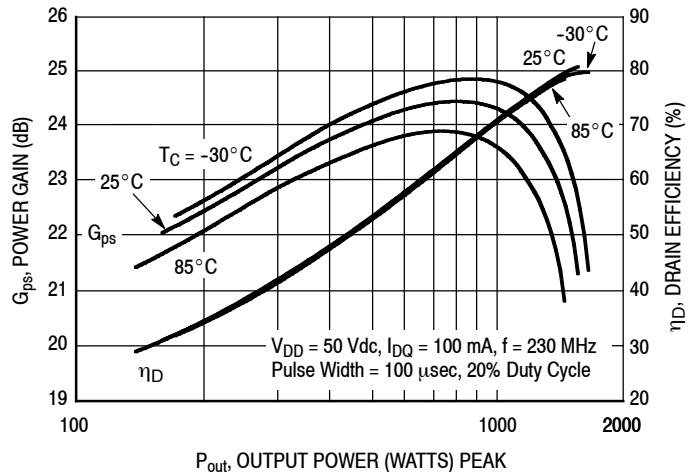
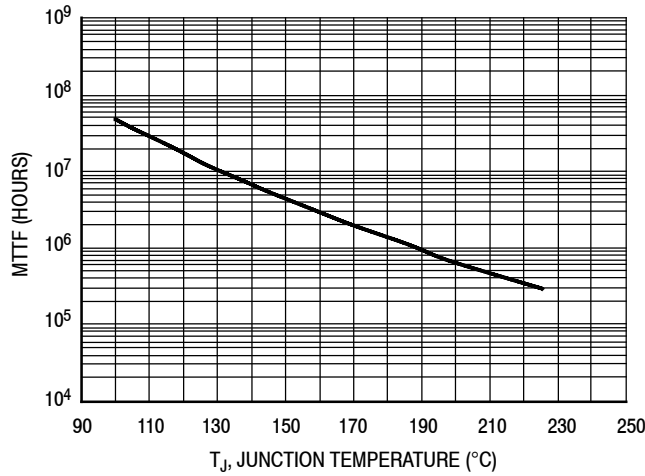

Figure 9. Power Gain and Drain Efficiency versus Output Power

TYPICAL CHARACTERISTICS



This above graph displays calculated MTTF in hours when the device is operated at $V_{DD} = 50$ Vdc, $P_{out} = 1250$ W CW, and $\eta_D = 74.6\%$.

MTTF calculator available at <http://www.freescale.com/rf>. Select Software & Tools/Development Tools/Calculators to access MTTF calculators by product.

Figure 10. MTTF versus Junction Temperature — CW

$V_{DD} = 50$ Vdc, $I_{DQ} = 100$ mA, $P_{out} = 1250$ W Peak

| f MHz | Z _{source} Ω | Z _{load} Ω |
|----------|--------------------------|------------------------|
| 230 | 1.29 + j3.54 | 2.12 + j2.68 |

Z_{source} = Test circuit impedance as measured from gate to gate, balanced configuration.

Z_{load} = Test circuit impedance as measured from drain to drain, balanced configuration.

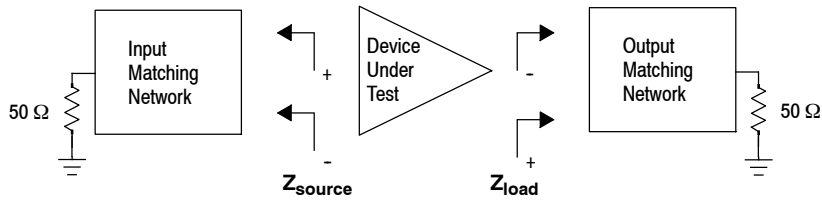

Figure 11. Series Equivalent Test Circuit Source and Load Impedance — 230 MHz Pulse

$V_{DD} = 50 \text{ Vdc}$, $I_{DQ} = 100 \text{ mA}$

| f (MHz) | Z_{source} (Ω) | Z_{load} (Ω) |
|---------|----------------------------------|--------------------------------|
| 1.8 (1) | $34.4 + j192.0$ (1) | $5.00 - j4.00$ (1) |
| 27 | $12.5 + j7.00$ | $7.00 + j0.70$ |
| 40 | $5.75 + j5.06$ | $5.39 + j2.62$ |
| 81.36 | $4.04 + j5.93$ | $4.89 + j2.95$ |
| 88 | $2.20 + j6.70$ | $4.90 + j2.90$ |
| 98 | $2.30 + j6.90$ | $4.10 + j2.50$ |
| 108 | $2.30 + j7.00$ | $4.40 + j3.60$ |
| 144 | $1.60 + j5.00$ | $3.90 + j1.50$ |
| 175 | $1.33 + j3.90$ | $3.50 + j2.50$ |
| 230 | $1.29 + j3.54$ | $2.12 + j2.68$ |
| 352 | $0.98 + j1.45$ | $1.82 + j2.05$ |
| 500 | $0.29 + j1.47$ | $1.79 + j1.80$ |

1. Simulated data.

Z_{source} = Test circuit impedance as measured from gate to gate, balanced configuration.

Z_{load} = Test circuit impedance as measured from drain to drain, balanced configuration.

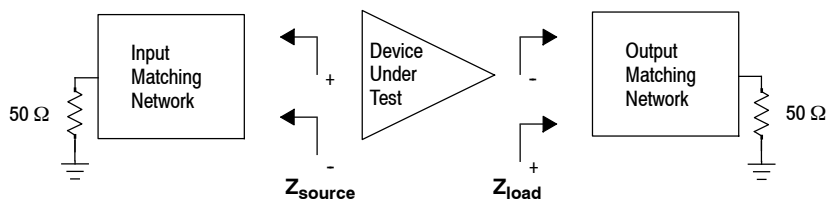

Figure 12. Source and Load Impedances Optimized for IRL, Power and Efficiency — Push-Pull

87.5-108 MHz FM BROADCAST REFERENCE CIRCUIT

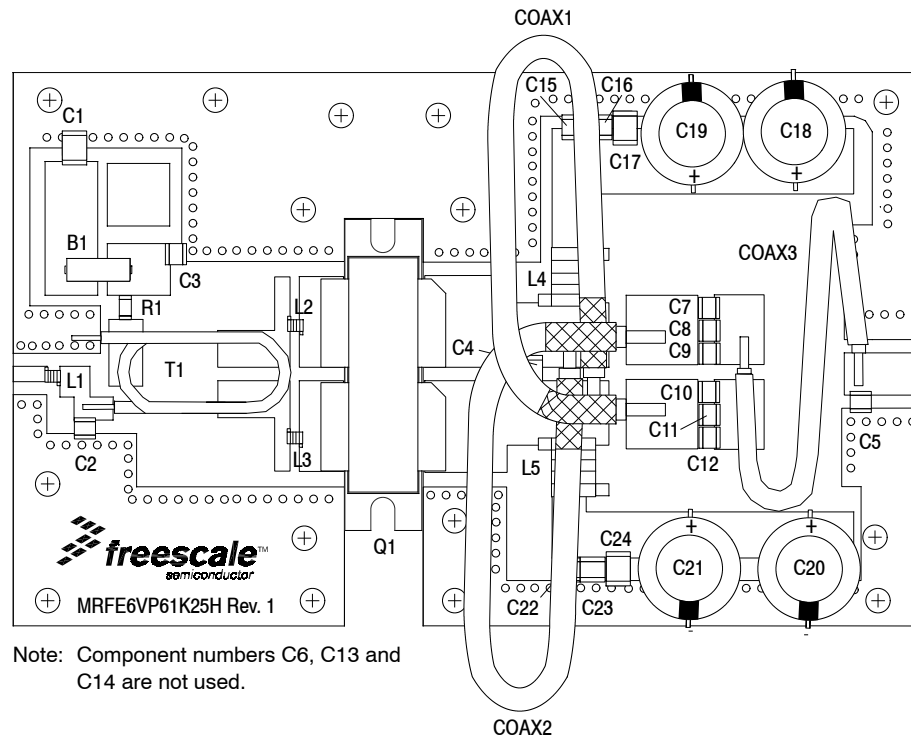

Figure 13. MRFE6VP61K25HR6(HSR6) 87.5-108 MHz FM Broadcast Reference Circuit Component Layout

Table 8. MRFE6VP61K25HR6(HSR6) 87.5-108 MHz FM Broadcast Reference Circuit Component Designations and Values

| Part | Description | Part Number | Manufacturer |
|-------------------------------|---|----------------------|------------------|
| B1 | Long Ferrite Bead | 2743021447 | Fair-Rite |
| C1 | 6.8 μ F, 50 V Chip Capacitor | C4532X7R1H685K | TDK |
| C2 | 27 pF Chip Capacitor | ATC100B270JT500XT | ATC |
| C3, C7, C8, C9, C10, C11, C12 | 1000 pF Chip Capacitors | ATC100B102JT50XT | ATC |
| C4 | 39 pF Mica Capacitor | MIN02-002DC390J-F | Cornell Dubilier |
| C5 | 3 pF Chip Capacitor | ATC100B3R0CT500XT | ATC |
| C15, C22 | 10K pF Chip Capacitors | ATC200B103KT50XT | ATC |
| C16, C23 | 1 μ F, 100 V Chip Capacitors | C3225JB2A105KT | TDK |
| C17, C24 | 10 μ F, 100 V Chip Capacitors | C5750X7S2A106MT | TDK |
| C18, C19, C20, C21 | 470 μ F, 63 V Electrolytic Capacitors | MCGPR63V477M13X26-RH | Multicomp |
| L1 | 39 nH Inductor | 1812SMS-39NJLC | Coilcraft |
| L2, L3 | 2.5 nH Inductors | A01TKLC | Coilcraft |
| L4, L5 | 7 Turn, #16 AWG, ID = 0.3" Inductors | Copper Wire | |
| Q1 | RF Power LDMOS Transistor | MRFE6VP61K25HR6 | Freescale |
| R1 | 11 Ω , 1/4 W Chip Resistor | CRCW120611R0FKEA | Vishay |
| T1 | Balun | TUI-9 | Comm Concepts |
| Coax1, Coax2 | Flex Cables (12 Ω), 5.9" | TC-12 | Comm Concepts |
| Coax3 | Coax Cable, Quickform 50 Ω , 8.7" | SUCOFORM 250-01 | Huber+Suhner |
| PCB | 0.030", $\epsilon_r = 3.5$ | TC-350 | Arlon |
| Heatsink | NI-1230 Copper Heatsink | C193X280T970 | Machine Shop |

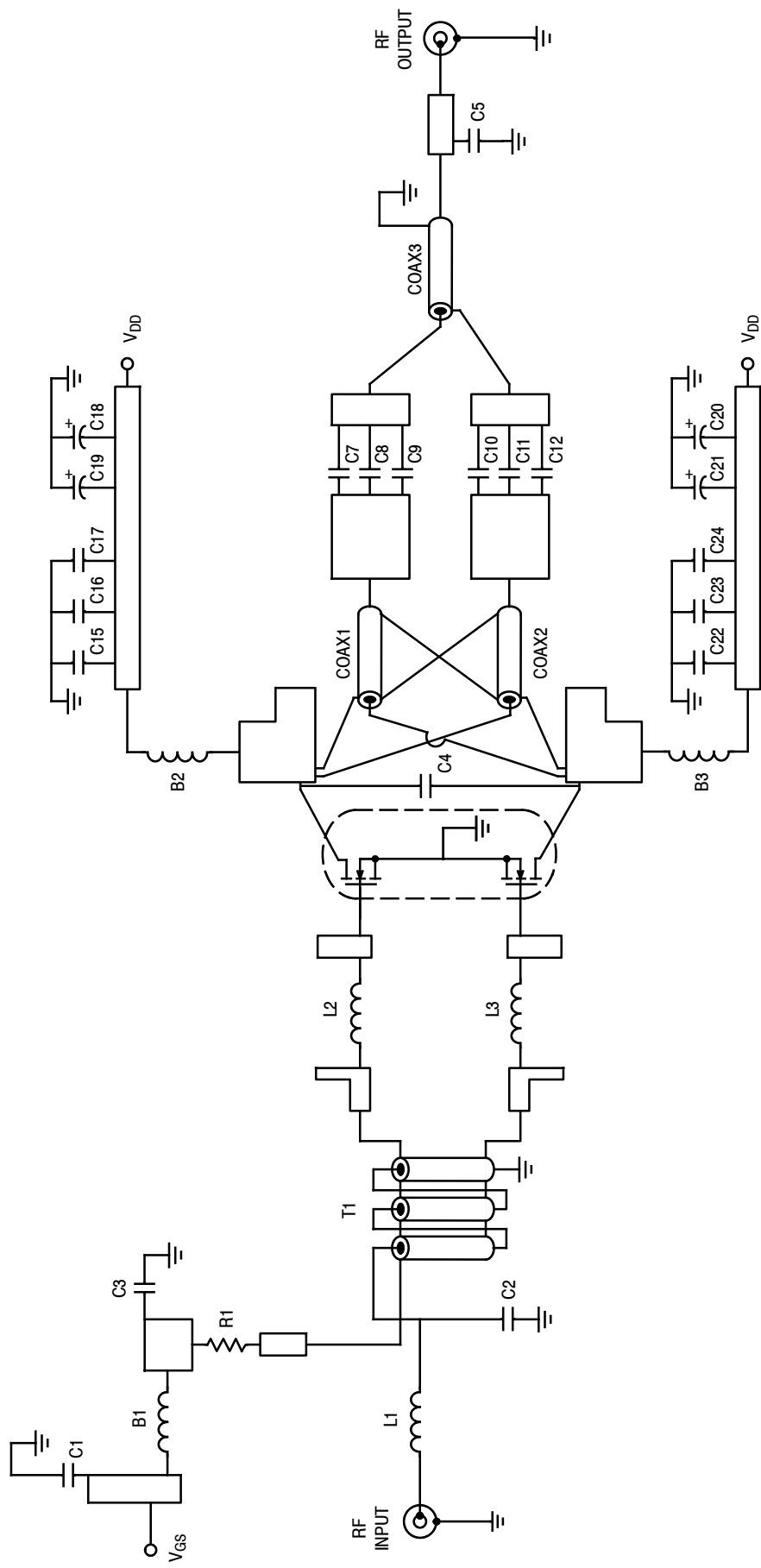

Figure 14. MRFE6VP61K25HR6(HSR6) 87.5-108 MHz FM Broadcast Reference Circuit Schematic

MRFE6VP61K25HR6 MRFE6VP61K25HR5 MRFE6VP61K25HSR5 MRFE6VP61K25GSR5

TYPICAL CHARACTERISTICS — 87.5-108 MHz FM BROADCAST REFERENCE CIRCUIT

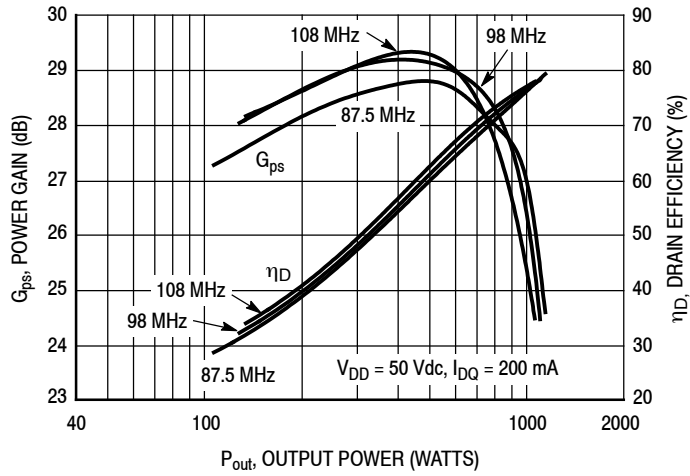

Figure 15. Power Gain and Drain Efficiency versus Output Power

$V_{DD} = 50 \text{ Vdc}$, $I_{DQ} = 200 \text{ mA}$, $P_{out} = 1100 \text{ W CW}$

| f MHz | $Z_{source} \Omega$ | $Z_{load} \Omega$ |
|-------|---------------------|-------------------|
| 87.5 | $2.20 + j6.70$ | $4.90 + j2.90$ |
| 98 | $2.30 + j6.90$ | $4.10 + j2.50$ |
| 108 | $2.30 + j7.00$ | $4.40 + j3.60$ |

Z_{source} = Test circuit impedance as measured from gate to gate, balanced configuration.

Z_{load} = Test circuit impedance as measured from drain to drain, balanced configuration.

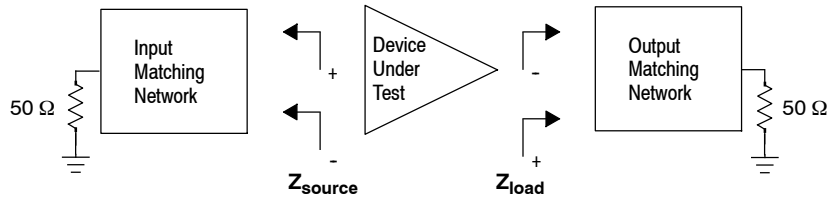
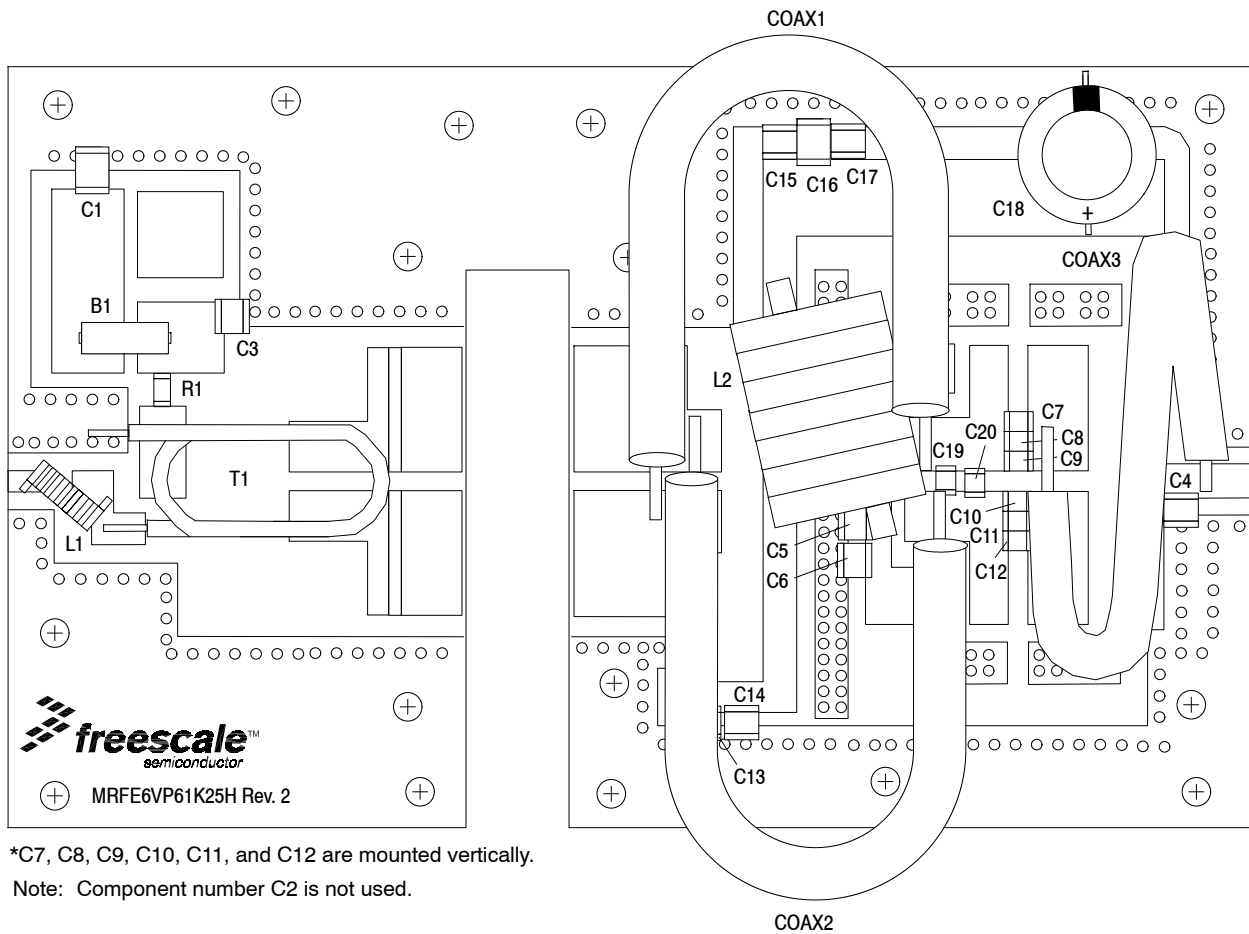

Figure 16. Series Equivalent 87.5-108 MHz FM Broadcast Reference Circuit Source and Load Impedance

144-148 MHz REFERENCE CIRCUIT



*C7, C8, C9, C10, C11, and C12 are mounted vertically.

Note: Component number C2 is not used.

Figure 17. MRFE6VP61K25HR6(HSR6) 144-148 MHz Reference Circuit Component Layout

Table 9. MRFE6VP61K25HR6(HSR6) 144-148 MHz Reference Circuit Component Designations and Values

| Part | Description | Part Number | Manufacturer |
|---|---|-----------------------|---------------|
| B1 | 95 Ω , 100 MHz Long Ferrite Bead | 2743021447 | Fair-Rite |
| C1 | 6.8 μ F, 50 V Chip Capacitor | C4532X7R1H685K | TDK |
| C3, C5, C7, C8, C9, C10, C11, C12, C13, C15 | 1000 pF Chip Capacitors | ATC100B102KT50XT | ATC |
| C4 | 5.6 pF Chip Capacitor | ATC100B5R6CT500XT | ATC |
| C6 | 470 pF Chip Capacitor | ATC100B471JT200XT | ATC |
| C14, C16 | 1 μ F, 100 V Chip Capacitors | C3225JB2A105KT | TDK |
| C17 | 2.2 μ F, 100 V Chip Capacitor | HMK432B7225KM-T | Taiyo Yuden |
| C18 | 470 μ F, 100 V Electrolytic Capacitor | MCGPR100V477M16X32-RH | Multicomp |
| C19, C20 | 15 pF Chip Capacitors | ATC100B150JT500XT | ATC |
| L1 | 43 nH Inductor | B10TJLC | Coilcraft |
| L2 | 7 Turn, #14 AWG, ID = 0.4" Inductor | Handwound | Freescale |
| R1 | 11 Ω , 1/4 W Chip Resistor | CRCW120611R0FKEA | Vishay |
| T1 | Balun | TUI-9 | Comm Concepts |
| Coax1, Coax2 | Flex Cables, 10.2 Ω , 4.7" | TC-12 | Comm Concepts |
| Coax3 | Coax Cable, 50 Ω , 6.7" | SUCOFORM250-01 | Huber+Suhner |
| PCB | 0.030", $\epsilon_r = 3.50$ | TC-350 | Arlon |

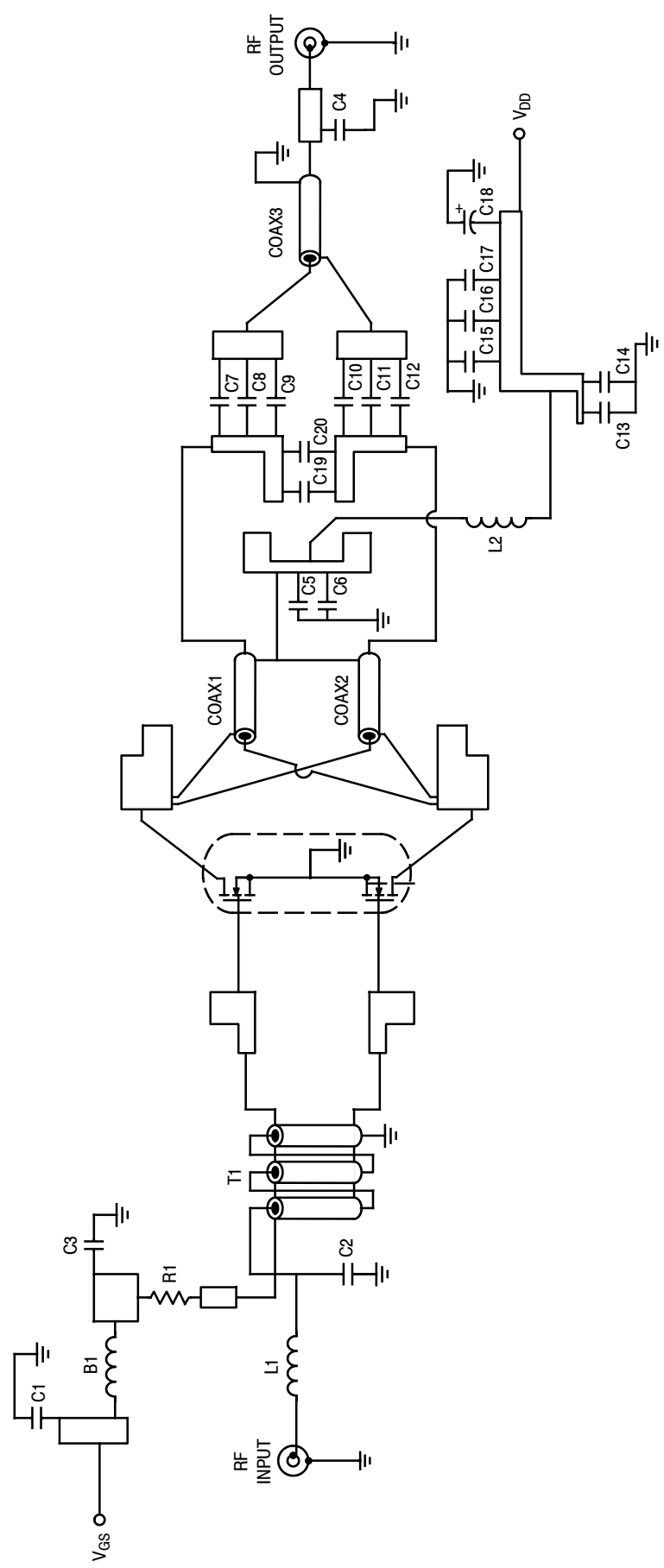

Figure 18. MRFE6VP61K25HR6(HSR6) 144-148 MHz Reference Circuit Schematic

MRFE6VP61K25HR6 MRFE6VP61K25HR5 MRFE6VP61K25HSR5 MRFE6VP61K25GSR5

TYPICAL CHARACTERISTICS — 144-148 MHz REFERENCE CIRCUIT

$V_{DD} = 50 \text{ Vdc}$, $I_{DQ} = 200 \text{ mA}$, $P_{out} = 1100 \text{ W CW}$

| f MHz | Z_{source} Ω | Z_{load} Ω |
|----------|--------------------------|------------------------|
| 144 | $1.6 + j5.0$ | $3.9 + j1.5$ |

Z_{source} = Test circuit impedance as measured from gate to gate, balanced configuration.

Z_{load} = Test circuit impedance as measured from drain to drain, balanced configuration.

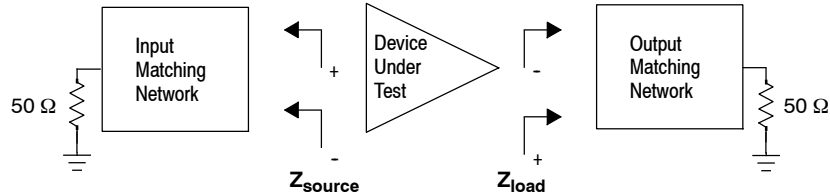

Figure 19. Series Equivalent 144-148 MHz Reference Circuit Source and Load Impedance

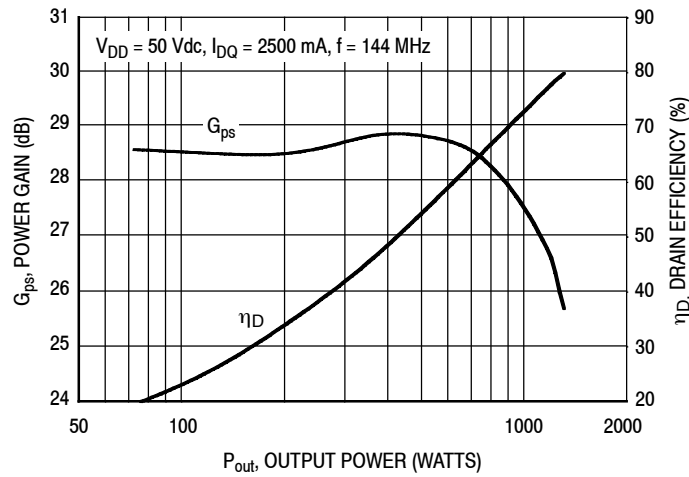

Figure 20. Power Gain and Drain Efficiency versus Output Power

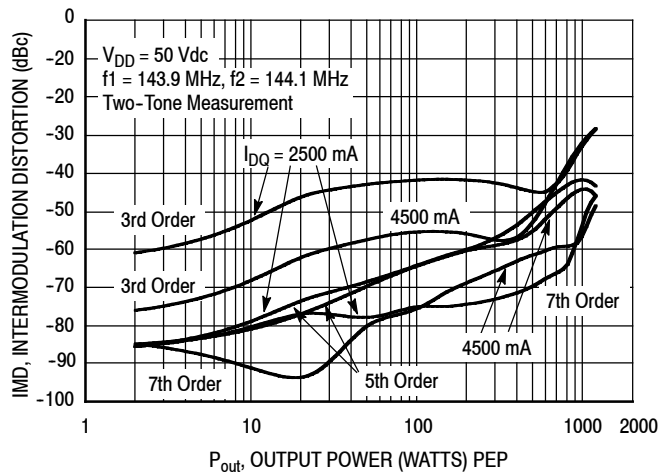
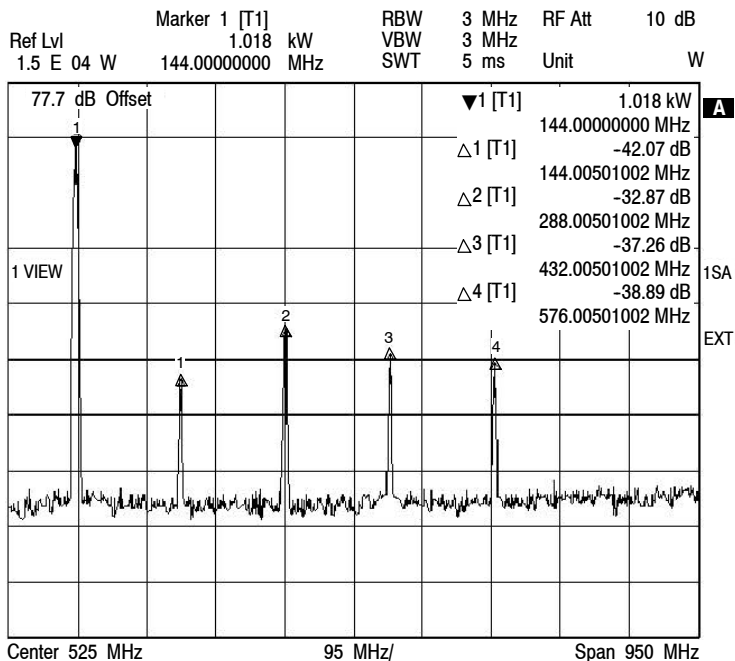

Figure 21. Intermodulation Distortion Products versus Output Power

HARMONIC MEASUREMENTS



144 MHz, 1 kW

| H2 | H3 | H4 | H5 |
|--------|--------|--------|--------|
| -42 dB | -33 dB | -37 dB | -39 dB |

Figure 22. 144 MHz Harmonics @ 1 kW

PACKAGE DIMENSIONS

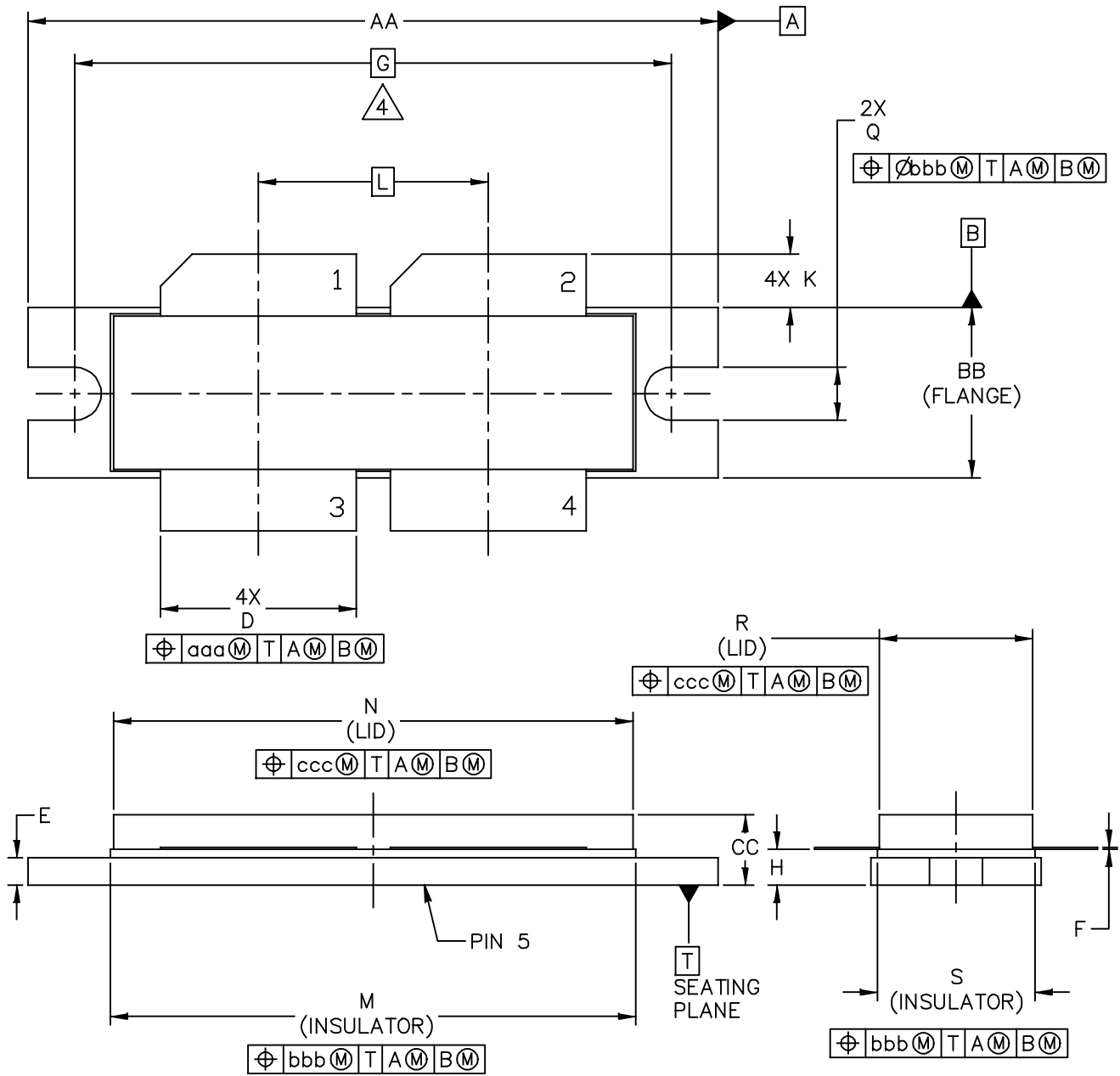

| | | |
|---|--------------------------|----------------------------|
| © FREESCALE SEMICONDUCTOR, INC. ALL RIGHTS RESERVED. | MECHANICAL OUTLINE | PRINT VERSION NOT TO SCALE |
| TITLE: NI-1230-4H | DOCUMENT NO: 98ASB16977C | REV: F |
| | STANDARD: NON-JEDEC | |
| | 28 FEB 2013 | |

NOTES:

1. INTERPRET DIMENSIONS AND TOLERANCES PER ASME Y14.5M-1994.
2. CONTROLLING DIMENSION: INCH
3. DIMENSION H IS MEASURED .030 INCH (0.762 MM) AWAY FROM PACKAGE BODY.
4. RECOMMENDED BOLT CENTER DIMENSION OF 1.52 INCH (38.61 MM) BASED ON M3 SCREW.

| DIM | INCH | | MILLIMETER | | DIM | INCH | | MILLIMETER | |
|-----|-----------|-------|------------|-------|-----|-------|-------|------------|-------|
| | MIN | MAX | MIN | MAX | | MIN | MAX | MIN | MAX |
| AA | 1.615 | 1.625 | 41.02 | 41.28 | N | 1.218 | 1.242 | 30.94 | 31.55 |
| BB | .395 | .405 | 10.03 | 10.29 | Q | .120 | .130 | 3.05 | 3.30 |
| CC | .170 | .190 | 4.32 | 4.83 | R | .355 | .365 | 9.02 | 9.27 |
| D | .455 | .465 | 11.56 | 11.81 | S | .365 | .375 | 9.27 | 9.53 |
| E | .062 | .066 | 1.57 | 1.68 | | | | | |
| F | .004 | .007 | 0.10 | 0.18 | | | | | |
| G | 1.400 BSC | | 35.56 BSC | | aaa | .013 | | 0.33 | |
| H | .082 | .090 | 2.08 | 2.29 | bbb | .010 | | 0.25 | |
| K | .117 | .137 | 2.97 | 3.48 | ccc | .020 | | 0.51 | |
| L | .540 BSC | | 13.72 BSC | | | | | | |
| M | 1.219 | 1.241 | 30.96 | 31.52 | | | | | |

| | | | | | |
|---|--|--------------------|--------------------------|----------------------------|--------|
| © FREESCALE SEMICONDUCTOR, INC. ALL RIGHTS RESERVED. | | MECHANICAL OUTLINE | | PRINT VERSION NOT TO SCALE | |
| TITLE: | | | DOCUMENT NO: 98ASB16977C | | REV: F |
| NI-1230-4H | | | STANDARD: NON-JEDEC | | |
| | | | 28 FEB 2013 | | |

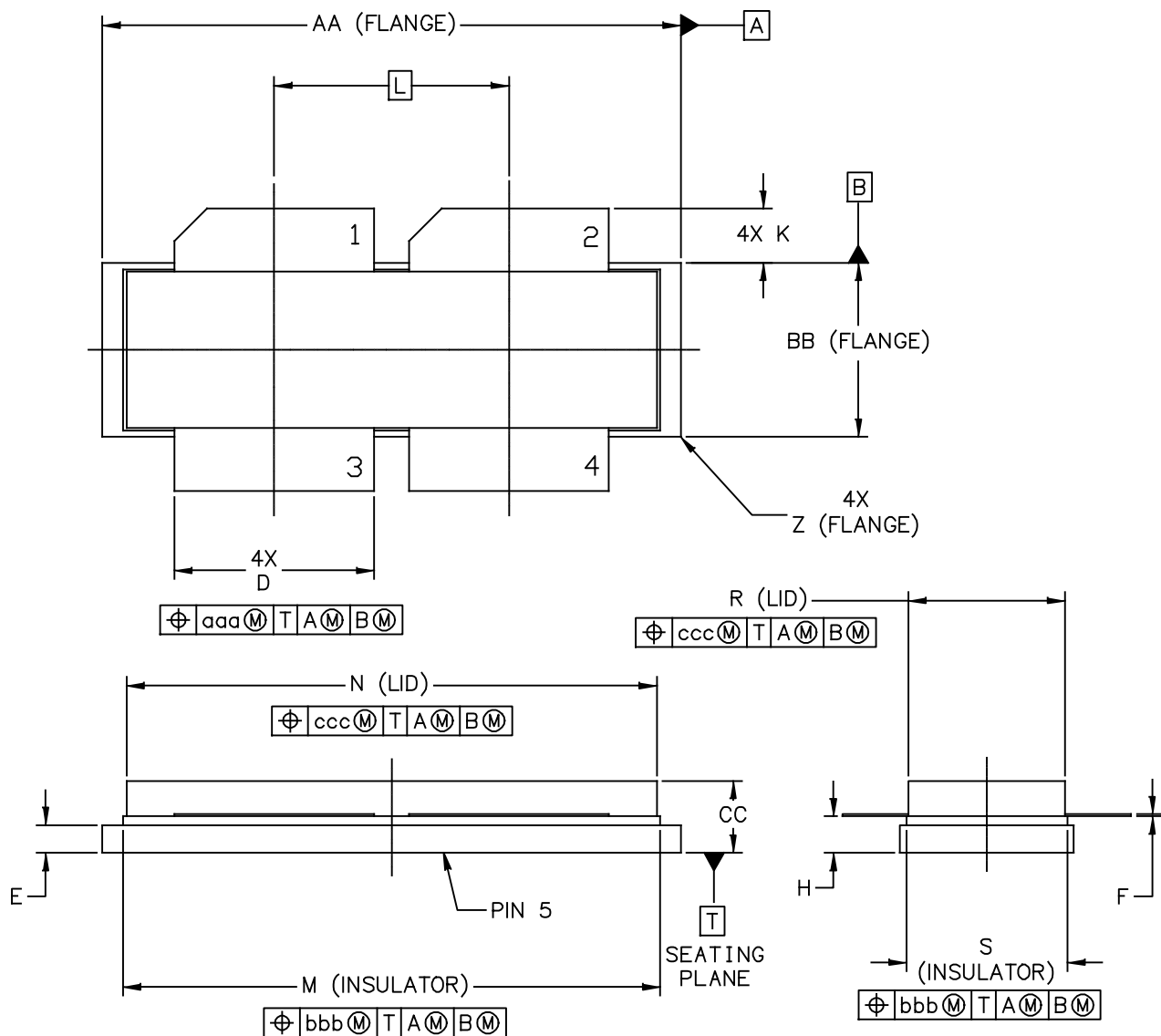

| | | |
|---|--------------------------|----------------------------|
| © FREESCALE SEMICONDUCTOR, INC. ALL RIGHTS RESERVED. | MECHANICAL OUTLINE | PRINT VERSION NOT TO SCALE |
| TITLE: NI-1230-4S | DOCUMENT NO: 98ARB18247C | REV: G |
| | STANDARD: NON-JEDEC | |
| | 01 MAR 2013 | |

NOTES:

1. INTERPRET DIMENSIONS AND TOLERANCES PER ASME Y14.5M–1994.
2. CONTROLLING DIMENSION: INCH
3. DIMENSION H IS MEASURED .030 INCH (0.762 MM) AWAY FROM PACKAGE BODY

| DIM | INCHES | | MILLIMETERS | | DIM | INCHES | | MILLIMETERS | |
|---|----------|-------|--------------------|-------|--------------------------|----------------------------|--------|-------------|-------|
| | MIN | MAX | MIN | MAX | | MIN | MAX | MIN | MAX |
| AA | 1.265 | 1.275 | 32.13 | 32.39 | R | .355 | .365 | 9.02 | 9.27 |
| BB | .395 | .405 | 10.03 | 10.29 | S | .365 | .375 | 9.27 | 9.53 |
| CC | .170 | .190 | 4.32 | 4.83 | Z | R.000 | R.040 | R0.00 | R1.02 |
| D | .455 | .465 | 11.56 | 11.81 | | | | | |
| E | .062 | .066 | 1.57 | 1.68 | aaa | .013 | | 0.33 | |
| F | .004 | .007 | 0.10 | 0.18 | bbb | .010 | | 0.25 | |
| H | .082 | .090 | 2.08 | 2.29 | ccc | .020 | | 0.51 | |
| K | .117 | .137 | 2.97 | 3.48 | | | | | |
| L | .540 BSC | | 13.72 BSC | | | | | | |
| M | 1.219 | 1.241 | 30.96 | 31.52 | | | | | |
| N | 1.218 | 1.242 | 30.94 | 31.55 | | | | | |
| © FREESCALE SEMICONDUCTOR, INC. ALL RIGHTS RESERVED. | | | MECHANICAL OUTLINE | | | PRINT VERSION NOT TO SCALE | | | |
| TITLE: | | | | | DOCUMENT NO: 98ARB18247C | | REV: G | | |
| NI-1230-4S | | | | | STANDARD: NON-JEDEC | | | | |
| | | | | | 01 MAR 2013 | | | | |

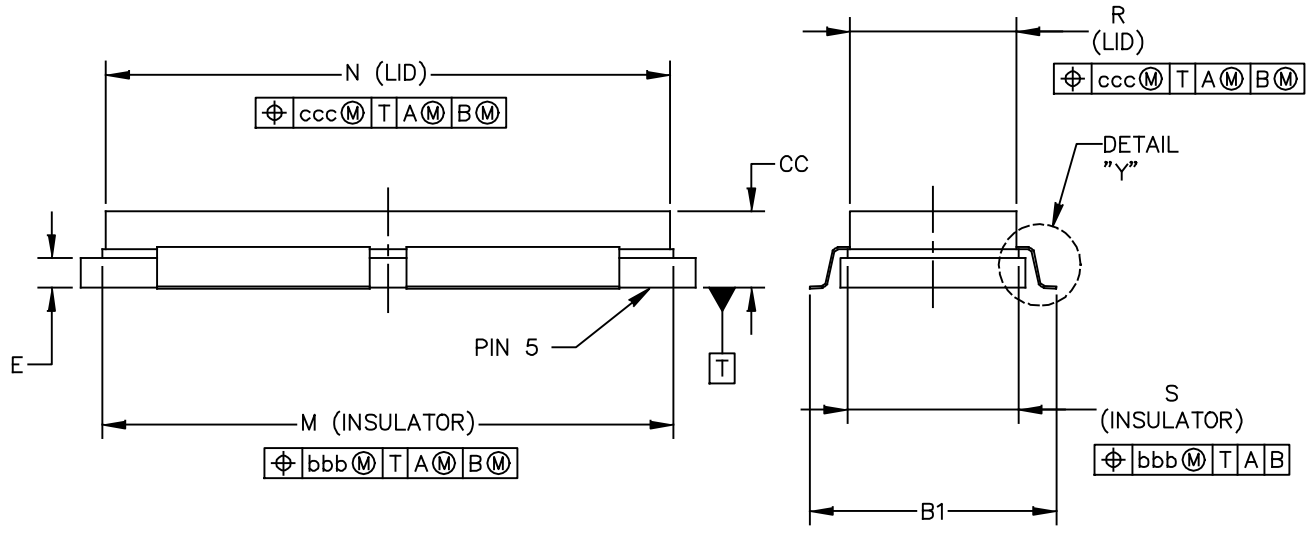
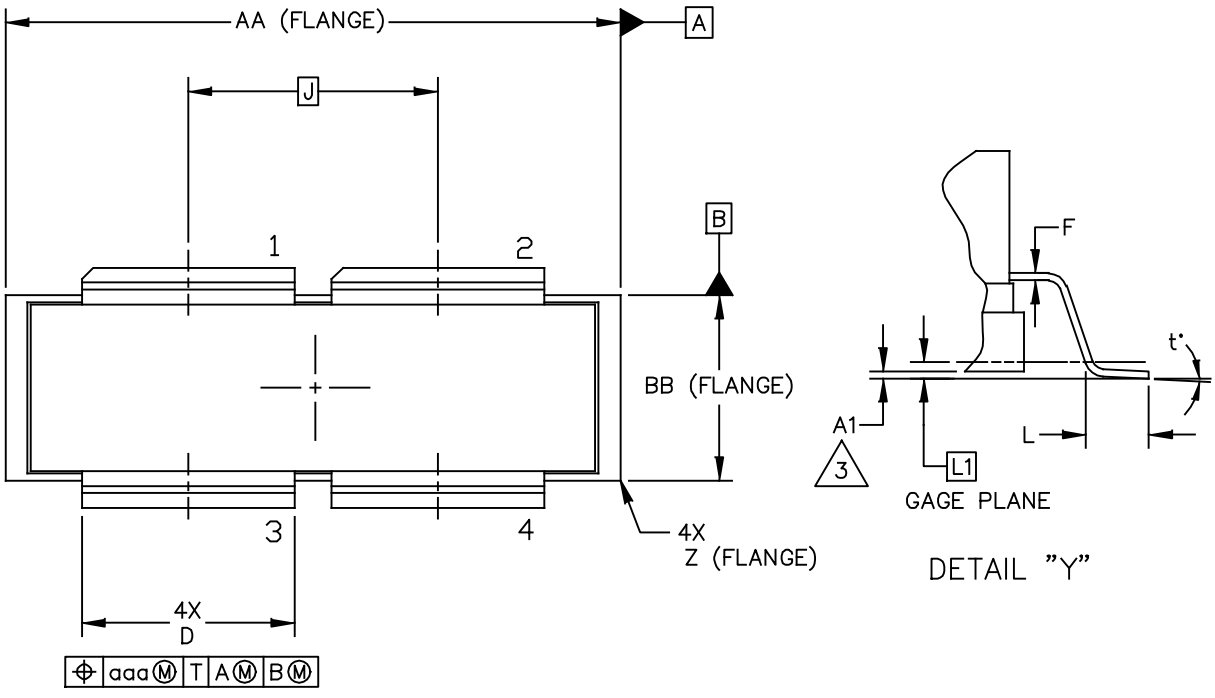

| | | |
|---|--------------------------|----------------------------|
| © FREESCALE SEMICONDUCTOR, INC. ALL RIGHTS RESERVED. | MECHANICAL OUTLINE | PRINT VERSION NOT TO SCALE |
| TITLE: NI-1230-4S GULL | DOCUMENT NO: 98ASA00459D | REV: A |
| | STANDARD: NON-JEDEC | |
| | 07 MAR 2013 | |

NOTES:

1. INTERPRET DIMENSIONS AND TOLERANCES PER ASME Y14.5M-1994.
2. CONTROLLING DIMENSION: INCH

3. DIMENSION A1 IS MEASURED WITH REFERENCE TO DATUM T. THE POSITIVE VALUE IMPLIES THAT THE PACKAGE BOTTOM IS HIGHER THAN THE LEAD BOTTOM.

| DIM | INCHES | | MILLIMETERS | | DIM | INCHES | | MILLIMETERS | |
|---|----------|-------|--------------------|-------|--------------------------------------|----------------------------|-------|-------------|-------|
| | MIN | MAX | MIN | MAX | | MIN | MAX | MIN | MAX |
| AA | 1.265 | 1.275 | 32.13 | 32.39 | R | .355 | .365 | 9.02 | 9.27 |
| A1 | -.001 | .011 | -0.03 | 0.28 | S | .365 | .375 | 9.27 | 9.53 |
| BB | .395 | .405 | 10.03 | 10.29 | Z | R.000 | R.040 | R0.00 | R1.02 |
| B1 | .564 | .574 | 14.32 | 14.58 | t* | 0* | 8* | 0* | 8* |
| CC | .170 | .190 | 4.32 | 4.83 | | | | | |
| D | .455 | .465 | 11.56 | 11.81 | aaa | .013 | | 0.33 | |
| E | .062 | .066 | 1.57 | 1.68 | bbb | .010 | | 0.25 | |
| F | .004 | .007 | 0.10 | 0.18 | ccc | .020 | | 0.51 | |
| J | .540 BSC | | 13.72 BSC | | | | | | |
| L | .038 | .046 | 0.97 | 1.17 | | | | | |
| L1 | .01 BSC | | 0.25 BSC | | | | | | |
| M | 1.219 | 1.241 | 30.96 | 31.52 | | | | | |
| N | 1.218 | 1.242 | 30.94 | 31.55 | | | | | |
| © FREESCALE SEMICONDUCTOR, INC. ALL RIGHTS RESERVED. | | | MECHANICAL OUTLINE | | | PRINT VERSION NOT TO SCALE | | | |
| TITLE: | | | | | DOCUMENT NO: 98ASA00459D REV: A | | | | |
| NI-1230-4S GULL | | | | | STANDARD: NON-JEDEC | | | | |
| | | | | | 07 MAR 2013 | | | | |

PRODUCT DOCUMENTATION AND SOFTWARE

Refer to the following documents and software to aid your design process.

Application Notes

- AN1955: Thermal Measurement Methodology of RF Power Amplifiers

Engineering Bulletins

- EB212: Using Data Sheet Impedances for RF LDMOS Devices

Software

- Electromigration MTTF Calculator
- RF High Power Model
- .s2p File

For Software, do a Part Number search at <http://www.freescale.com>, and select the “Part Number” link. Go to the Software & Tools tab on the part’s Product Summary page to download the respective tool.

REVISION HISTORY

The following table summarizes revisions to this document.

| Revision | Date | Description |
|----------|-----------|--|
| 0 | Nov. 2010 | <ul style="list-style-type: none"> • Initial Release of Data Sheet |
| 1 | Jan. 2011 | <ul style="list-style-type: none"> • Fig. 1, Pin Connections, corrected pin 4 label from RF_{out}/V_{GS} to RF_{in}/V_{GS}, p. 1 |
| 2 | May 2012 | <ul style="list-style-type: none"> • Added Application Circuits Typical Performance table, p. 1 • Capable of Handling VSWR bullet: corrected 1250 Peak Output Power value to 1500 and converted to table, pp. 1, 3 • Table 1, Max Ratings: final DC test specification for Drain-Source Voltage changed from +125 to +133 Vdc, p. 2 • Table 3, ESD Protection Characteristics: added the device’s ESD passing level as applicable to each ESD class, p. 2 • Table 4, Off Characteristics: final DC test specification for Drain-Source Breakdown Voltage minimum value changed from 125 to 133 Vdc, p. 2 • Table 4, On Characteristics: added Forward Transconductance, p. 2 • Fig. 10, MTTF versus Junction Temperature - CW: MTTF end temperature on graph changed to match maximum operating junction temperature, p. 7 • Added Fig. 12, Source and Load Impedances Optimized for IRL, Power and Efficiency — Push-pull, p. 8 • Added Fig. 13, 87.5-108 MHz FM Broadcast Reference Circuit Component Layout, p. 9 • Added Table 9, 87.5-108 MHz FM Broadcast Reference Circuit Component Designations and Values, p. 9 • Added Fig. 14, 87.5-108 MHz FM Broadband Reference Circuit Schematic, p. 10 • Added Fig. 15, Power Gain and Drain Efficiency versus Output Power (87.5-108 MHz), p. 11 • Added Fig. 16, Series Equivalent 87.5-108 MHz FM Broadcast Reference Circuit Source and Load Impedance, p. 11 • Added Fig. 17, 144-148 MHz Reference Circuit Component Layout, p. 12 • Added Table 9, 144-148 MHz Reference Circuit Component Designations and Values, p. 12 • Added Fig. 18, 144-148 MHz Reference Circuit Schematic, p. 13 • Added Fig. 19, Series Equivalent 144-148 MHz Reference Circuit Source and Load Impedance, p. 14 • Added Fig. 20, Power Gain and Drain Efficiency versus Output Power (144-148 MHz), p. 14 • Added Fig. 21, Intermodulation Distortion Products versus Output Power (144-148 MHz), p. 14 • Added Fig. 22, 144 MHz Harmonics @ 1 kW, p. 15 |
| 3 | Oct. 2012 | <ul style="list-style-type: none"> • Added part number MRFE6VP61K25GSR5, p. 1 • Added 2282-02 (NI-1230S-4 Gull) package isometric, p. 1, and Mechanical Outline, p. 20, 21 |
| 4 | Mar. 2013 | <ul style="list-style-type: none"> • MRFE6VP61K25HR6 tape and reel option replaced with MRF6VP61K25HR5 per PCN15551. • Replaced Case Outline 98ASB16977C, Issue E with Issue F, p. 16, 17. Changed dimension C from 0.150”-0.200” to CC 0.170”-0.190”. • Replaced Case Outline 98ARB18247C, Issue F with Issue G, p. 18, 19. Changed dimension C from 0.150”-0.200” to CC 0.170”-0.190”. Added minimum Z dimension R0.00”. • Replaced Case Outline 98ASA00459D, Issue O with Issue A, p. 20, 21. Changed dimension C from 0.150”-0.200” to CC 0.170”-0.190”. Corrected positional tolerance for dimension S. |
| 4.1 | Mar. 2014 | <ul style="list-style-type: none"> • MRFE6VP61K25HR5 part added to data sheet device box, p. 1 • MRFE6VP61K25HSR6 tape and reel option replaced with MRFE6VP61K25HSR5 per PCN15551. (Note: this copy updates the copy from Rev. 4 Revision History to accurately reflect the part number replacement in this data sheet as described in PCN15551.) |

MRFE6VP61K25HR6 MRFE6VP61K25HR5 MRFE6VP61K25HSR5 MRFE6VP61K25GSR5

How to Reach Us:

Home Page:
freescale.com

Web Support:
freescale.com/support

Information in this document is provided solely to enable system and software implementers to use Freescale products. There are no express or implied copyright licenses granted hereunder to design or fabricate any integrated circuits based on the information in this document.

Freescale reserves the right to make changes without further notice to any products herein. Freescale makes no warranty, representation, or guarantee regarding the suitability of its products for any particular purpose, nor does Freescale assume any liability arising out of the application or use of any product or circuit, and specifically disclaims any and all liability, including without limitation consequential or incidental damages. "Typical" parameters that may be provided in Freescale data sheets and/or specifications can and do vary in different applications, and actual performance may vary over time. All operating parameters, including "typicals," must be validated for each customer application by customer's technical experts. Freescale does not convey any license under its patent rights nor the rights of others. Freescale sells products pursuant to standard terms and conditions of sale, which can be found at the following address: freescale.com/SalesTermsandConditions.

Freescale and the Freescale logo are trademarks of Freescale Semiconductor, Inc., Reg. U.S. Pat. & Tm. Off. All other product or service names are the property of their respective owners.

© 2014 Freescale Semiconductor, Inc.

