

# RF Power LDMOS Transistors

## High Ruggedness N-Channel Enhancement-Mode Lateral MOSFETs

These high ruggedness devices are designed for use in high VSWR industrial (including laser and plasma exciters), broadcast (analog and digital), aerospace and radio/land mobile applications. They are unmatched input and output designs allowing wide frequency range utilization, between 1.8 and 600 MHz.

- Typical Performance:  $V_{DD} = 50$  Volts,  $I_{DQ} = 100$  mA

Signal Type	$P_{out}$ (W)	f (MHz)	$G_{ps}$ (dB)	$\eta_D$ (%)
Pulse (100 $\mu$ sec, 20% Duty Cycle)	1250 Peak	230	24.0	74.0
CW	1250 CW	230	22.9	74.6

### Application Circuits (1) — Typical Performance

Frequency (MHz)	Signal Type	$P_{out}$ (W)	$G_{ps}$ (dB)	$\eta_D$ (%)
27	CW	1300	27	81
40	CW	1300	26	85
81.36	CW	1250	27	84
87.5-108	CW	1100	24	80
144-148	CW	1250	26	78
170-230	DVB-T	225	25	30
352	Pulse (200 $\mu$ sec, 20% Duty Cycle)	1250	21.5	66
352	CW	1150	20.5	68
500	CW	1000	18	58

1. Contact your local Freescale sales office for additional information on specific circuit designs.

### Load Mismatch/Ruggedness

Frequency (MHz)	Signal Type	VSWR	$P_{out}$ (W)	Test Voltage	Result
230	Pulse (100 $\mu$ sec, 20% Duty Cycle)	> 65:1 at all Phase Angles	1500 Peak (3 dB Overdrive)	50	No Device Degradation

### Features

- Unmatched Input and Output Allowing Wide Frequency Range Utilization
- Device can be used Single-Ended or in a Push-Pull Configuration
- Qualified Up to a Maximum of 50  $V_{DD}$  Operation
- Characterized from 30 V to 50 V for Extended Power Range
- Suitable for Linear Application with Appropriate Biasing
- Integrated ESD Protection with Greater Negative Gate-Source Voltage Range for Improved Class C Operation
- Characterized with Series Equivalent Large-Signal Impedance Parameters
- In Tape and Reel. R6 Suffix = 150 Units, 56 mm Tape Width, 13-inch Reel. R5 Suffix = 50 Units, 56 mm Tape Width, 13-inch Reel.

**MRFE6VP61K25HR6**  
**MRFE6VP61K25HR5**  
**MRFE6VP61K25HSR5**  
**MRFE6VP61K25GSR5**

**1.8-600 MHz, 1250 W CW, 50 V  
WIDEBAND  
RF POWER LDMOS TRANSISTORS**

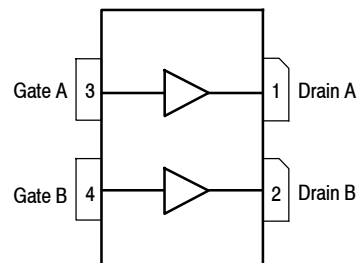
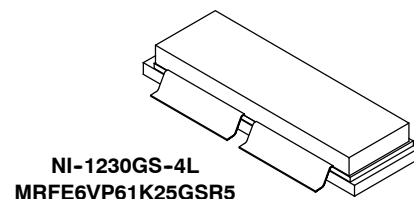
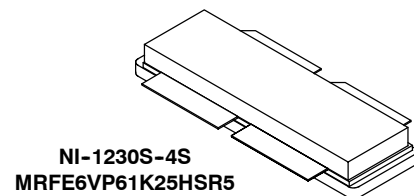
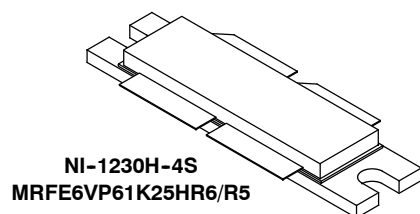

(Top View)

Note: The backside of the package is the source terminal for the transistors.

**Figure 1. Pin Connections**

**Table 1. Maximum Ratings**

Rating	Symbol	Value	Unit
Drain-Source Voltage	$V_{DS}$	-0.5, +133	Vdc
Gate-Source Voltage	$V_{GS}$	-6.0, +10	Vdc
Storage Temperature Range	$T_{stg}$	-65 to +150	°C
Case Operating Temperature	$T_C$	150	°C
Operating Junction Temperature (1,2)	$T_J$	225	°C
Total Device Dissipation @ $T_C = 25^\circ\text{C}$ Derate above 25°C	$P_D$	1333 6.67	W W/°C

**Table 2. Thermal Characteristics**

Characteristic	Symbol	Value (2,3)	Unit
Thermal Resistance, Junction to Case CW: Case Temperature 63°C, 1250 W CW, $I_{DQ} = 100$ mA, 230 MHz	$R_{\theta JC}$	0.15	°C/W
Thermal Impedance, Junction to Case Pulse: Case Temperature 66°C, 1250 W Pulse, 100 $\mu\text{sec}$ Pulse Width, 20% Duty Cycle, $I_{DQ} = 100$ mA, 230 MHz	$Z_{\theta JC}$	0.03	°C/W

**Table 3. ESD Protection Characteristics**

Test Methodology	Class
Human Body Model (per JESD22-A114)	2, passes 3500 V
Machine Model (per EIA/JESD22-A115)	B, passes 250 V
Charge Device Model (per JESD22-C101)	IV, passes 4000 V

**Table 4. Electrical Characteristics** ( $T_A = 25^\circ\text{C}$  unless otherwise noted)

Characteristic	Symbol	Min	Typ	Max	Unit
----------------	--------	-----	-----	-----	------

**Off Characteristics (4)**

Gate-Source Leakage Current ( $V_{GS} = 5$ Vdc, $V_{DS} = 0$ Vdc)	$I_{GSS}$	—	—	1	$\mu\text{Adc}$
Drain-Source Breakdown Voltage ( $V_{GS} = 0$ Vdc, $I_D = 100$ mA)	$V_{(BR)DSS}$	133	—	—	Vdc
Zero Gate Voltage Drain Leakage Current ( $V_{DS} = 50$ Vdc, $V_{GS} = 0$ Vdc)	$I_{DSS}$	—	—	10	$\mu\text{Adc}$
Zero Gate Voltage Drain Leakage Current ( $V_{DS} = 100$ Vdc, $V_{GS} = 0$ Vdc)	$I_{DSS}$	—	—	20	$\mu\text{Adc}$

**On Characteristics**

Gate Threshold Voltage (4) ( $V_{DS} = 10$ Vdc, $I_D = 1776$ $\mu\text{Adc}$ )	$V_{GS(th)}$	1.7	2.2	2.7	Vdc
Gate Quiescent Voltage ( $V_{DD} = 50$ Vdc, $I_D = 100$ mA, Measured in Functional Test)	$V_{GS(Q)}$	1.9	2.2	2.9	Vdc
Drain-Source On-Voltage (4) ( $V_{GS} = 10$ Vdc, $I_D = 2$ Adc)	$V_{DS(on)}$	—	0.15	—	Vdc
Forward Transconductance ( $V_{DS} = 10$ Vdc, $I_D = 30$ Adc)	$g_{fs}$	—	28.0	—	S

**Dynamic Characteristics (4)**

Reverse Transfer Capacitance ( $V_{DS} = 50$ Vdc $\pm$ 30 mV(rms)ac @ 1 MHz, $V_{GS} = 0$ Vdc)	$C_{rss}$	—	2.8	—	pF
Output Capacitance ( $V_{DS} = 50$ Vdc $\pm$ 30 mV(rms)ac @ 1 MHz, $V_{GS} = 0$ Vdc)	$C_{oss}$	—	185	—	pF
Input Capacitance ( $V_{DS} = 50$ Vdc, $V_{GS} = 0$ Vdc $\pm$ 30 mV(rms)ac @ 1 MHz)	$C_{iss}$	—	562	—	pF

1. Continuous use at maximum temperature will affect MTTF.
2. MTTF calculator available at <http://www.freescale.com/rf>. Select Software & Tools/Development Tools/Calculators to access MTTF calculators by product.
3. Refer to AN1955, *Thermal Measurement Methodology of RF Power Amplifiers*. Go to <http://www.freescale.com/rf>. Select Documentation/Application Notes - AN1955.
4. Each side of device measured separately.

(continued)

**MRFE6VP61K25HR6 MRFE6VP61K25HR5 MRFE6VP61K25HSR5 MRFE6VP61K25GSR5**

**Table 4. Electrical Characteristics** ( $T_A = 25^\circ\text{C}$  unless otherwise noted) (continued)

Characteristic	Symbol	Min	Typ	Max	Unit
<b>Functional Tests</b> <sup>(1)</sup> (In Freescale Test Fixture, 50 ohm system) $V_{DD} = 50\text{ Vdc}$ , $I_{DQ} = 100\text{ mA}$ , $P_{out} = 1250\text{ W Peak}$ (250 W Avg.), $f = 230\text{ MHz}$ , 100 $\mu\text{sec}$ Pulse Width, 20% Duty Cycle					
Power Gain	$G_{ps}$	23.0	24.0	26.0	dB
Drain Efficiency	$\eta_D$	72.5	74.0	—	%
Input Return Loss	IRL	—	-14	-10	dB

**Table 5. Load Mismatch/Ruggedness** (In Freescale Test Fixture, 50 ohm system)  $I_{DQ} = 100\text{ mA}$ 

Frequency (MHz)	Signal Type	VSWR	$P_{out}$ (W)	Test Voltage, $V_{DD}$	Result
230	Pulse (100 $\mu\text{sec}$ , 20% Duty Cycle)	> 65:1 at all Phase Angles	1500 Peak (3 dB Overdrive)	50	No Device Degradation

1. Measurements made with device in straight lead configuration before any lead forming operation is applied. Lead forming is used for gull wing (GS) parts.

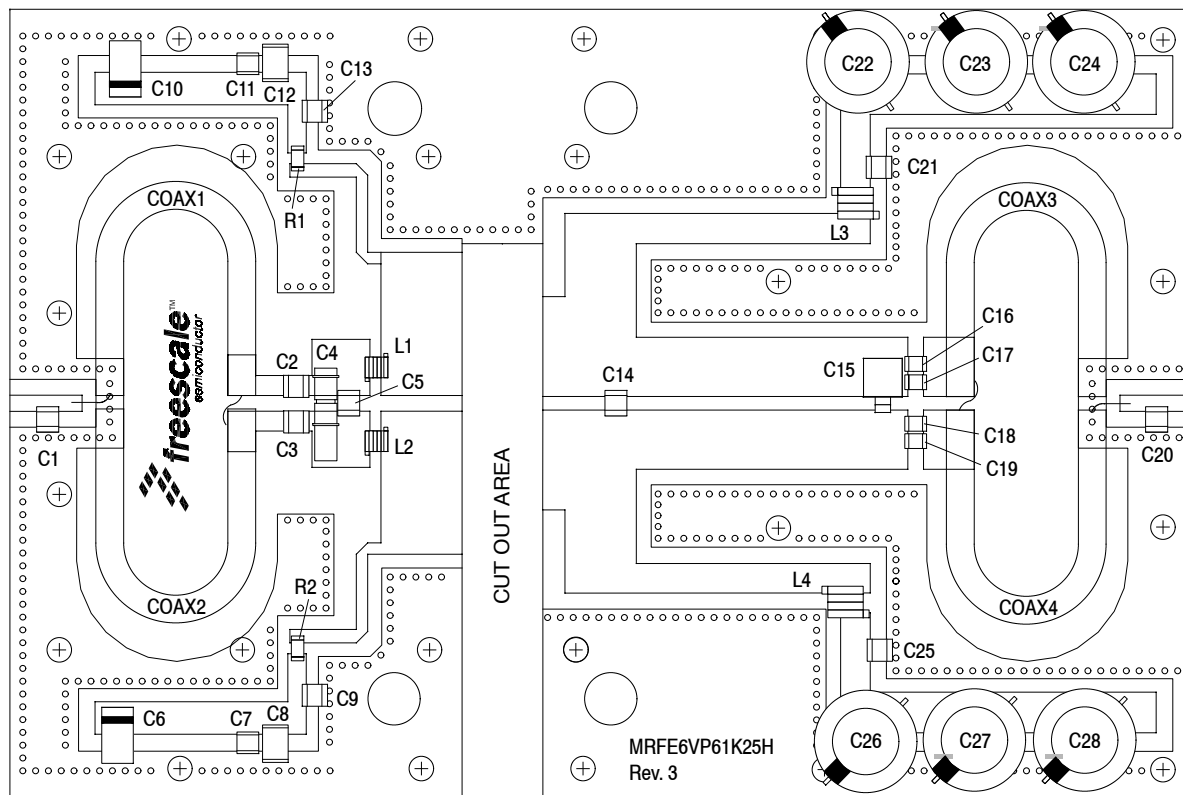

Figure 2. MRFE6VP61K25HR6(HSR6) 230 MHz Production Test Circuit Component Layout — Pulse

Table 6. MRFE6VP61K25HR6(HSR6) 230 MHz Production Test Circuit Component Designations and Values — Pulse

Part	Description	Part Number	Manufacturer
C1	20 pF Chip Capacitor	ATC100B200JT500XT	ATC
C2, C3, C5	27 pF Chip Capacitors	ATC100B270JT500XT	ATC
C4	0.8–8.0 pF Variable Capacitor, Gigatrim	27291SL	Johanson
C6, C10	22 $\mu$ F, 35 V Tantalum Capacitors	T491X226K035AT	Kemet
C7, C11	0.1 $\mu$ F Chip Capacitors	CDR33BX104AKYS	AVX
C8, C12	220 nF Chip Capacitors	C1812C224K5RACTU	Kemet
C9, C13, C21, C25	1000 pF Chip Capacitors	ATC100B102JT50XT	ATC
C14	43 pF Chip Capacitor	ATC100B430JT500XT	ATC
C15	75 pF Metal Mica	MIN02-002EC750J-F	CDE
C16, C17, C18, C19	240 pF Chip Capacitors	ATC100B241JT200XT	ATC
C20	6.2 pF Chip Capacitor	ATC100B6R2BT500XT	ATC
C22, C23, C24, C26, C27, C28	470 $\mu$ F, 63 V Electrolytic Capacitors	MCGPR63V477M13X26-RH	Multicomp
Coax1, 2, 3, 4	25 $\Omega$ Semi Rigid Coax, 2.2" Shield Length	UT-141C-25	Micro-Coax
L1, L2	5 nH Inductors	A02TKLC	Coilcraft
L3, L4	6.6 nH Inductors	GA3093-ALC	Coilcraft
R1, R2	10 $\Omega$ Chip Resistors	CRCW120610R0JNEA	Vishay
PCB	0.030", $\epsilon_r = 2.55$	AD255A	Arlon

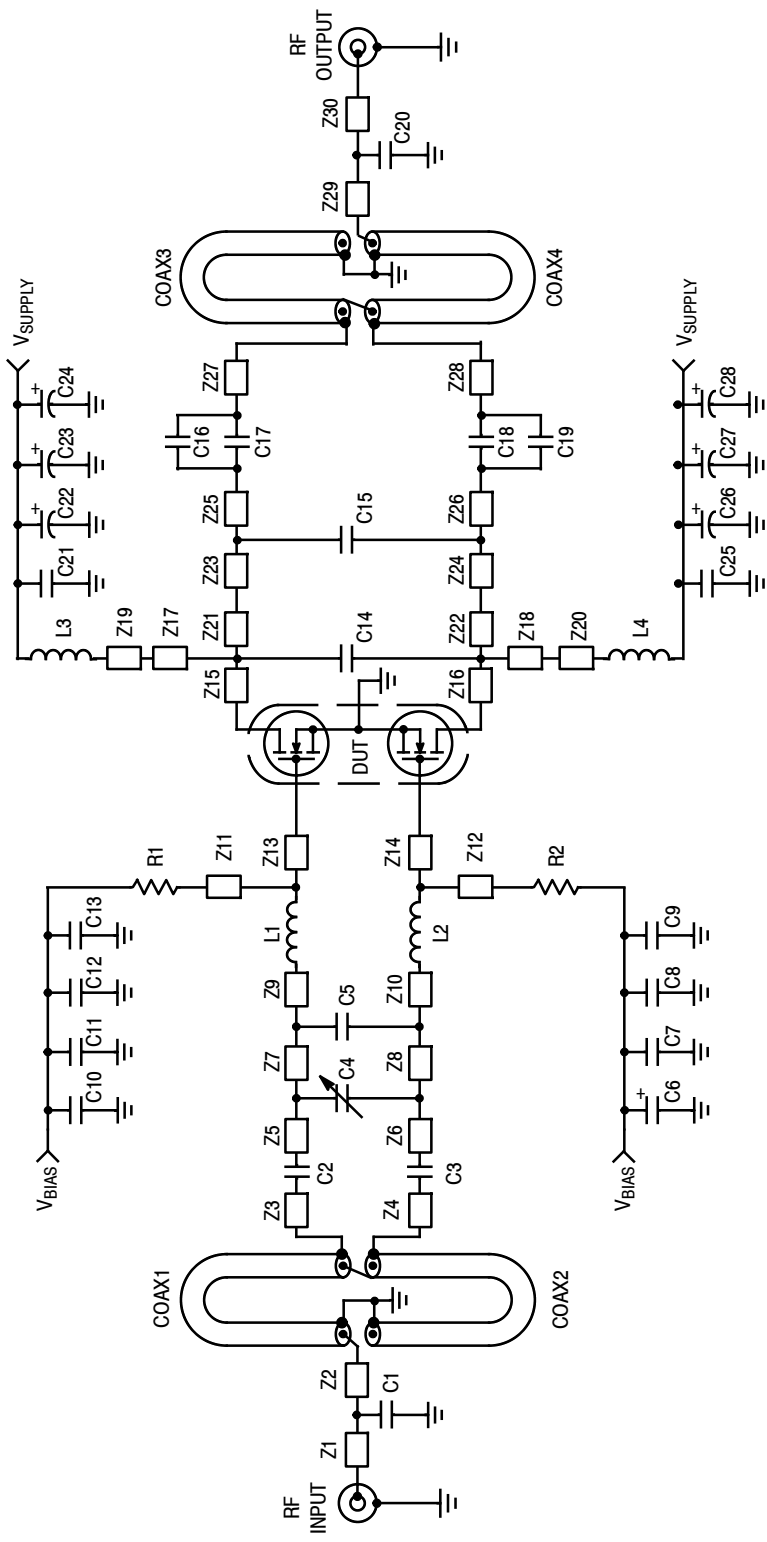

Figure 3. MRFE6VP61K25HR6(HSR6) 230 MHz Production Test Circuit Schematic — Pulse

Table 7. MRFE6VP61K25HR6(HSR6) 230 MHz Production Test Circuit Microstrips — Pulse

Microstrip	Description	Microstrip	Description	Microstrip	Description
Z1	0.192" x 0.082" Microstrip	Z11*, Z12*	0.872" x 0.058" Microstrip	Z23, Z24	1.251" x 0.300" Microstrip
Z2	0.175" x 0.082" Microstrip	Z13, Z14	0.412" x 0.726" Microstrip	Z25, Z26	0.127" x 0.300" Microstrip
Z3, Z4	0.170" x 0.100" Microstrip	Z15, Z16	0.371" x 0.507" Microstrip	Z27, Z28	0.116" x 0.300" Microstrip
Z5, Z6	0.116" x 0.285" Microstrip	Z17*, Z18*	0.466" x 0.363" Microstrip	Z29	0.186" x 0.082" Microstrip
Z7, Z8	0.116" x 0.285" Microstrip	Z19*, Z20*	0.187" x 0.154" Microstrip	Z30	0.179" x 0.082" Microstrip
Z9, Z10	0.108" x 0.285" Microstrip	Z21, Z22	0.104" x 0.507" Microstrip		

\* Line length includes microstrip bends

## TYPICAL CHARACTERISTICS

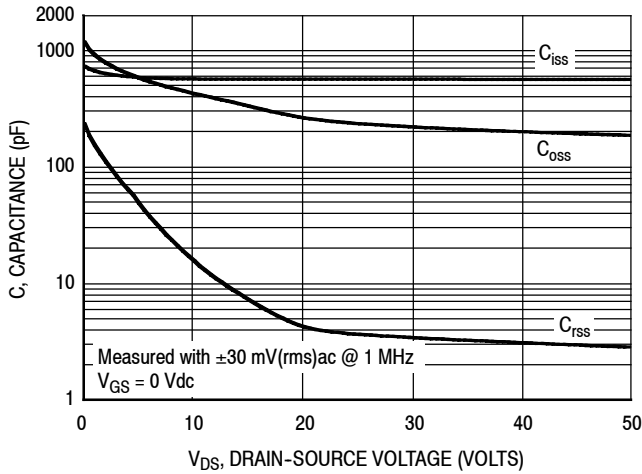

Note: Each side of device measured separately.

Figure 4. Capacitance versus Drain-Source Voltage

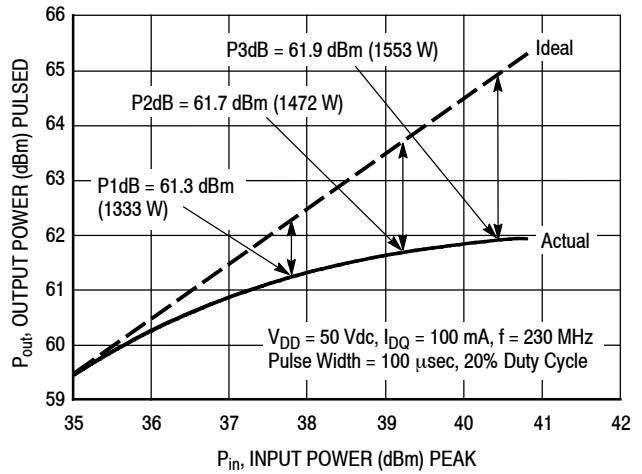

Figure 5. Output Power versus Input Power

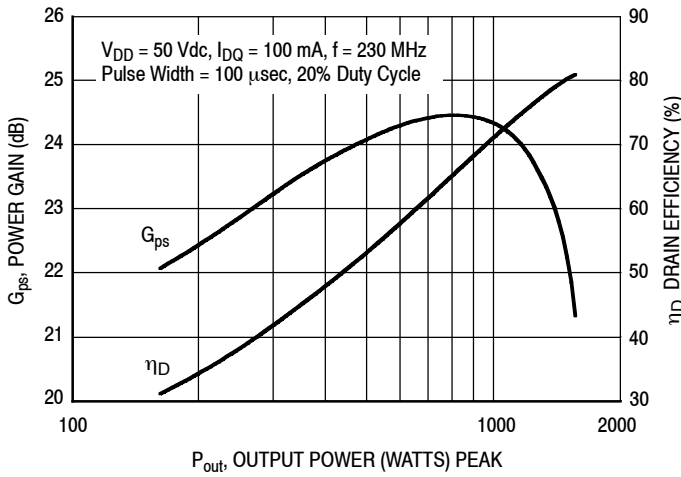

Figure 6. Power Gain and Drain Efficiency versus Output Power

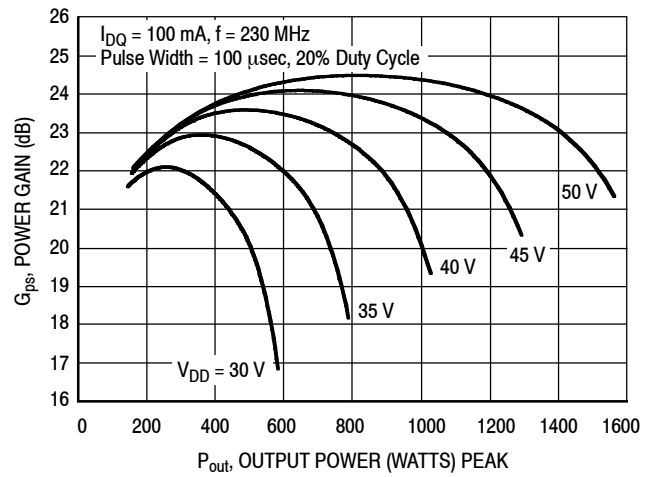

Figure 7. Power Gain versus Output Power

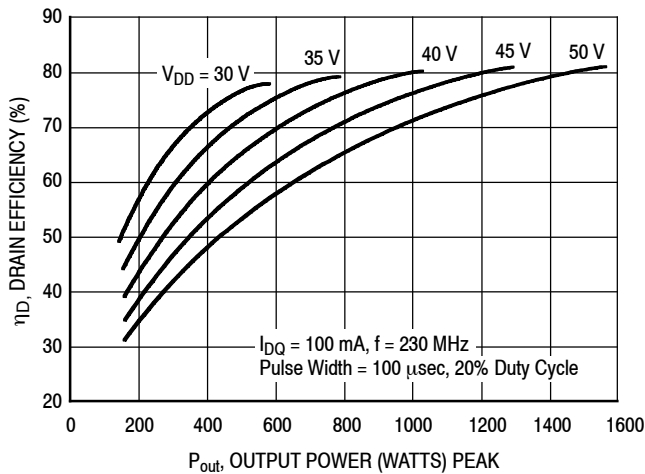

Figure 8. Drain Efficiency versus Output Power

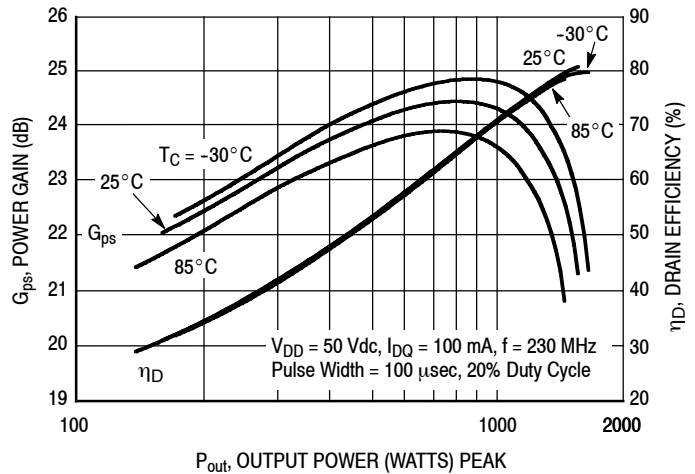
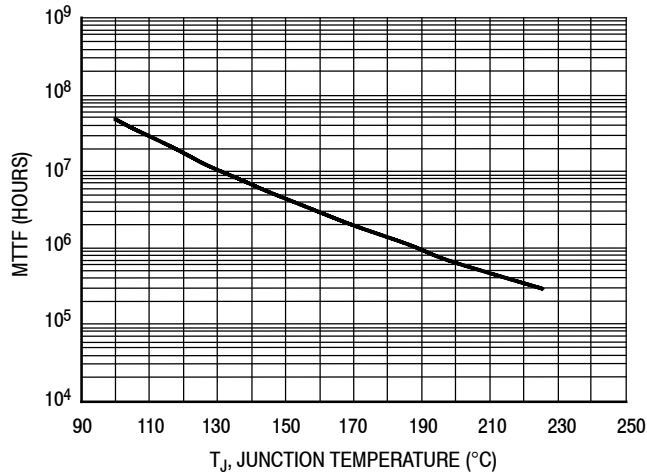

Figure 9. Power Gain and Drain Efficiency versus Output Power

## TYPICAL CHARACTERISTICS



This above graph displays calculated MTTF in hours when the device is operated at  $V_{DD} = 50$  Vdc,  $P_{out} = 1250$  W CW, and  $\eta_D = 74.6\%$ .

MTTF calculator available at <http://www.freescale.com/rf>. Select Software & Tools/Development Tools/Calculators to access MTTF calculators by product.

**Figure 10. MTTF versus Junction Temperature — CW**

$V_{DD} = 50$  Vdc,  $I_{DQ} = 100$  mA,  $P_{out} = 1250$  W Peak

f MHz	Z <sub>source</sub> Ω	Z <sub>load</sub> Ω
230	1.29 + j3.54	2.12 + j2.68

Z<sub>source</sub> = Test circuit impedance as measured from gate to gate, balanced configuration.

Z<sub>load</sub> = Test circuit impedance as measured from drain to drain, balanced configuration.

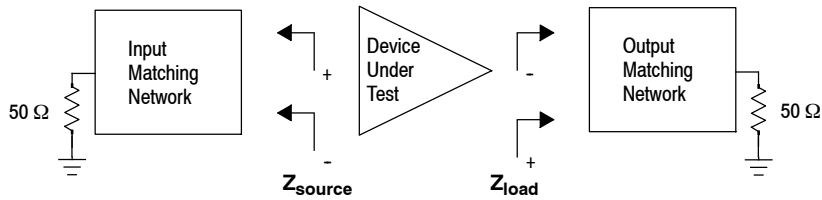

**Figure 11. Series Equivalent Test Circuit Source and Load Impedance — 230 MHz Pulse**

$V_{DD} = 50 \text{ Vdc}$ ,  $I_{DQ} = 100 \text{ mA}$

f (MHz)	$Z_{\text{source}}$ ( $\Omega$ )	$Z_{\text{load}}$ ( $\Omega$ )
1.8 (1)	$34.4 + j192.0$ (1)	$5.00 - j4.00$ (1)
27	$12.5 + j7.00$	$7.00 + j0.70$
40	$5.75 + j5.06$	$5.39 + j2.62$
81.36	$4.04 + j5.93$	$4.89 + j2.95$
88	$2.20 + j6.70$	$4.90 + j2.90$
98	$2.30 + j6.90$	$4.10 + j2.50$
108	$2.30 + j7.00$	$4.40 + j3.60$
144	$1.60 + j5.00$	$3.90 + j1.50$
175	$1.33 + j3.90$	$3.50 + j2.50$
230	$1.29 + j3.54$	$2.12 + j2.68$
352	$0.98 + j1.45$	$1.82 + j2.05$
500	$0.29 + j1.47$	$1.79 + j1.80$

1. Simulated data.

$Z_{\text{source}}$  = Test circuit impedance as measured from gate to gate, balanced configuration.

$Z_{\text{load}}$  = Test circuit impedance as measured from drain to drain, balanced configuration.

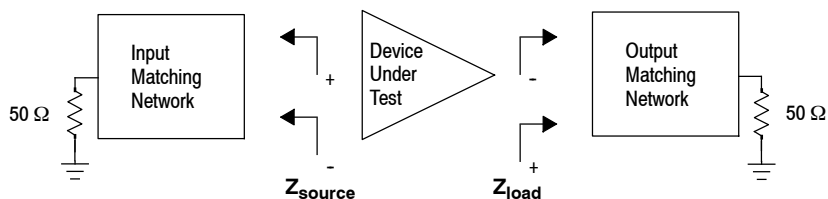
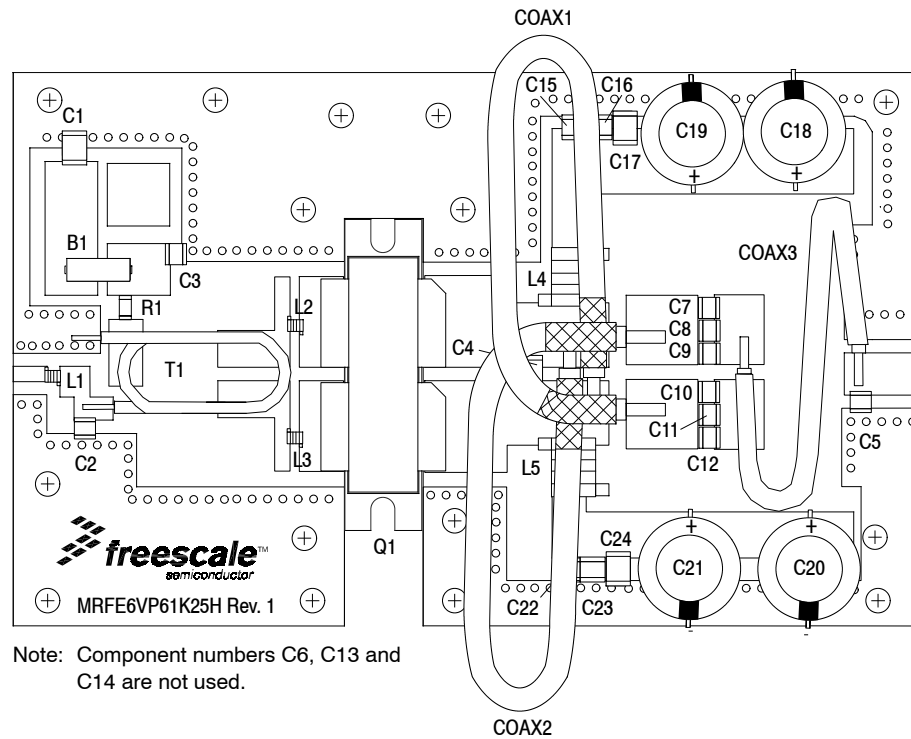

Figure 12. Source and Load Impedances Optimized for IRL, Power and Efficiency — Push-Pull



## 87.5-108 MHz FM BROADCAST REFERENCE CIRCUIT



**Figure 13. MRFE6VP61K25HR6(HSR6) 87.5-108 MHz FM Broadcast Reference Circuit Component Layout**

**Table 8. MRFE6VP61K25HR6(HSR6) 87.5-108 MHz FM Broadcast Reference Circuit Component Designations and Values**

Part	Description	Part Number	Manufacturer
B1	Long Ferrite Bead	2743021447	Fair-Rite
C1	6.8 $\mu$ F, 50 V Chip Capacitor	C4532X7R1H685K	TDK
C2	27 pF Chip Capacitor	ATC100B270JT500XT	ATC
C3, C7, C8, C9, C10, C11, C12	1000 pF Chip Capacitors	ATC100B102JT50XT	ATC
C4	39 pF Mica Capacitor	MIN02-002DC390J-F	Cornell Dubilier
C5	3 pF Chip Capacitor	ATC100B3R0CT500XT	ATC
C15, C22	10K pF Chip Capacitors	ATC200B103KT50XT	ATC
C16, C23	1 $\mu$ F, 100 V Chip Capacitors	C3225JB2A105KT	TDK
C17, C24	10 $\mu$ F, 100 V Chip Capacitors	C5750X7S2A106MT	TDK
C18, C19, C20, C21	470 $\mu$ F, 63 V Electrolytic Capacitors	MCGPR63V477M13X26-RH	Multicomp
L1	39 nH Inductor	1812SMS-39NJLC	Coilcraft
L2, L3	2.5 nH Inductors	A01TKLC	Coilcraft
L4, L5	7 Turn, #16 AWG, ID = 0.3" Inductors	Copper Wire	
Q1	RF Power LDMOS Transistor	MRFE6VP61K25HR6	Freescale
R1	11 $\Omega$ , 1/4 W Chip Resistor	CRCW120611R0FKEA	Vishay
T1	Balun	TUI-9	Comm Concepts
Coax1, Coax2	Flex Cables (12 $\Omega$ ) 5.9"	TC-12	Comm Concepts
Coax3	Coax Cable, Quickform 50 $\Omega$ , 8.7"	SUCOFORM 250-01	Huber+Suhner
PCB	0.030", $\epsilon_r = 3.5$	TC-350	Arlon
Heatsink	NI-1230 Copper Heatsink	C193X280T970	Machine Shop

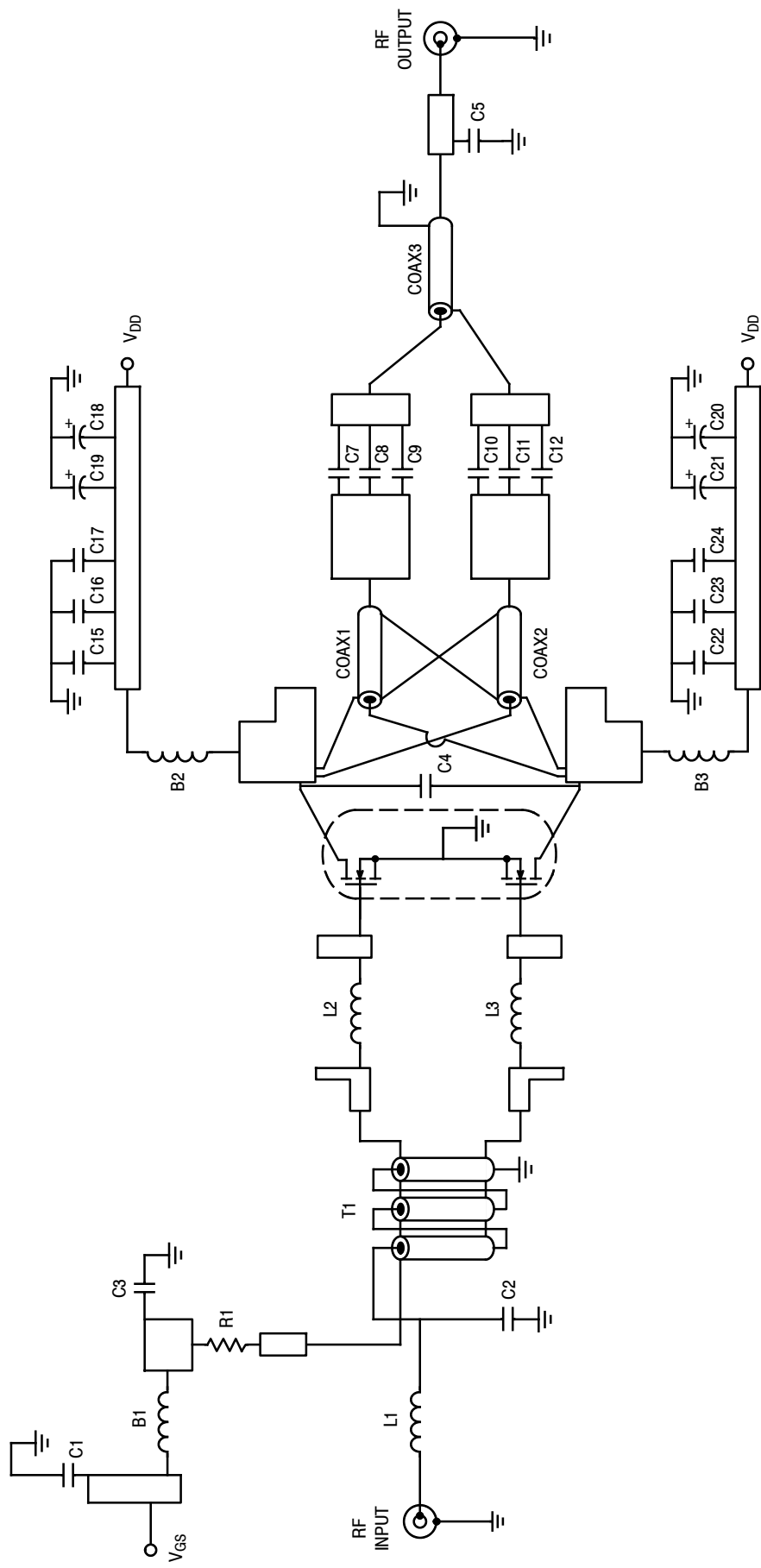

Figure 14. MRFE6VP61K25HR6(HSR6) 87.5-108 MHz FM Broadcast Reference Circuit Schematic

MRFE6VP61K25HR6 MRFE6VP61K25HR5 MRFE6VP61K25HSR5 MRFE6VP61K25GSR5

TYPICAL CHARACTERISTICS — 87.5-108 MHz FM BROADCAST REFERENCE CIRCUIT

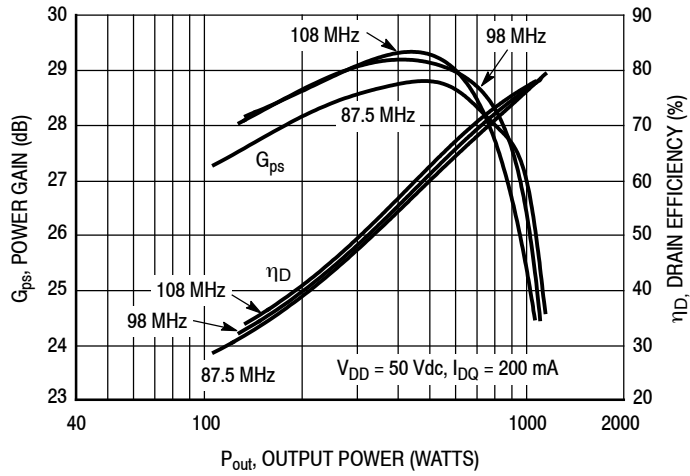

Figure 15. Power Gain and Drain Efficiency versus Output Power

$V_{DD} = 50 \text{ Vdc}$ ,  $I_{DQ} = 200 \text{ mA}$ ,  $P_{out} = 1100 \text{ W CW}$

f MHz	$Z_{source} \Omega$	$Z_{load} \Omega$
87.5	$2.20 + j6.70$	$4.90 + j2.90$
98	$2.30 + j6.90$	$4.10 + j2.50$
108	$2.30 + j7.00$	$4.40 + j3.60$

$Z_{source}$  = Test circuit impedance as measured from gate to gate, balanced configuration.

$Z_{load}$  = Test circuit impedance as measured from drain to drain, balanced configuration.

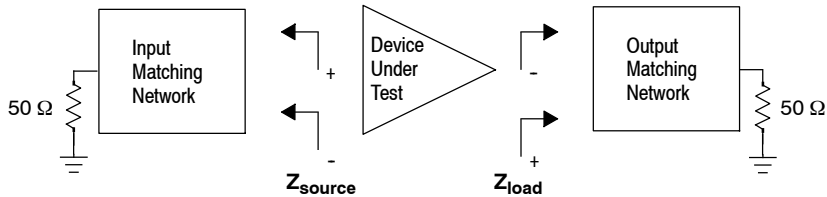
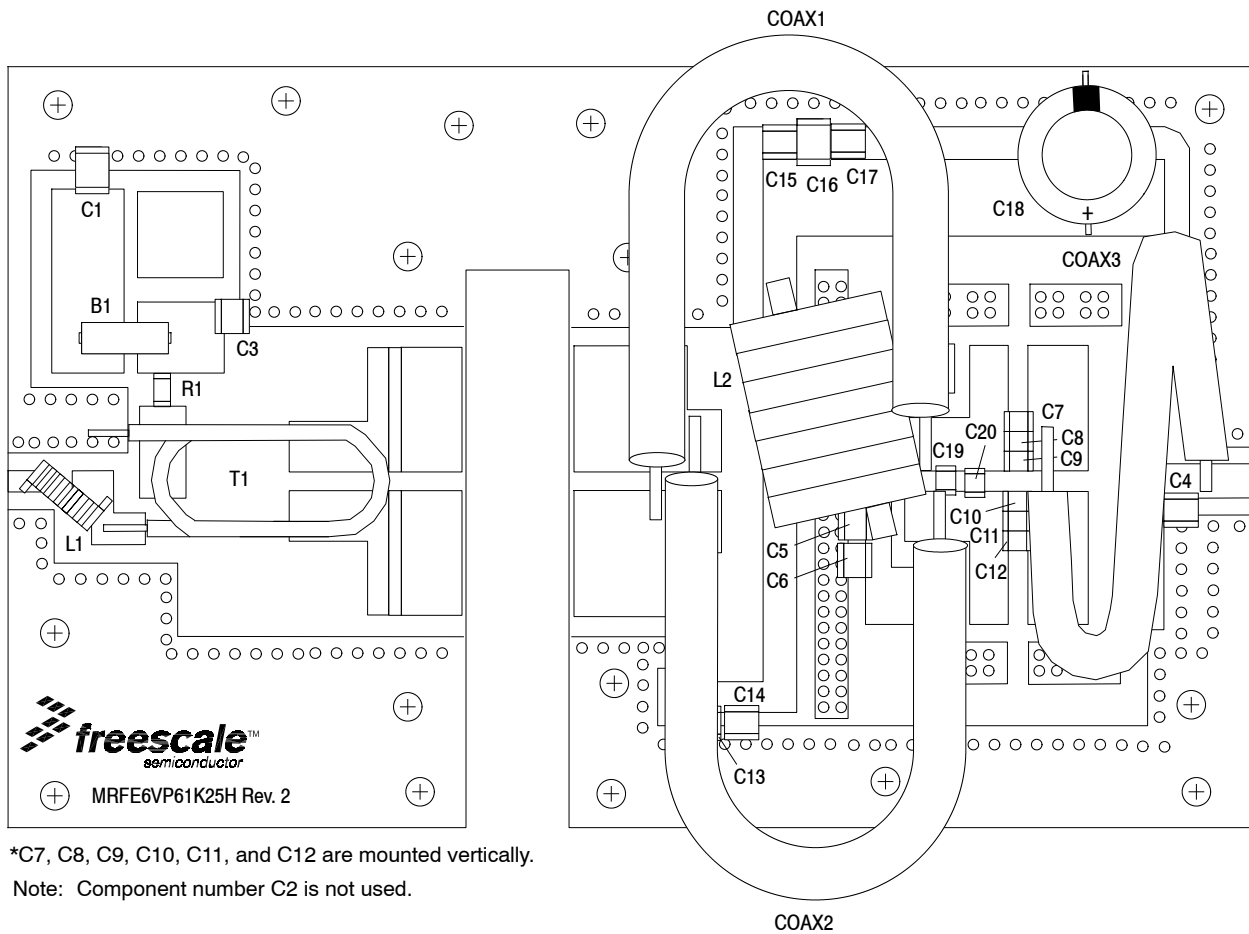

Figure 16. Series Equivalent 87.5-108 MHz FM Broadcast Reference Circuit Source and Load Impedance

## 144-148 MHz REFERENCE CIRCUIT



\*C7, C8, C9, C10, C11, and C12 are mounted vertically.

Note: Component number C2 is not used.

**Figure 17. MRFE6VP61K25HR6(HSR6) 144-148 MHz Reference Circuit Component Layout**

**Table 9. MRFE6VP61K25HR6(HSR6) 144-148 MHz Reference Circuit Component Designations and Values**

Part	Description	Part Number	Manufacturer
B1	95 Ω, 100 MHz Long Ferrite Bead	2743021447	Fair-Rite
C1	6.8 μF, 50 V Chip Capacitor	C4532X7R1H685K	TDK
C3, C5, C7, C8, C9, C10, C11, C12, C13, C15	1000 pF Chip Capacitors	ATC100B102KT50XT	ATC
C4	5.6 pF Chip Capacitor	ATC100B5R6CT500XT	ATC
C6	470 pF Chip Capacitor	ATC100B471JT200XT	ATC
C14, C16	1 μF, 100 V Chip Capacitors	C3225JB2A105KT	TDK
C17	2.2 μF, 100 V Chip Capacitor	HMK432B7225KM-T	Taiyo Yuden
C18	470 μF, 100 V Electrolytic Capacitor	MCGPR100V477M16X32-RH	Multicomp
C19, C20	15 pF Chip Capacitors	ATC100B150JT500XT	ATC
L1	43 nH Inductor	B10TJLC	Coilcraft
L2	7 Turn, #14 AWG, ID = 0.4" Inductor	Handwound	Freescale
R1	11 Ω, 1/4 W Chip Resistor	CRCW120611R0FKEA	Vishay
T1	Balun	TUI-9	Comm Concepts
Coax1, Coax2	Flex Cables, 10.2 Ω, 4.7"	TC-12	Comm Concepts
Coax3	Coax Cable, 50 Ω, 6.7"	SUCOFORM250-01	Huber+Suhner
PCB	0.030", ε <sub>r</sub> = 3.50	TC-350	Arlon

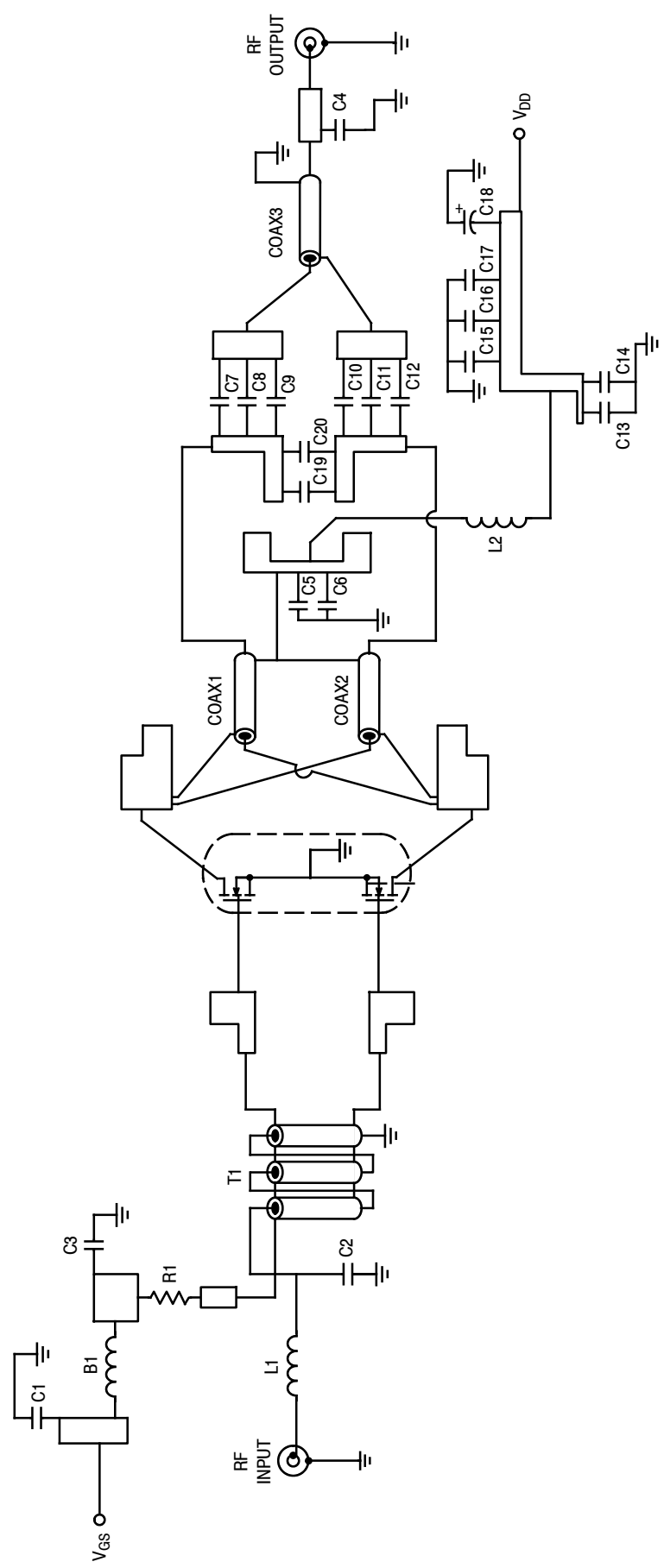

Figure 18. MRFE6VP61K25HR6(HSR6) 144-148 MHz Reference Circuit Schematic

MRFE6VP61K25HR6 MRFE6VP61K25HR5 MRFE6VP61K25HSR5 MRFE6VP61K25GSR5

## TYPICAL CHARACTERISTICS — 144-148 MHz REFERENCE CIRCUIT

$V_{DD} = 50 \text{ Vdc}$ ,  $I_{DQ} = 200 \text{ mA}$ ,  $P_{out} = 1100 \text{ W CW}$

f MHz	$Z_{source}$ $\Omega$	$Z_{load}$ $\Omega$
144	$1.6 + j5.0$	$3.9 + j1.5$

$Z_{source}$  = Test circuit impedance as measured from gate to gate, balanced configuration.

$Z_{load}$  = Test circuit impedance as measured from drain to drain, balanced configuration.

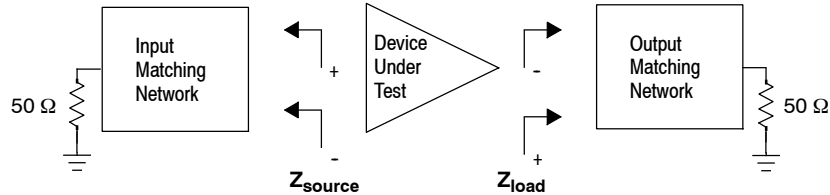

Figure 19. Series Equivalent 144-148 MHz Reference Circuit Source and Load Impedance

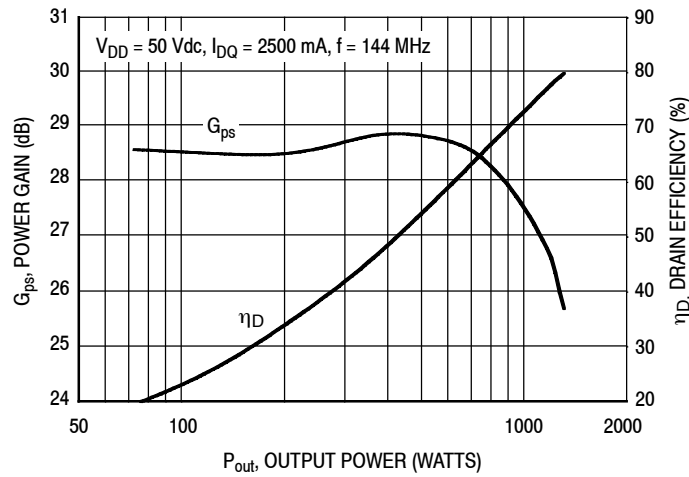

Figure 20. Power Gain and Drain Efficiency versus Output Power

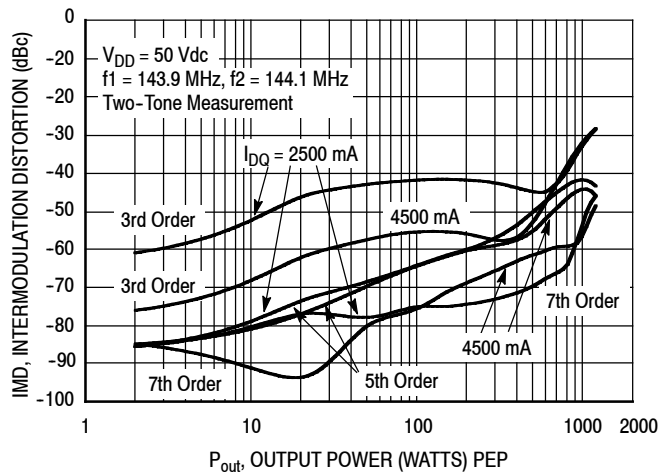
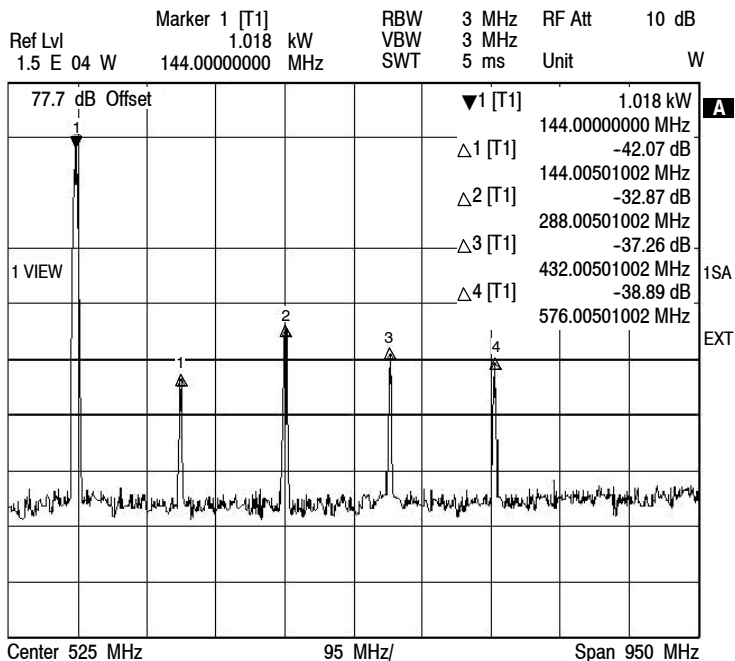

Figure 21. Intermodulation Distortion Products versus Output Power

### HARMONIC MEASUREMENTS



144 MHz, 1 kW

H2	H3	H4	H5
-42 dB	-33 dB	-37 dB	-39 dB

Figure 22. 144 MHz Harmonics @ 1 kW

### PACKAGE DIMENSIONS

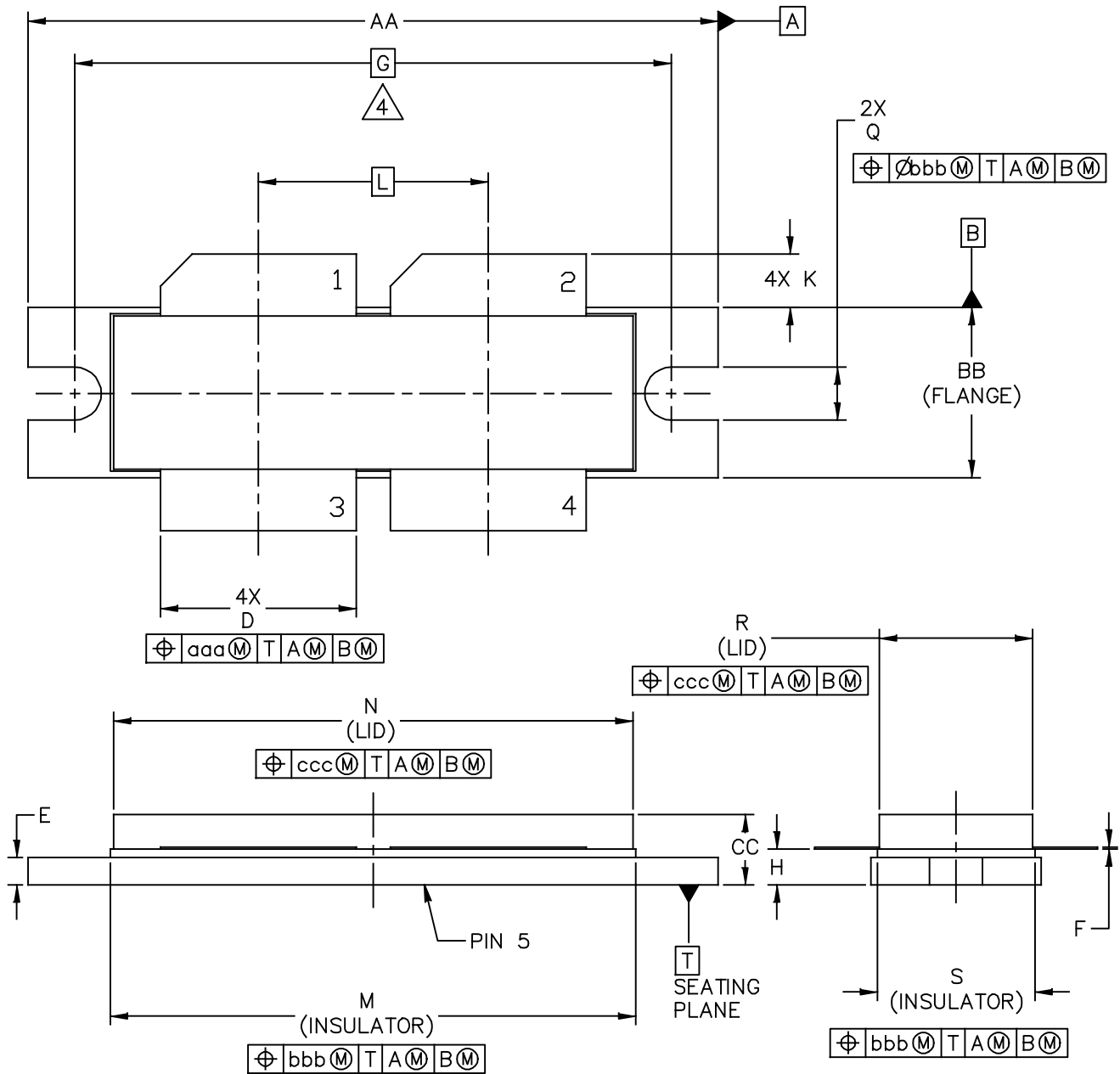

© FREESCALE SEMICONDUCTOR, INC. ALL RIGHTS RESERVED.	MECHANICAL OUTLINE	PRINT VERSION NOT TO SCALE
TITLE:  NI-1230-4H	DOCUMENT NO: 98ASB16977C	REV: F
	STANDARD: NON-JEDEC	
	28 FEB 2013	



NOTES:

1. INTERPRET DIMENSIONS AND TOLERANCES PER ASME Y14.5M-1994.
2. CONTROLLING DIMENSION: INCH
3. DIMENSION H IS MEASURED .030 INCH (0.762 MM) AWAY FROM PACKAGE BODY.
4. RECOMMENDED BOLT CENTER DIMENSION OF 1.52 INCH (38.61 MM) BASED ON M3 SCREW.

DIM	INCH		MILLIMETER		DIM	INCH		MILLIMETER	
	MIN	MAX	MIN	MAX		MIN	MAX	MIN	MAX
AA	1.615	1.625	41.02	41.28	N	1.218	1.242	30.94	31.55
BB	.395	.405	10.03	10.29	Q	.120	.130	3.05	3.30
CC	.170	.190	4.32	4.83	R	.355	.365	9.02	9.27
D	.455	.465	11.56	11.81	S	.365	.375	9.27	9.53
E	.062	.066	1.57	1.68					
F	.004	.007	0.10	0.18					
G	1.400 BSC		35.56 BSC		aaa	.013		0.33	
H	.082	.090	2.08	2.29	bbb	.010		0.25	
K	.117	.137	2.97	3.48	ccc	.020		0.51	
L	.540 BSC		13.72 BSC						
M	1.219	1.241	30.96	31.52					

© FREESCALE SEMICONDUCTOR, INC. ALL RIGHTS RESERVED.		MECHANICAL OUTLINE		PRINT VERSION NOT TO SCALE	
TITLE:			DOCUMENT NO: 98ASB16977C		REV: F
NI-1230-4H			STANDARD: NON-JEDEC		
			28 FEB 2013		

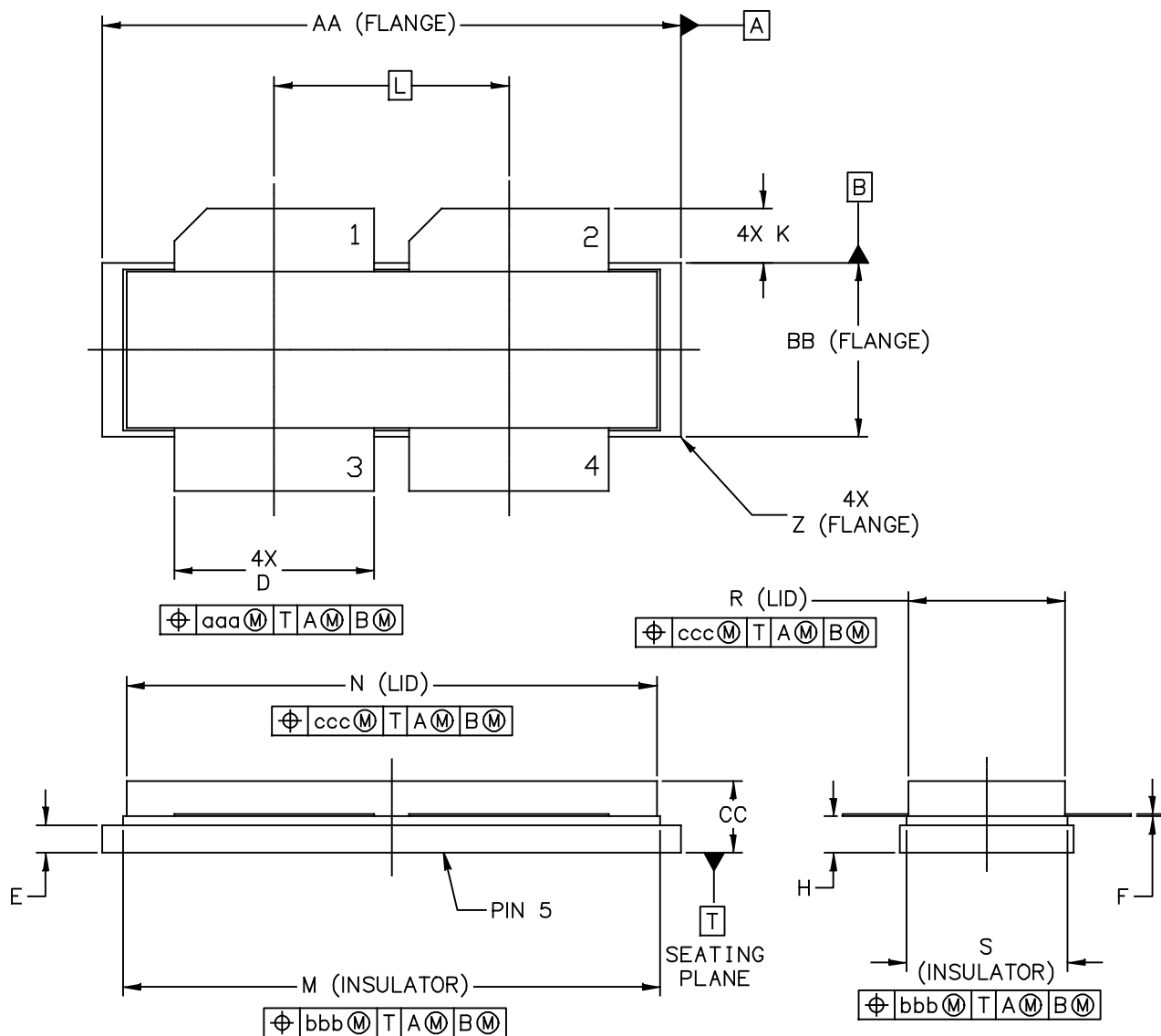

© FREESCALE SEMICONDUCTOR, INC. ALL RIGHTS RESERVED.	MECHANICAL OUTLINE	PRINT VERSION NOT TO SCALE
TITLE:  NI-1230-4S	DOCUMENT NO: 98ARB18247C	REV: G
	STANDARD: NON-JEDEC	
	01 MAR 2013	

NOTES:

1. INTERPRET DIMENSIONS AND TOLERANCES PER ASME Y14.5M–1994.
2. CONTROLLING DIMENSION: INCH
3. DIMENSION H IS MEASURED .030 INCH (0.762 MM) AWAY FROM PACKAGE BODY

DIM	INCHES		MILLIMETERS		DIM	INCHES		MILLIMETERS	
	MIN	MAX	MIN	MAX		MIN	MAX	MIN	MAX
AA	1.265	1.275	32.13	32.39	R	.355	.365	9.02	9.27
BB	.395	.405	10.03	10.29	S	.365	.375	9.27	9.53
CC	.170	.190	4.32	4.83	Z	R.000	R.040	R0.00	R1.02
D	.455	.465	11.56	11.81					
E	.062	.066	1.57	1.68	aaa	.013		0.33	
F	.004	.007	0.10	0.18	bbb	.010		0.25	
H	.082	.090	2.08	2.29	ccc	.020		0.51	
K	.117	.137	2.97	3.48					
L	.540 BSC		13.72 BSC						
M	1.219	1.241	30.96	31.52					
N	1.218	1.242	30.94	31.55					
© FREESCALE SEMICONDUCTOR, INC. ALL RIGHTS RESERVED.			MECHANICAL OUTLINE			PRINT VERSION NOT TO SCALE			
TITLE:					DOCUMENT NO: 98ARB18247C		REV: G		
NI-1230-4S					STANDARD: NON-JEDEC				
					01 MAR 2013				

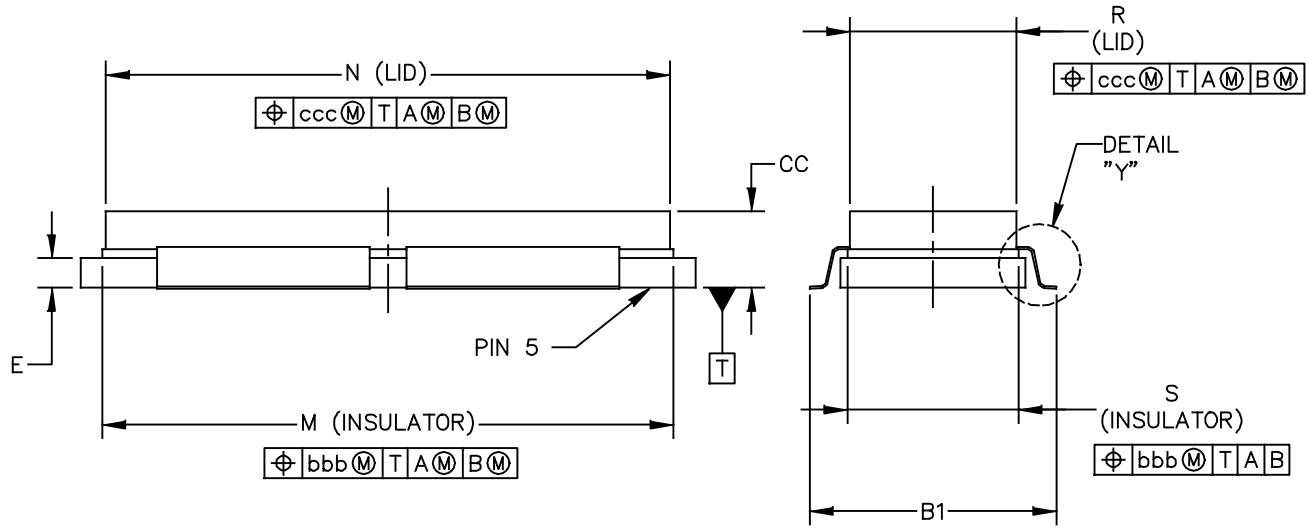
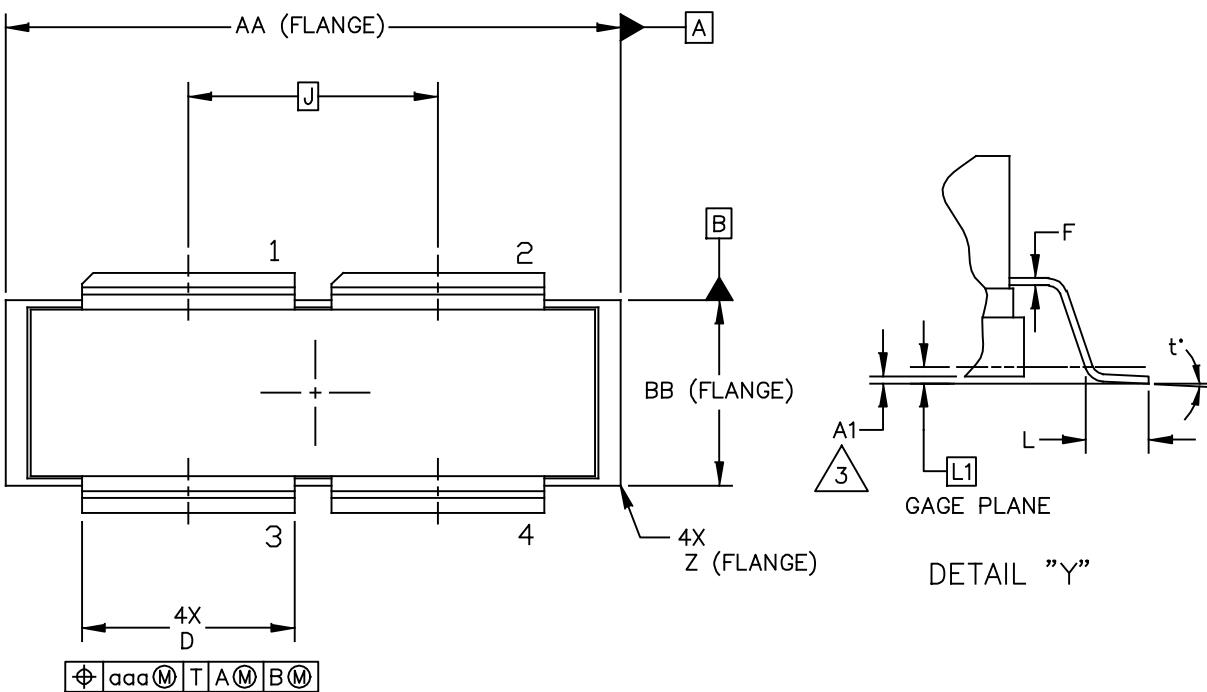

© FREESCALE SEMICONDUCTOR, INC. ALL RIGHTS RESERVED.	MECHANICAL OUTLINE	PRINT VERSION NOT TO SCALE
TITLE:  NI-1230-4S GULL	DOCUMENT NO: 98ASA00459D	REV: A
	STANDARD: NON-JEDEC	
	07 MAR 2013	

NOTES:

1. INTERPRET DIMENSIONS AND TOLERANCES PER ASME Y14.5M-1994.
2. CONTROLLING DIMENSION: INCH

3. DIMENSION A1 IS MEASURED WITH REFERENCE TO DATUM T. THE POSITIVE VALUE IMPLIES THAT THE PACKAGE BOTTOM IS HIGHER THAN THE LEAD BOTTOM.

DIM	INCHES		MILLIMETERS		DIM	INCHES		MILLIMETERS	
	MIN	MAX	MIN	MAX		MIN	MAX	MIN	MAX
AA	1.265	1.275	32.13	32.39	R	.355	.365	9.02	9.27
A1	-.001	.011	-0.03	0.28	S	.365	.375	9.27	9.53
BB	.395	.405	10.03	10.29	Z	R.000	R.040	R0.00	R1.02
B1	.564	.574	14.32	14.58	t*	0*	8*	0*	8*
CC	.170	.190	4.32	4.83					
D	.455	.465	11.56	11.81	aaa	.013		0.33	
E	.062	.066	1.57	1.68	bbb	.010		0.25	
F	.004	.007	0.10	0.18	ccc	.020		0.51	
J	.540 BSC		13.72 BSC						
L	.038	.046	0.97	1.17					
L1	.01 BSC		0.25 BSC						
M	1.219	1.241	30.96	31.52					
N	1.218	1.242	30.94	31.55					
© FREESCALE SEMICONDUCTOR, INC. ALL RIGHTS RESERVED.			MECHANICAL OUTLINE			PRINT VERSION NOT TO SCALE			
TITLE:					DOCUMENT NO: 98ASA00459D      REV: A				
NI-1230-4S GULL					STANDARD: NON-JEDEC				
					07 MAR 2013				

## PRODUCT DOCUMENTATION AND SOFTWARE

Refer to the following documents and software to aid your design process.

### Application Notes

- AN1955: Thermal Measurement Methodology of RF Power Amplifiers

### Engineering Bulletins

- EB212: Using Data Sheet Impedances for RF LDMOS Devices

### Software

- Electromigration MTTF Calculator
- RF High Power Model
- .s2p File

For Software, do a Part Number search at <http://www.freescale.com>, and select the “Part Number” link. Go to the Software & Tools tab on the part’s Product Summary page to download the respective tool.

## REVISION HISTORY

The following table summarizes revisions to this document.

Revision	Date	Description
0	Nov. 2010	<ul style="list-style-type: none"> <li>• Initial Release of Data Sheet</li> </ul>
1	Jan. 2011	<ul style="list-style-type: none"> <li>• Fig. 1, Pin Connections, corrected pin 4 label from <math>RF_{out}/V_{GS}</math> to <math>RF_{in}/V_{GS}</math>, p. 1</li> </ul>
2	May 2012	<ul style="list-style-type: none"> <li>• Added Application Circuits Typical Performance table, p. 1</li> <li>• Capable of Handling VSWR bullet: corrected 1250 Peak Output Power value to 1500 and converted to table, pp. 1, 3</li> <li>• Table 1, Max Ratings: final DC test specification for Drain–Source Voltage changed from +125 to +133 Vdc, p. 2</li> <li>• Table 3, ESD Protection Characteristics: added the device’s ESD passing level as applicable to each ESD class, p. 2</li> <li>• Table 4, Off Characteristics: final DC test specification for Drain–Source Breakdown Voltage minimum value changed from 125 to 133 Vdc, p. 2</li> <li>• Table 4, On Characteristics: added Forward Transconductance, p. 2</li> <li>• Fig. 10, MTTF versus Junction Temperature – CW: MTTF end temperature on graph changed to match maximum operating junction temperature, p. 7</li> <li>• Added Fig. 12, Source and Load Impedances Optimized for IRL, Power and Efficiency — Push–pull, p. 8</li> <li>• Added Fig. 13, 87.5–108 MHz FM Broadcast Reference Circuit Component Layout, p. 9</li> <li>• Added Table 9, 87.5–108 MHz FM Broadcast Reference Circuit Component Designations and Values, p. 9</li> <li>• Added Fig. 14, 87.5–108 MHz FM Broadband Reference Circuit Schematic, p. 10</li> <li>• Added Fig. 15, Power Gain and Drain Efficiency versus Output Power (87.5–108 MHz), p. 11</li> <li>• Added Fig. 16, Series Equivalent 87.5–108 MHz FM Broadcast Reference Circuit Source and Load Impedance, p. 11</li> <li>• Added Fig. 17, 144–148 MHz Reference Circuit Component Layout, p. 12</li> <li>• Added Table 9, 144–148 MHz Reference Circuit Component Designations and Values, p. 12</li> <li>• Added Fig. 18, 144–148 MHz Reference Circuit Schematic, p. 13</li> <li>• Added Fig. 19, Series Equivalent 144–148 MHz Reference Circuit Source and Load Impedance, p. 14</li> <li>• Added Fig. 20, Power Gain and Drain Efficiency versus Output Power (144–148 MHz), p. 14</li> <li>• Added Fig. 21, Intermodulation Distortion Products versus Output Power (144–148 MHz), p. 14</li> <li>• Added Fig. 22, 144 MHz Harmonics @ 1 kW, p. 15</li> </ul>
3	Oct. 2012	<ul style="list-style-type: none"> <li>• Added part number MRFE6VP61K25GSR5, p. 1</li> <li>• Added 2282-02 (NI-1230S-4 Gull) package isometric, p. 1, and Mechanical Outline, p. 20, 21</li> </ul>
4	Mar. 2013	<ul style="list-style-type: none"> <li>• MRFE6VP61K25HR6 tape and reel option replaced with MRF6VP61K25HR5 per PCN15551.</li> <li>• Replaced Case Outline 98ASB16977C, Issue E with Issue F, p. 16, 17. Changed dimension C from 0.150”–0.200” to CC 0.170”–0.190”.</li> <li>• Replaced Case Outline 98ARB18247C, Issue F with Issue G, p. 18, 19. Changed dimension C from 0.150”–0.200” to CC 0.170”–0.190”. Added minimum Z dimension R0.00”.</li> <li>• Replaced Case Outline 98ASA00459D, Issue O with Issue A, p. 20, 21. Changed dimension C from 0.150”–0.200” to CC 0.170”–0.190”. Corrected positional tolerance for dimension S.</li> </ul>
4.1	Mar. 2014	<ul style="list-style-type: none"> <li>• MRFE6VP61K25HR5 part added to data sheet device box, p. 1</li> <li>• MRFE6VP61K25HSR6 tape and reel option replaced with MRFE6VP61K25HSR5 per PCN15551. (Note: this copy updates the copy from Rev. 4 Revision History to accurately reflect the part number replacement in this data sheet as described in PCN15551.)</li> </ul>

**MRFE6VP61K25HR6 MRFE6VP61K25HR5 MRFE6VP61K25HSR5 MRFE6VP61K25GSR5**

### ***How to Reach Us:***

**Home Page:**  
[freescale.com](http://freescale.com)

**Web Support:**  
[freescale.com/support](http://freescale.com/support)

Information in this document is provided solely to enable system and software implementers to use Freescale products. There are no express or implied copyright licenses granted hereunder to design or fabricate any integrated circuits based on the information in this document.

Freescale reserves the right to make changes without further notice to any products herein. Freescale makes no warranty, representation, or guarantee regarding the suitability of its products for any particular purpose, nor does Freescale assume any liability arising out of the application or use of any product or circuit, and specifically disclaims any and all liability, including without limitation consequential or incidental damages. "Typical" parameters that may be provided in Freescale data sheets and/or specifications can and do vary in different applications, and actual performance may vary over time. All operating parameters, including "typicals," must be validated for each customer application by customer's technical experts. Freescale does not convey any license under its patent rights nor the rights of others. Freescale sells products pursuant to standard terms and conditions of sale, which can be found at the following address: [freescale.com/SalesTermsandConditions](http://freescale.com/SalesTermsandConditions).

Freescale and the Freescale logo are trademarks of Freescale Semiconductor, Inc., Reg. U.S. Pat. & Tm. Off. All other product or service names are the property of their respective owners.

© 2014 Freescale Semiconductor, Inc.