

# High Frequency Ceramic Solutions

**Miniature 2.4GHz Impedance Matched FCC / ETSI Compliant Low Pass Filter:**  
**Optimized for Nordic's Chipset nRF52840-QIAA**

**P/N 2450FM07B0037**

Detail Specification: 4/8/2020

Page 1 of 4

AEC-Q200 qualified component available, contact us at: <https://www.johansontechnology.com/ask-a-question>

## General Specifications

<b>Part Number</b>	2450FM07B0037
<b>Frequency (MHz)</b>	2400 - 2500
<b>Insertion loss (dB)</b>	0.4 typ. (0.8 max.)
<b>Return Loss (dB)</b>	10 min.
<b>Input Impedance (Terminal Towards Chipset)</b>	Impedance matched to Nordic Semiconductor nRF52840-QIAA
<b>Output Impedance</b>	50Ω
<b>Power Capacity</b>	3W max. (CW)

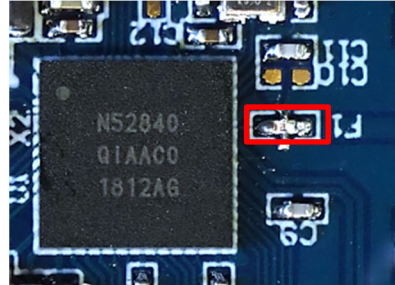

For the Full App Note and Layout Files, go to:  
<https://www.johansontechnology.com/nordic>

<b>Attenuation (dB)</b>		<b>Reel Quantity</b>	10,000 pcs/reel
4800 - 5000MHz	23 min.	<b>Operating Temperature</b>	-40 to +85°C
7200 - 7500MHz	31 min.	<b>Recommended Storage Conditions for unused T&amp;R product</b>	+5 to +35°C
9600 - 10000MHz	30 min.		Humidity: 45-75%RH
12000 - 12500MHz	25 min.		18 months max.

## Part Number Explanation

P/N Suffix	Packaging Style	Bulk	Suffix = S	E.g. 2450FM07B0037S
		T & R	Suffix = T	E.g. 2450FM07B0037T
	Termination Style	100% Tin	Suffix = None	E.g. 2450FM07B0037(T or S)

## Mechanical Dimensions

	In	mm
<b>L</b>	0.039 ± 0.002	1.00 ± 0.05
<b>W</b>	0.020 ± 0.002	0.50 ± 0.05
<b>T</b>	0.016 max.	0.40 max.
<b>a</b>	0.007 ± 0.004	0.18 ± 0.10
<b>b</b>	0.010 ± 0.004	0.25 ± 0.10

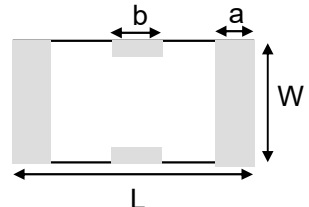
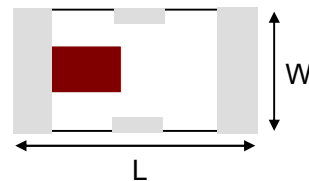
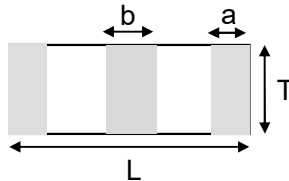

## Terminal Configuration

No.	Function
1	IN (To the nRF52)
2	GND
3	OUT (To Antenna or PA)
4	GND

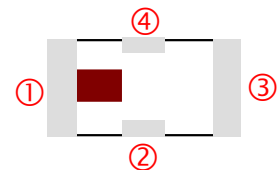

Johanson Technology, Inc. reserves the right to make design changes without notice.

All sales are subject to Johanson Technology, Inc. terms and conditions.



<https://www.johansontechnology.com>

4001 Calle Tecate • Camarillo, CA 93012, USA • TEL +1.805.389.1166

Ver. 1.2

2020 Johanson Technology, Inc. All Rights Reserved

# High Frequency Ceramic Solutions

Miniature 2.4GHz Impedance Matched FCC / ETSI Compliant Low Pass Filter: Optimized for Nordic's Chipset nRF52840-QIAA P/N 2450FM07B0037



Detail Specification: 4/8/2020

Page 2 of 4

## Mounting Pad Dimensions

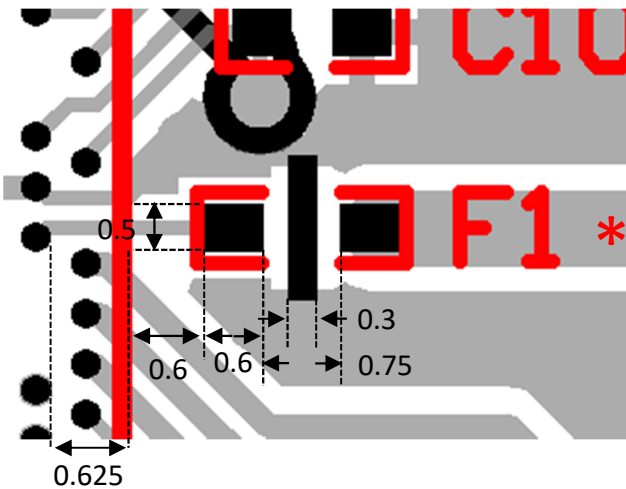
Units in mm



-  Solder Resist
-  Land
-  Through-hole ( $\phi$  0.20)

\*Line width should be designed to match 50 $\Omega$  characteristic impedance, depending on PCB material and thickness.

Do you need the layout files of the above? Go to: <https://www.johansontechnology.com/nordic> or send us a message to review your layout at: <https://www.johansontechnology.com/ask-a-question>

## Measurement Schematic

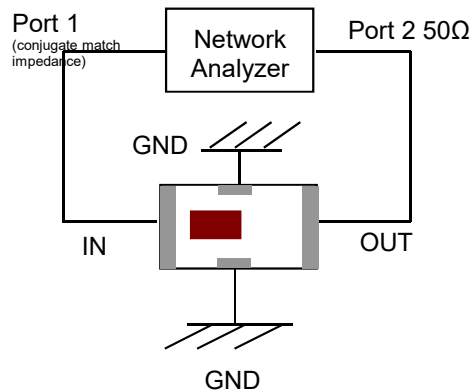

Port 1: Filter IN (marking side)  
Port 2: Filter OUT

Johanson Technology, Inc. reserves the right to make design changes without notice.

All sales are subject to Johanson Technology, Inc. terms and conditions.



Ver. 1.2

<https://www.johansontechnology.com>

4001 Calle Tecate • Camarillo, CA 93012, USA • TEL +1.805.389.1166

2020 Johanson Technology, Inc. All Rights Reserved

# High Frequency Ceramic Solutions

Miniature 2.4GHz Impedance Matched FCC / ETSI Compliant Low Pass Filter: Optimized for Nordic's Chipset nRF52840-QIAA P/N 2450FM07B0037

Detail Specification: 4/8/2020

Page 3 of 4

## Typical Electrical Characteristics (T=25°C)

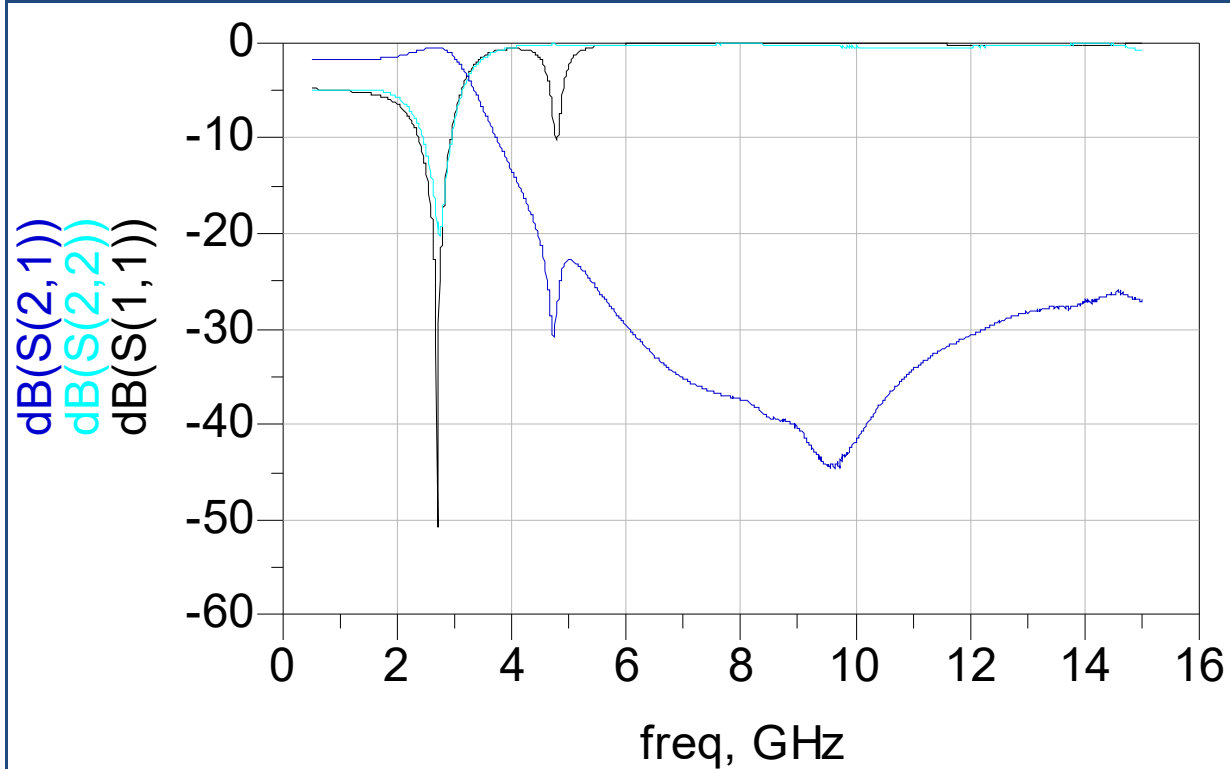

If you would like recommendation on a mini 2.4G embedded antenna, free layout verification, reference design files (gerbers, schematic, etc) or s-parameter files, please contact us at:

<https://www.johansontechnology.com/ask-a-question>

Johanson Technology, Inc. reserves the right to make design changes without notice.

All sales are subject to Johanson Technology, Inc. terms and conditions.



Ver. 1.2

<https://www.johansontechnology.com>

4001 Calle Tecate • Camarillo, CA 93012, USA • TEL +1.805.389.1166

2020 Johanson Technology, Inc. All Rights Reserved

# High Frequency Ceramic Solutions

Miniature 2.4GHz Impedance Matched FCC / ETSI Compliant Low Pass Filter: Optimized for Nordic's Chipset nRF52840-QIAA P/N 2450FM07B0037

Detail Specification: 4/8/2020

Page 4 of 4

## Application Notes, Layout Files, and more

<https://www.johansontechnology.com/nordic>

## Packaging information

<https://www.johansontechnology.com/tape-reel-packaging>

## Soldering Information

<https://www.johansontechnology.com/ipcsoldering-profile>

## MSL Info

<https://www.johansontechnology.com/msl-rating>

## Recommended Storage Condition and Max Shelf Life

<https://www.johansontechnology.com/recommended-storage-conditions>

## RoHS Compliance

<https://www.johansontechnology.com/technical-notes/rohs-compliance>

## Antenna layout and tuning techniques

<https://www.johansontechnology.com/tuning>

## Antenna layout review, tuning, and characterization services

<https://www.johansontechnology.com/ipc-antenna-services>

Johanson uses 6/6 RoHS Green Low-Temperature-Co-fired-Ceramic (LTCC) integrated passive technology in a 4-pin (Sn plated) monolithic structure. This component is 100% RF Tested, making it a more reliable system, impedance controlled environment, consistent-guaranteed RF performance in a very small RF front end-solution compared to the L/C discrete solution.



Johanson Technology, Inc. reserves the right to make design changes without notice.

All sales are subject to Johanson Technology, Inc. terms and conditions.



Ver. 1.2

<https://www.johansontechnology.com>

4001 Calle Tecate • Camarillo, CA 93012, USA • TEL +1.805.389.1166

2020 Johanson Technology, Inc. All Rights Reserved