

249 SERIES FOR 3/8" MOUNTING HOLE

PART NUMBER*	COLOR	VOLTAGE	mA	SERIES	
				OHMS	FIG
249-7841-1431-574	RED	105-125 AC-DC	0.7	100K	1
249-7841-1433-574	AMBER	105-125 AC-DC	0.7	100K	1
249-7841-1437-574	CLEAR	105-125 AC-DC	0.7	100K	1
249-7866-1431-514	RED	110-125 AC-DC	1.9	22K	1
249-7866-1433-514	AMBER	110-125 AC-DC	1.9	22K	1
249-7866-1437-514	CLEAR	110-125 AC-DC	1.9	22K	1

Material & Finish: Housing - Black Anodized Aluminum. Cap - High Impact Plastic

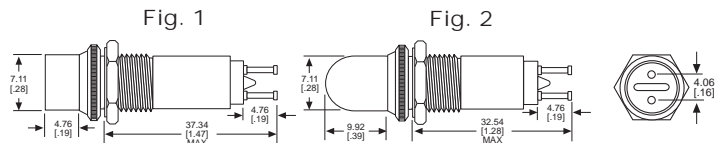

***PART NUMBER ORDERING CODE**
249 - 7841 - xx3x - 574
249 - 7866 - xx3x - 514

Series: 249
 Lens Shape: 14 - Fig 1 = Cylindrical, 09 - Fig 2 = Stovepipe

507 SERIES CARTRIDGES FOR HOLDERS & CLIPS • 25,000 LIFE HOURS

PART NUMBER*	COLOR	VOLTAGE	mA	SERIES	
				OHMS	FIG
507-4537-1431-640	RED	105-125 AC-DC	0.3	100K	3
507-4537-1433-640	AMBER	105-125 AC-DC	0.3	100K	3
507-4537-1435-640	WHITE	105-125 AC-DC	0.3	100K	3
507-4537-1437-640	CLEAR	105-125 AC-DC	0.3	100K	3
507-4538-1431-630	RED	110-125 AC-DC	1.2	47K	3
507-4538-1433-630	AMBER	110-125 AC-DC	1.2	47K	3
507-4538-1435-630	WHITE	110-125 AC-DC	1.2	47K	3
507-4538-1437-630	CLEAR	110-125 AC-DC	1.2	47K	3

Material & Finish: Housing - Clear Anodized Aluminum. Cap - High Impact Plastic

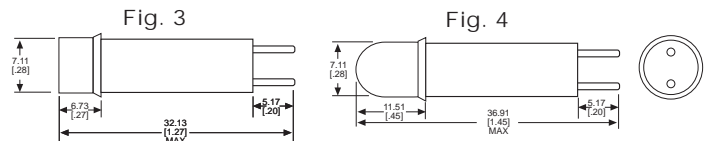

***PART NUMBER ORDERING CODE**
507 - 4537 - xx3x - 640
507 - 4538 - xx3x - 630

Series: 507
 Lens Shape: 14 - Fig 3 = Cylindrical, 09 - Fig 4 = Stovepipe

250 & 508 SERIES HOLDERS FOR 3/8" MOUNTING HOLE

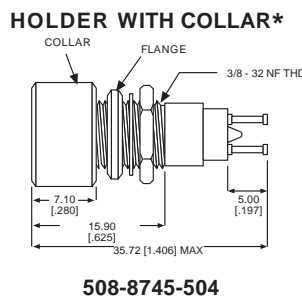
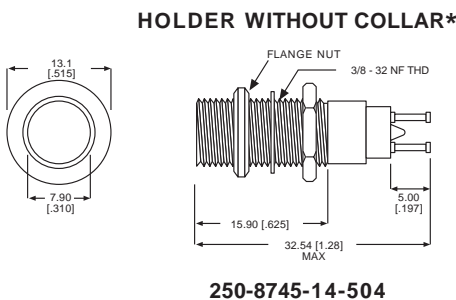

***PART NUMBER ORDERING CODE**
250 - xx45 - 14 - 504
508 - xx45 - 504

Series: 250/508
 Terminal Type: 87 = Turret Terminals, 74 = Solder Blade (Not Shown), 75 = Solder Cups (Not Shown)

250 Series Caps for use with 507 cylindrical cartridges. (Fig. 3)

CAP PART NO.	COLOR	FIG
250-3531-500	RED	5
250-3533-500	AMBER	5
250-3535-500	WHITE	5
250-3537-500	CLEAR	5

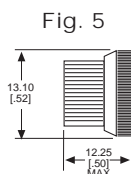

250 Series Caps for use with 507 stovepipe cartridges. (Fig. 4)

CAP PART NO.	COLOR	FIG
250-1631-500	RED	6
250-1633-500	AMBER	6
250-1635-500	WHITE	6
250-1637-500	CLEAR	6

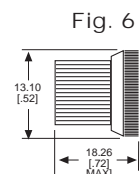

Material & Finish: Holders - Black Anodized Aluminum, Cap - Polycarbonate Fig. 5, High Impact Plastic Fig. 6, Cartridge - Clear Anodized Aluminum

515 SERIES CONNECTORS & SPEED CLIPS FOR 9/32" MOUNTING HOLE

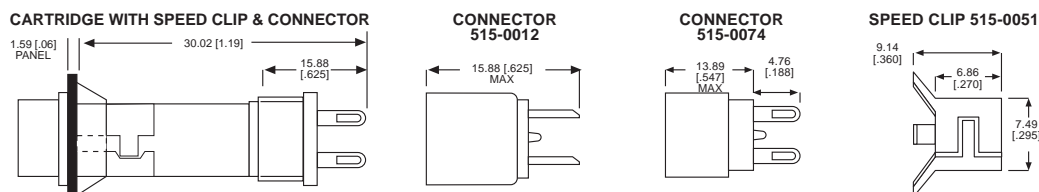

Green and Blue Lens Caps Not Available for Neon Indicators
 Dimensions in mm [inches]