

IF Series

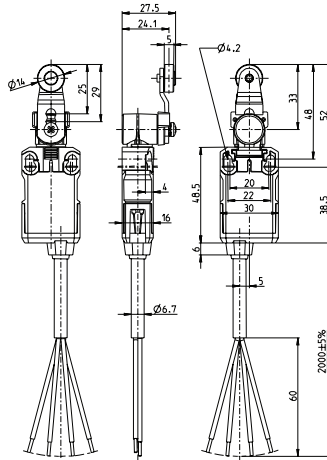

AH



IWF

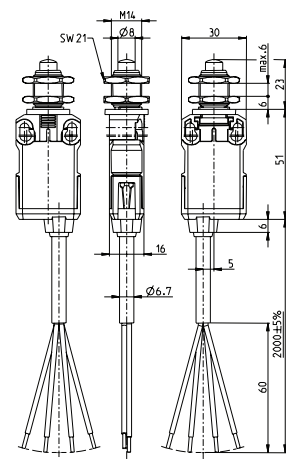

Switching Operation

1 NC / 1 NO Contacts

Slow Action

Snap Action

Slow Action

Snap Action

608.9135.003
IF-U1Z AH

608.9185.008
IF-SU1Z AH

608.9102.004
IF-U1Z IWF

608.9152.009
IF-SU1Z IWF

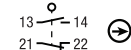
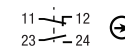
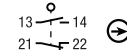
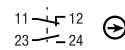

2 NC Contacts

608.9835.013
IF-A2Z AH

608.9885.041
IF-SA2Z AH

608.9802.014
IF-A2Z IWF

608.9852.043
IF-SA2Z IWF

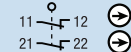
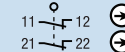
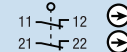
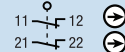

2 NO Contacts

-

-

-

-

1 NC / 1 NO Contacts Overlapping

-

-

-

-

Technical Information

	Slow Action	Snap Action
Maximum Switching Voltage	240V	240V
Maximum Switching Amperage	10A	10A
B10d	6 Million	6 Million
Mechanical Service Life	3 x 10 ⁶	3 x 10 ⁶
Switching Frequency	≤ 30/min	≤ 30/min
Operating Temperature	-30 °C to +80 °C	-30 °C to +80 °C
Protection Rating	IP67	IP67
Utilization Category	AC-15, Ue/Ue 240V 3A	AC-15, Ue/Ue 240V 3A
Rate Insulation Voltage	240VAC	240VAC

Approvals



Special features/variants

- Actuator can be turned in steps of 90°

Slow Action

Snap Action

	Slow Action	Snap Action
Maximum Switching Voltage	240V	240V
Maximum Switching Amperage	10A	10A
B10d	6 Million	6 Million
Mechanical Service Life	3 x 10 ⁶	3 x 10 ⁶
Switching Frequency	≤ 30/min	≤ 30/min
Operating Temperature	-30 °C to +80 °C	-30 °C to +80 °C
Protection Rating	IP67	IP67
Utilization Category	AC-15, Ue/Ue 240V 3A	AC-15, Ue/Ue 240V 3A
Rate Insulation Voltage	240VAC	240VAC



Special features/variants

- Front mounting

Drawing dimensions in mm