

Features

- 1.4 dB Noise Figure
- 35 dBm Output IP₃
- Single +3 V Bias
- Lead-Free SC70 6-Lead (SOT-363) Package
- Halogen-Free “Green” Mold Compound
- RoHS* Compliant and 260°C Reflow Compatible

Description

The MAAL-009053 broadband gain block is a GaAs MMIC amplifier in a lead-free SC70-6LD (SOT-363) surface mount plastic package. The topology is a monolithic single stage self-biased design featuring a convenient 50 Ω input / output impedance that minimizes the number of external components.

The MAAL-009053 is fabricated using a pHEMT process to help realize the complementary high IP3 and low NF. This process features full passivation for performance and reliability.

Ordering Information¹

Part Number	Package
MAAL-009053-000000	Bulk Packaging
MAAL-009053-TR3000	3000 piece reel

1. Reference Application Note M513 for reel size information.

Functional Schematic

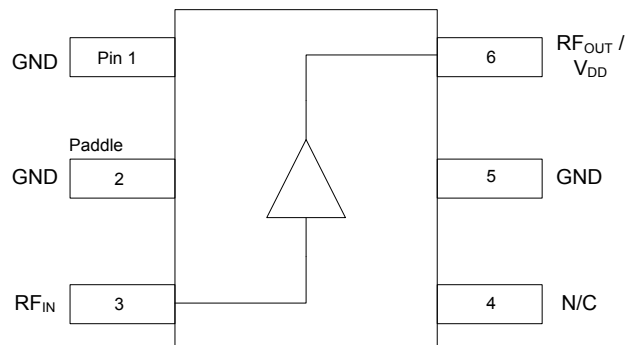

Pin Configuration²

Pin No.	Function	Description
1	GND	Ground
2	GND	Ground
3	RF _{IN}	RF Input
4	N/C	No Connection
5	GND	Ground
6 ³	RF _{OUT} /V _{DD}	RF Output / Drain Voltage

2. MACOM recommends connecting unused package pins to ground.
3. Series inductor and decoupling capacitor recommended on pin 6.

* Restrictions on Hazardous Substances, European Union Directive 2011/65/EU.

Electrical Specifications: $T_A = +25^\circ\text{C}$, $V_{DD} = +3\text{ V}$, $Z_0 = 50\ \Omega$

Parameter	Test Conditions	Units	Bias Voltage			
			3 Volts			5 Volts ⁸
			Min.	Typ.	Max.	Typ.
Gain	0.9 GHz 1.9 GHz	dB	— 10.4	14.0 11.0	— 13.0	14.5 11.2
Noise Figure	0.9 GHz 1.9 GHz	dB	—	1.4 1.4	— 1.8	1.5 1.5
Input Return Loss	0.9 GHz 1.9 GHz	dB	—	7 11	—	7 11
Output Return Loss	0.9 GHz 1.9 GHz	dB	—	22 20	—	26.0 18.5
Output P1dB	900 - 1900 MHz	dBm	—	18.5	—	—
Output IP ₃	900 - 1900 MHz	dBm	—	35	—	35
Current	—	mA	60	80	100	95

Absolute Maximum Ratings^{4,5}

Parameter	Absolute Maximum
Gain Compression	6 dB
Voltage	5.5 V
Junction Temperature ^{6,7}	+150°C
Operating Temperature	-40°C to +85°C
Storage Temperature	-65°C to +150°C

- Exceeding any one or combination of these limits may cause permanent damage to this device.
- MACOM does not recommend sustained operation near these survivability limits.
- Operating at nominal conditions with $T_J \leq 150^\circ\text{C}$ will ensure $\text{MTTF} > 1 \times 10^6$ hours.
- Junction Temperature (T_J) = Case Temperature (T_C) + $\Theta_{jc} \cdot (V \cdot I)$
Typical thermal resistance (Θ_{jc}) = 131°C/W
 - For $T_C = +25^\circ\text{C}$,
 $T_J = 53^\circ\text{C}$ @ 3 V, 80 mA
 - For $T_C = +85^\circ\text{C}$,
 $T_J = 113^\circ\text{C}$ @ 3 V, 80 mA

Handling Procedures

Please observe the following precautions to avoid damage:

Static Sensitivity

These electronic devices are sensitive to electrostatic discharge (ESD) and can be damaged by static electricity. Proper ESD control techniques should be used when handling these devices.

Satellite TV Amplifier 800 - 3000 MHz

Rev. V5

800 - 3000 MHz, Recommended PCB Configuration

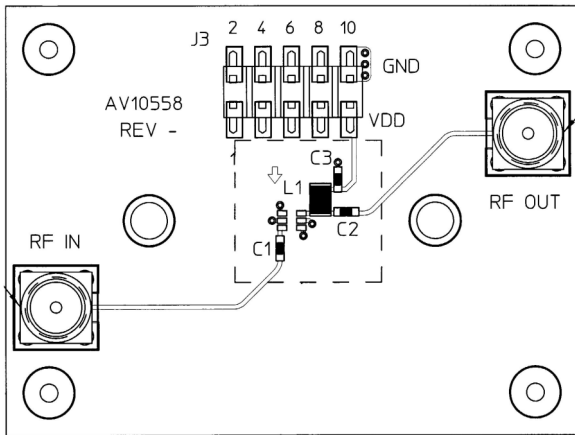

800 - 3000 MHz, Application Schematic

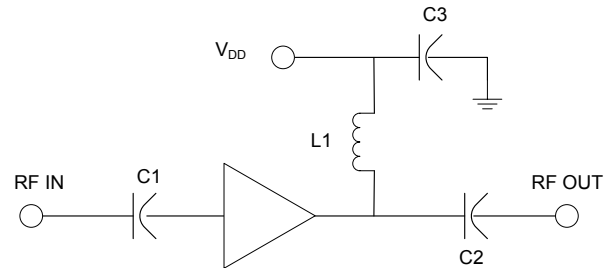

800 - 3000 MHz, Component List

Part	Value	Case Style	Purpose
C1	39 pF	0402	Input DC Block
C2	39 pF	0402	Output DC Block
C3	470 pF	0402	RF Bypass
L1	12 nH	0805	RF Choke/Tuning

Lead-Free SC-70 6-Lead (SOT-363)[†]

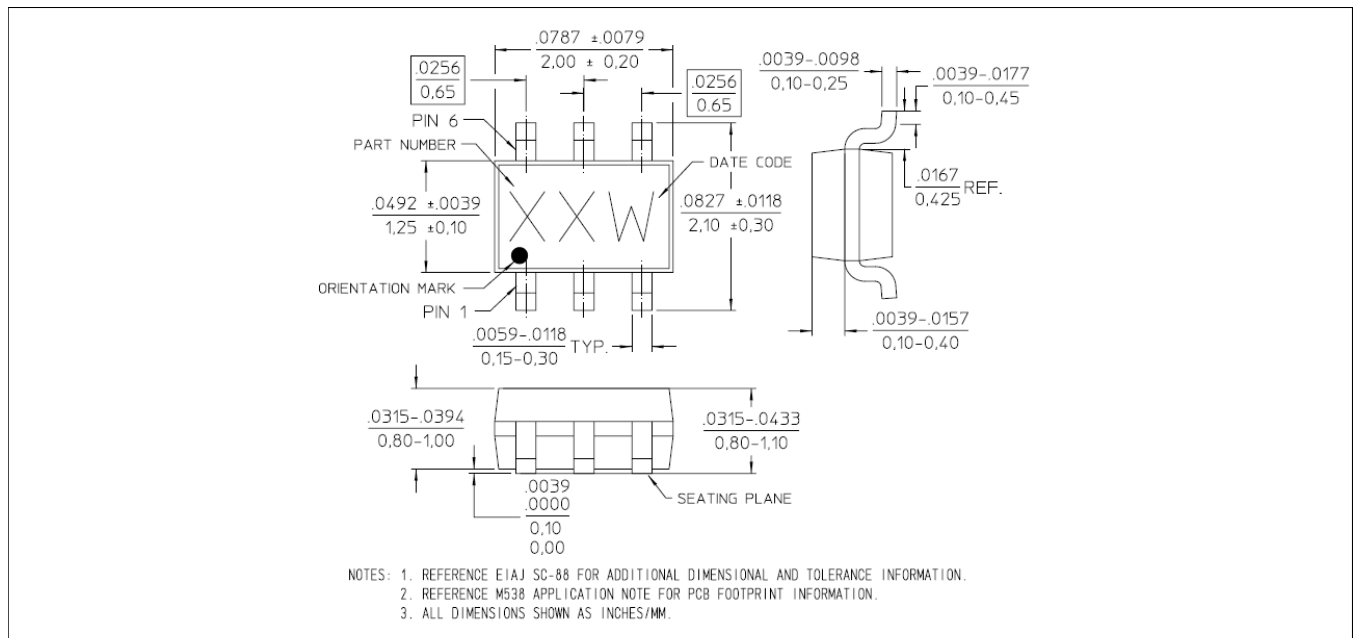

[†] Reference Application Note M538 for lead-free solder reflow recommendations.
Meets JEDEC moisture sensitivity level 1 requirements.
Plating is matte tin over copper.

Typical Performance Curves: $V_{DD} = 3\text{ V}$

Gain

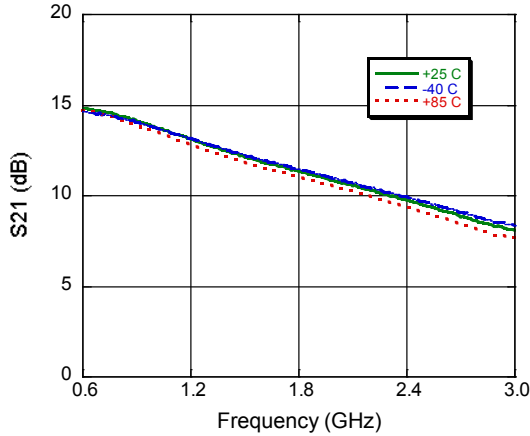

Input Return Loss

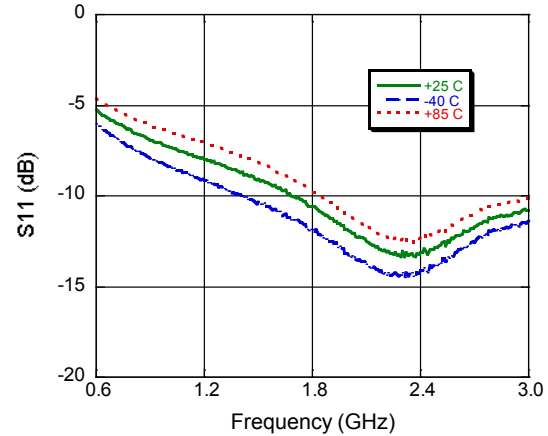

Output Return Loss

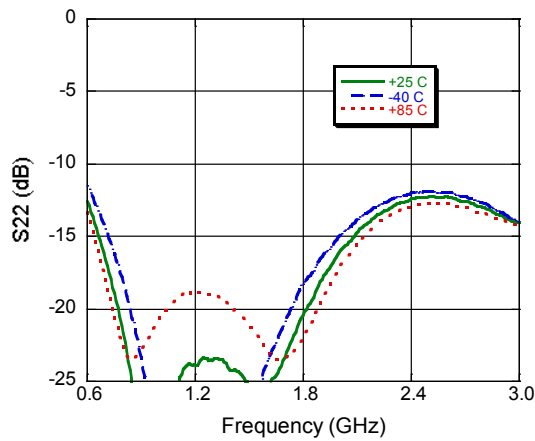

Noise Figure

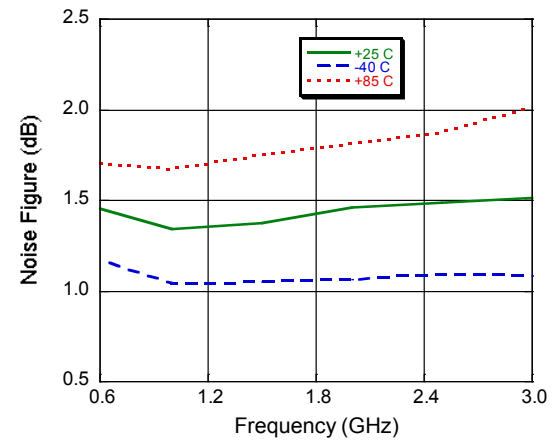

Output IP3, Input Power @ -12 dBm

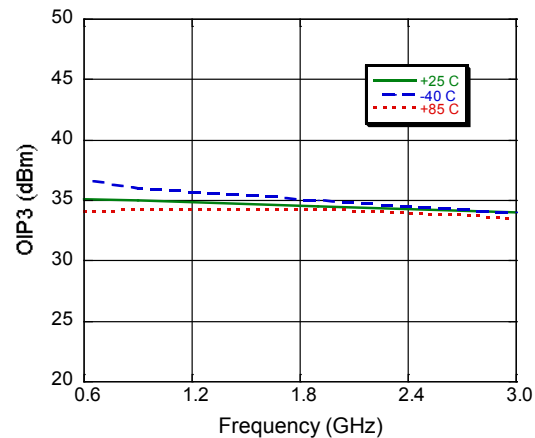

P1dB

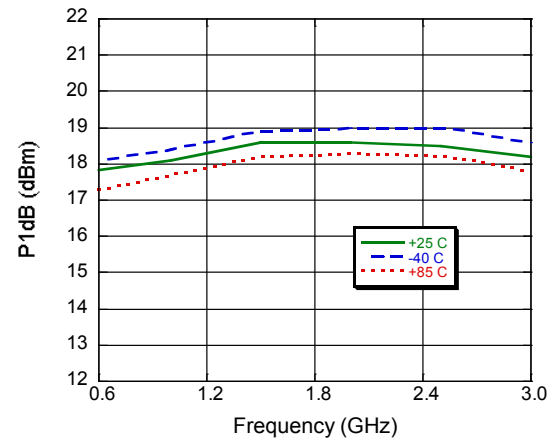

5 Volt Application Section for operation above 10 dBm output power

Application Layout Schematic @ 5 V⁸

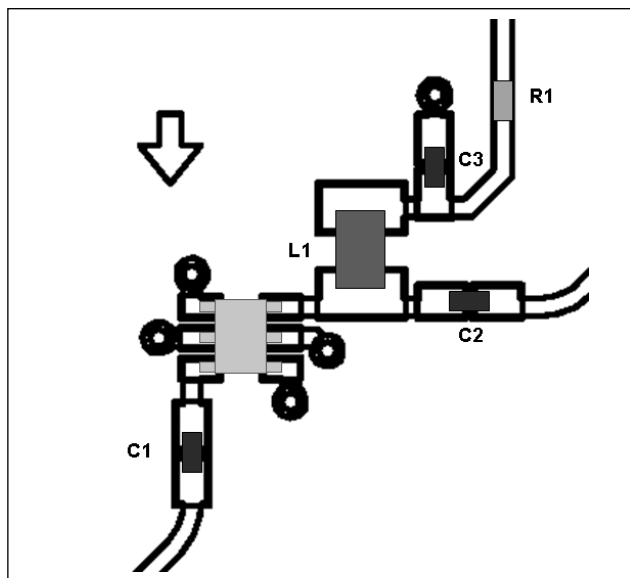

8. The addition of a 24.9 Ω series resistor on the drain line allows for 5 volt operation above 10 dBm output power, but no greater than 22 dBm of output power.

Application Schematic @ 5 V

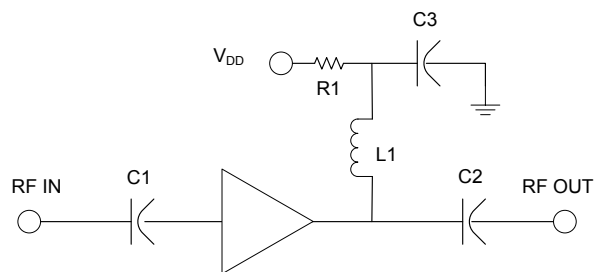

Component List @ 5 V

Part	Value	Case Style	Purpose
C1	39 pF	0402	Input DC Block
C2	39 pF	0402	Output DC Block
C3	470 pF	0402	RF Bypass
L1	12 nH	0805	RF Choke/Tuning
R1	24.9 Ω	0402	Voltage Drop

5 Volt Application Section for operation above 10 dBm output power

Typical Performance Curves: $V_{DD} = 5\text{ V}$

Gain

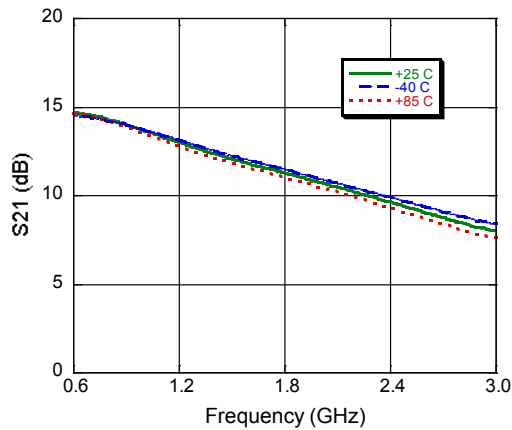

Input Return Loss

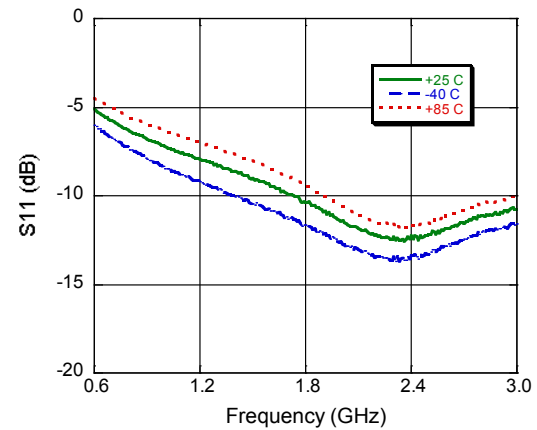

Output Return Loss

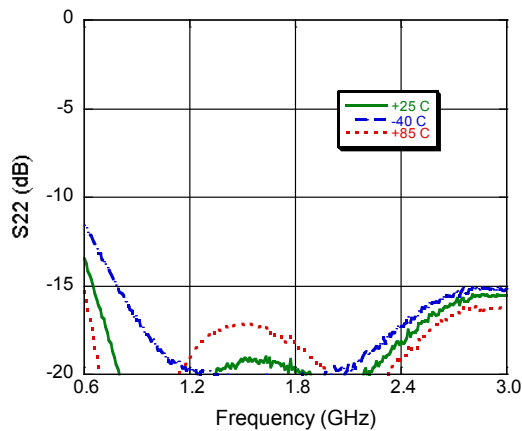

P1dB

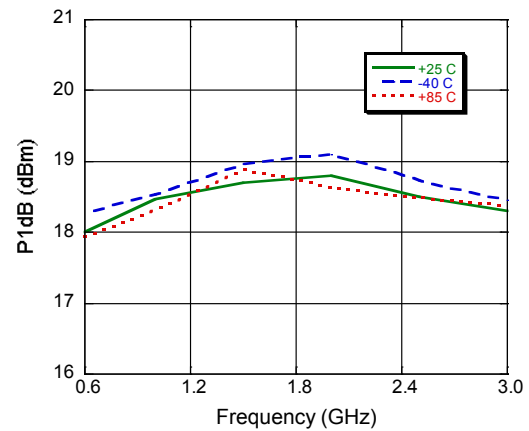

Output IP3

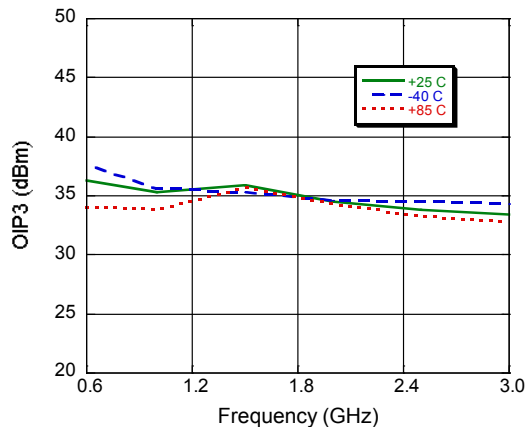

3 Volt Application Section 75 Ω Input - 50 Ω Output, 950 - 2150 MHz

950 - 2150 MHz, Recommended PCB Configuration

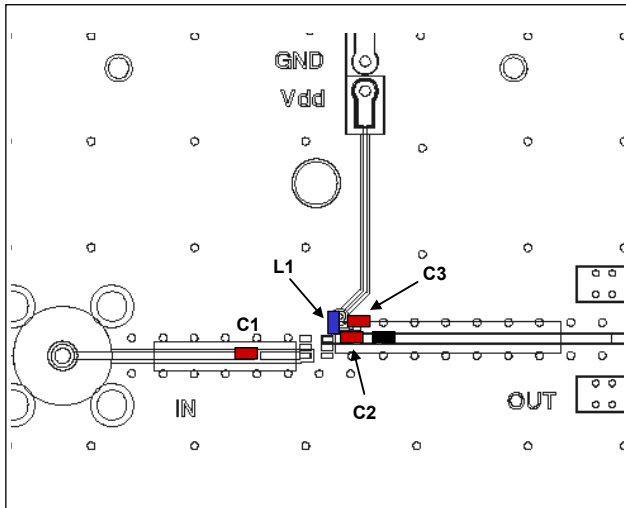

950 - 2150 MHz, Application Schematic

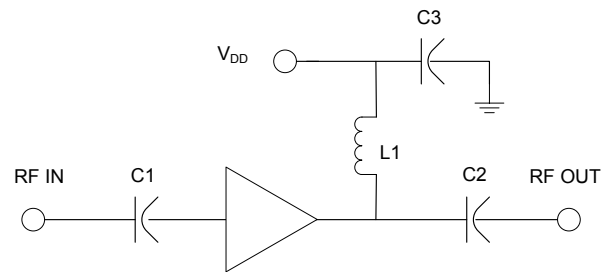

950 - 2150 MHz, Component List

Part	Value	Case Style	Purpose
C1	39 pF	0402	Input DC Block
C2	6 pF	0402	Output DC Block
C3	1000 pF	0402	RF Bypass
L1	19 nH	0402	RF Choke/Tuning

3 Volt Application Section 75 Ω Input - 50 Ω Output, 950 - 2150 MHz

Typical Performance Curves:

S-Parameters

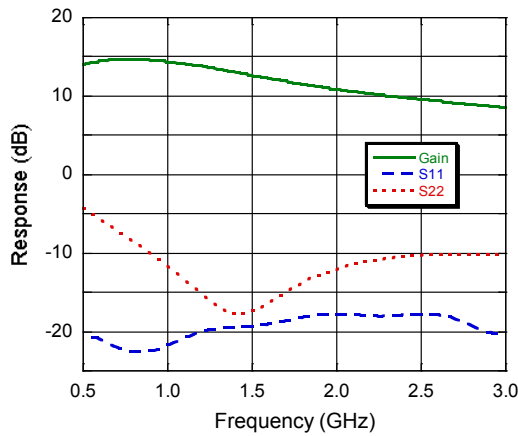

Noise

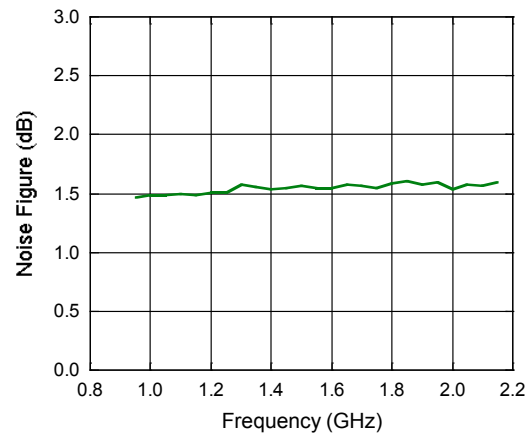

Output IP3

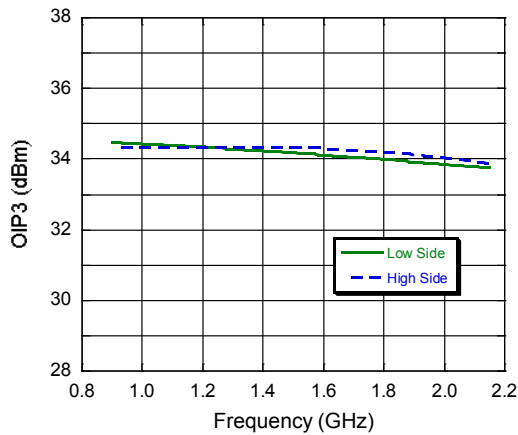

P1dB

