



Features

- Frequency Range 3000MHz to 3800MHz
- Full Internal Matching and No External Bias Inductors
- 6-Bit Digital Step Attenuator
- SPI Serial Control Programming
- Max Gain = 38dB at 3500MHz
- Gain Control Range = 31.5dB (0.5dB Step Size)
- High OIP3/P1dB = +40.5/30dBm Type
- Single +5V Supply
- Small 28-Pin, 6.0mm x 6.0mm, MCM
- Power-up Programming

Applications

- Cellular, 3G Infrastructure
- WiBro, WiMax, LTE
- Microwave Radio
- High Linearity Power Control

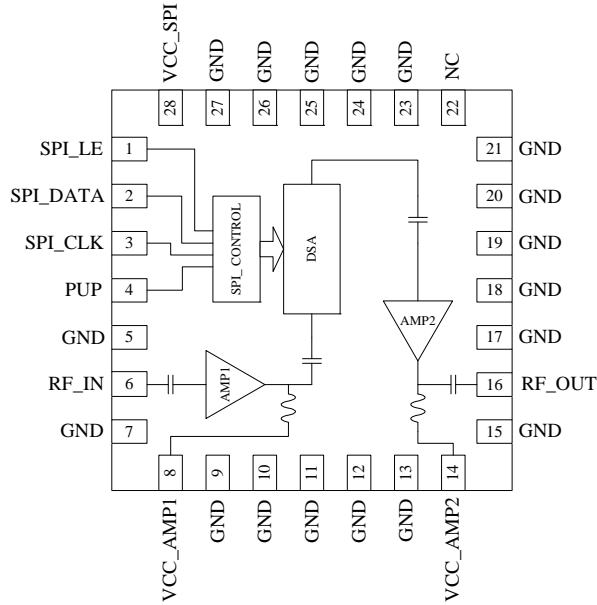

Functional Block Diagram

Product Description

RFMD's RFDA3016 is a digital controlled variable gain amplifier featuring high linearity over the entire gain control range with noise figure less than 5.0dB in its maximum gain state. The gain of the 6-bit digital step attenuator is programmed with a serial mode control interface (SPI). The RFDA3016 is packaged in a small 6.0mm x 6.0mm leadless laminate MCM, which contains plated through thermal vias for ultra-low thermal resistance. This module is easy to use with no external matching components required.

Ordering Information

RFDA3016SQ	Sample bag with 25 pieces
RFDA3016SR	7" Reel with 100 pieces
RFDA3016TR13	13" Reel with 2500 pieces
RFDA3016PCK-410	3000MHz to 3800MHz PCBA with 5-piece sample bag

Absolute Maximum Ratings

Parameter	Rating	Unit
Supply Voltage	5.5	V _{DC}
DC Supply Current	1000	mA
Power Dissipation	5.5	W
Max RF Input Power for 50Ω Output Load	+24	dBm
Operating Temperature (T _{CASE})	-40 to +85	°C
Storage Temperature	-40 to +150	°C
Junction Temperature	+165*	°C
ESD Rating (HBM)	1000 (Class 1C)	V
Moisture Sensitivity Level	MSL3	

*MTTF > 1E6 hours at 165 °C junction temperature

Note: Operation of this device beyond any one of these limits may cause permanent damage.



Caution! ESD sensitive device.

Exceeding any one or a combination of the Absolute Maximum Rating conditions may cause permanent damage to the device. Extended application of Absolute Maximum Rating conditions to the device may reduce device reliability. Specified typical performance or functional operation of the device under Absolute Maximum Rating conditions is not implied.

The information in this publication is believed to be accurate and reliable. However, no responsibility is assumed by RF Micro Devices, Inc. ("RFMD") for its use, nor for any infringement of patents, or other rights of third parties, resulting from its use. No license is granted by implication or otherwise under any patent or patent rights of RFMD. RFMD reserves the right to change component circuitry, recommended application circuitry and specifications at any time without prior notice.



RFMD Green: RoHS compliant per EU Directive 2002/95/EC, halogen free per IEC 61249-2-21, < 1000ppm each of antimony trioxide in polymeric materials and red phosphorus as a flame retardant, and <2% antimony in solder.

Nominal Operating Parameters

Parameter	Specification			Unit	Condition
	Min.	Typ.	Max.		
Overall					Temp = 25 °C, V _{CC} = V _{DD} = 5V, standard application circuit
Frequency Range	3000		3800	MHz	
Max Gain		38		dB	Attenuation = 0dB, at 3500MHz
Gain Control Range		31.5		dB	
Step Accuracy	±(0.2 +15% attenuation setting)			dB	Major state error up to 3800MHz
P1dB		30.4		dBm	Attenuation = 0dB, at 3500MHz
Output IP3	34.6	40.5		dBm	P _{OUT} = 10dBm/Tone, 1MHz spacing at 3500MHz, minimum value occurs at low temperature
Control Interface		6		bit	SPI Interface
Settling Time		250		ns	t _{ON} , t _{OFF} (10%/90% RF)
Noise Figure		4.8		dB	Attenuation = 0dB, 3500MHz
Impedance		50		Ω	
Input Return Loss		19		dB	At 3500MHz
Output Return Loss		11		dB	
Total Supply Voltage	4.75	5.0	5.25	V	
Supply Current		250		mA	From V _{CC} (SPI), V _{CC} (AMP1), and V _{CC} (AMP2)
Thermal Resistance		30		°C/W	Junction to backside of device

Typical RF Performance at Key Operating Frequencies

Parameter	Unit	3000MHz	3300MHz	3400MHz	3500MHz	3600MHz	3700MHz	3800MHz
Max Small Signal Gain	dB	36.6	37.6	38.0	38.1	37.9	37.3	36.0
Output P1dB	dBm	31.5	31.4	31.0	30.4	30.0	29.4	28.6
Output IP3*	dBm	36.3	39.4	39.4	40.5	40.8	41.5	41.1
Input Return Loss	dB	15.8	19.8	19.7	19.8	21.1	23.0	22.2
Output Return Loss	dB	12.6	10.7	10.6	11.2	12.4	13.1	12.1
Noise Figure	dB	4.8	4.8	4.8	4.8	4.9	5.0	5.0

*Note: OIP3 is tested at P_{OUT} = 10dBm/Tone and 1MHz spacing

Typical Performance

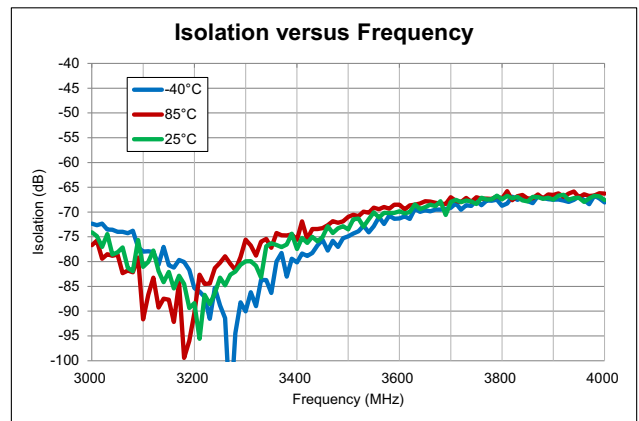
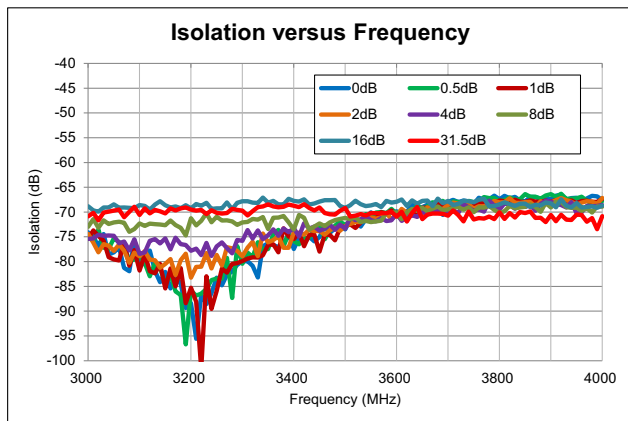
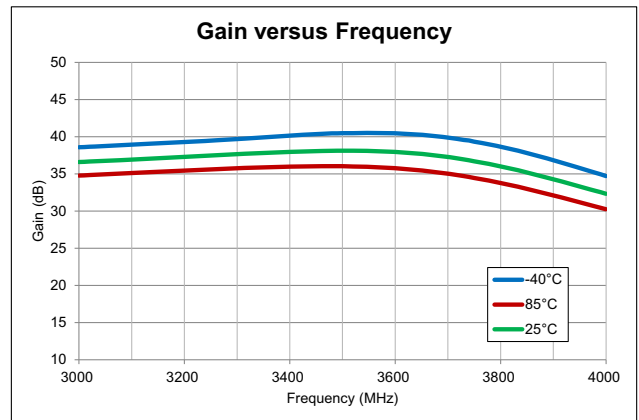
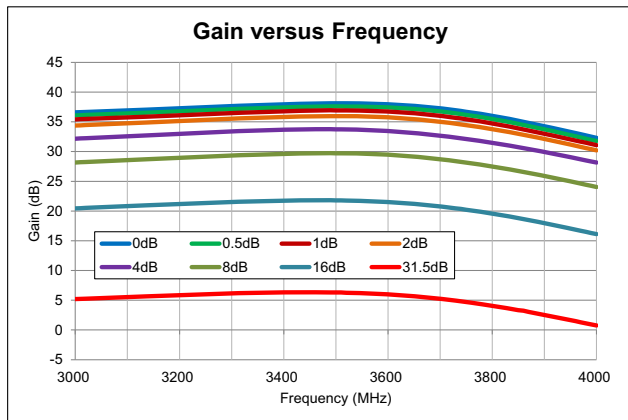
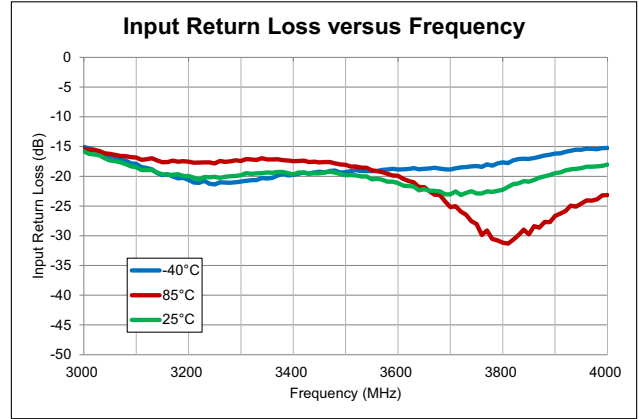
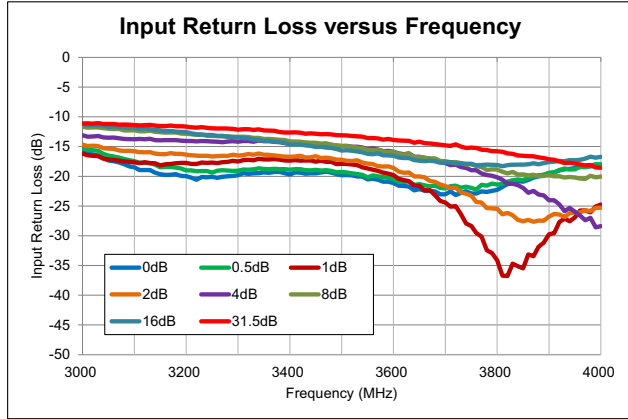

Typical Performance

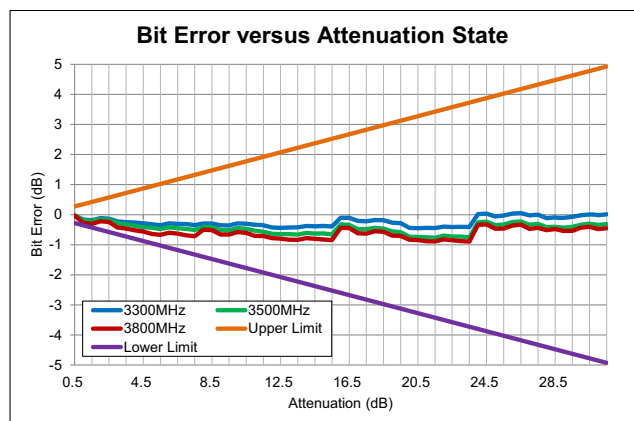
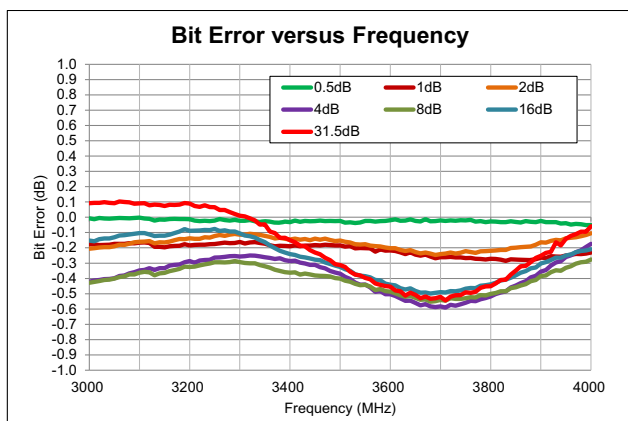
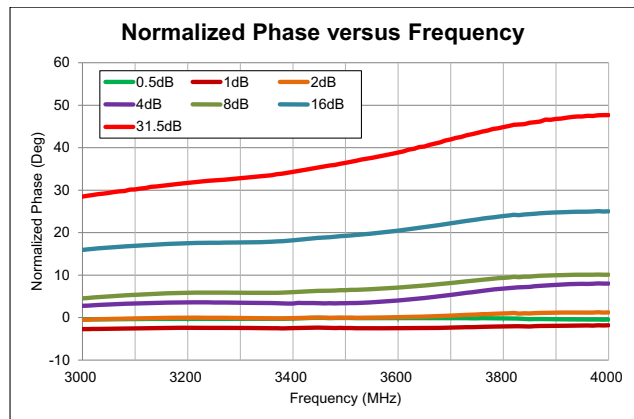
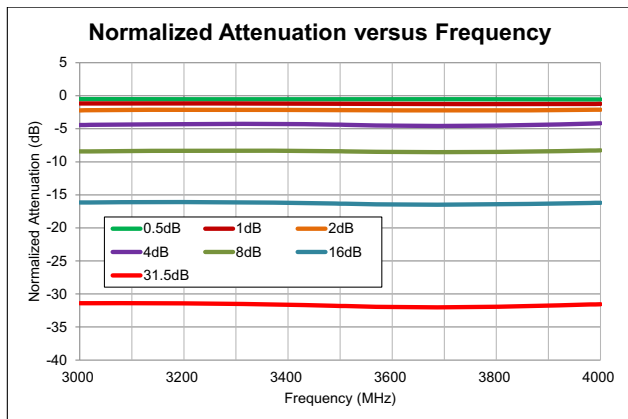
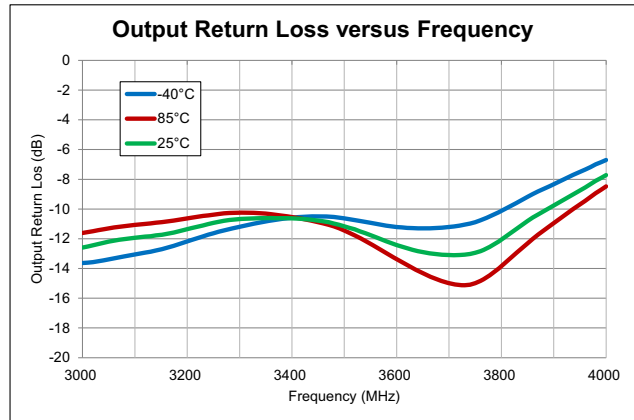
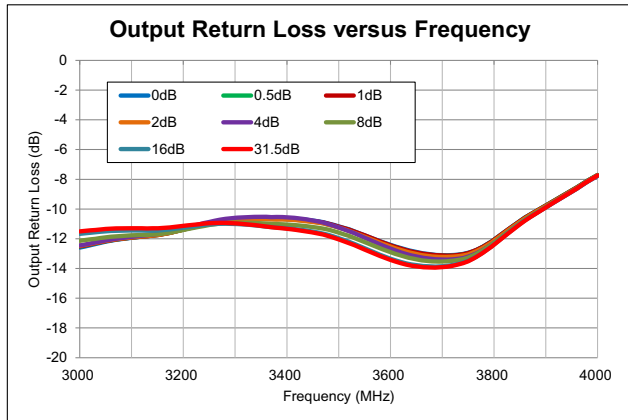

Typical Performance

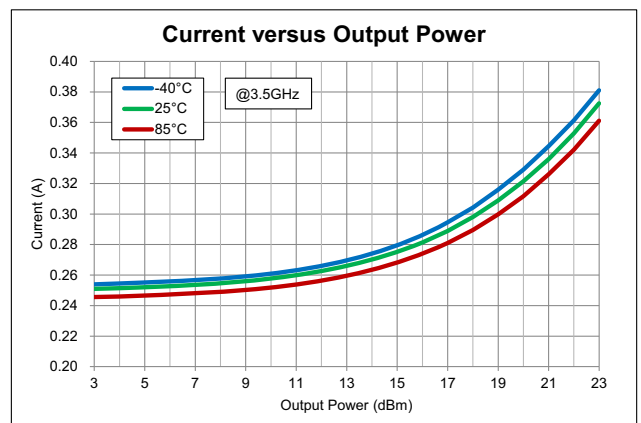
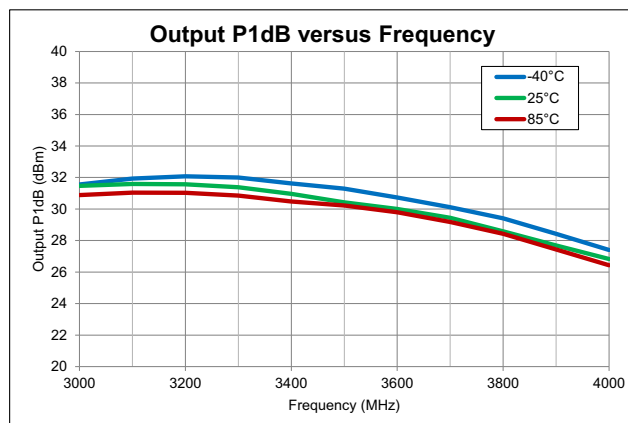
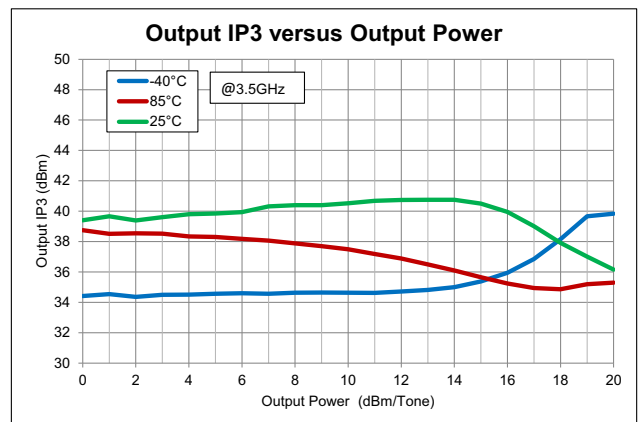
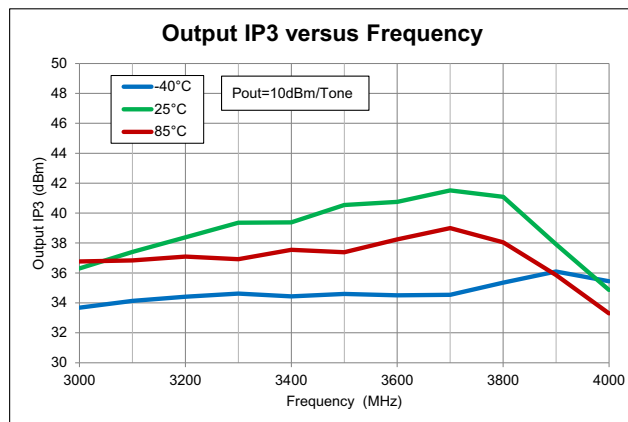
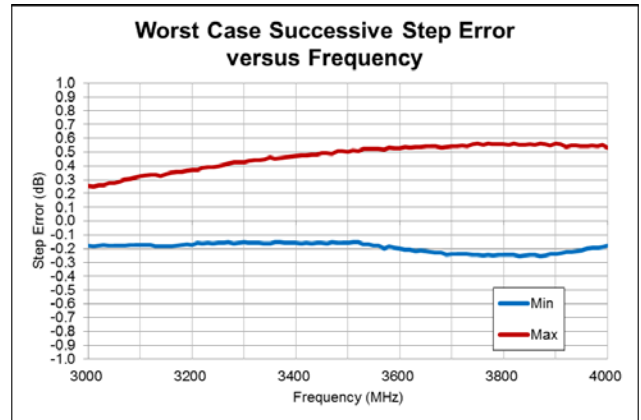
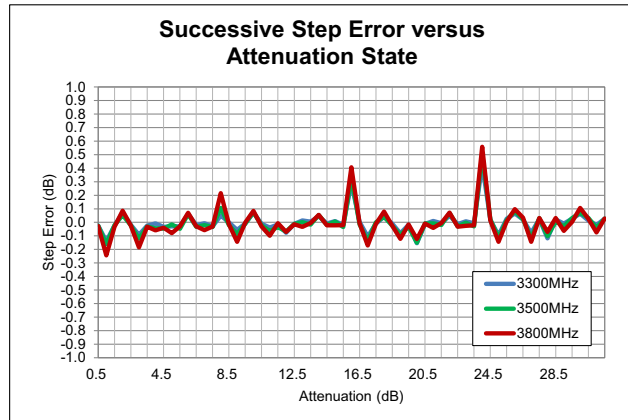

Truth Table

Control Bit						Gain Relative to Max Gain
D5	D4	D3	D2	D1	D0	
1	1	1	1	1	1	0dB
1	1	1	1	1	0	-0.5dB
1	1	1	1	0	1	-1dB
1	1	1	0	1	1	-2dB
1	1	0	1	1	1	-4dB
1	0	1	1	1	1	-8dB
0	1	1	1	1	1	-16dB
0	0	0	0	0	0	-31.5dB

Serial Port Interface: SPI Timing Diagram

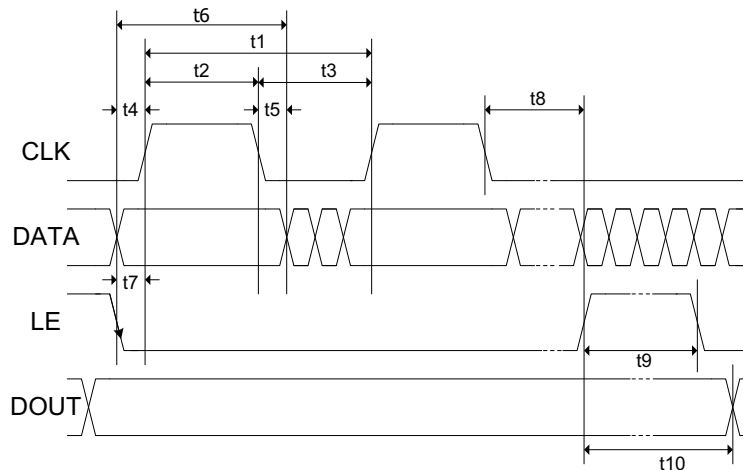

SPI Timing Diagram Specifications

Parameter	Limit	Unit	Comment
t1	25	MHz max	CLK Frequency
t2	20	ns min	CLK High
t3	20	ns min	CLK Low
t4	5	ns min	DATA to CLK Setup Time
t5	5	ns min	DATA to CLK Hold Time
t6	30	ns min	DATA Valid
t7	5	ns min	LE to CLK Setup Time
t8	5	ns min	CLK to LE Setup Time
t9	10	ns min	LE Pulse Width
t10	20	ns max	Output Set

Programming Example - 6-Bit

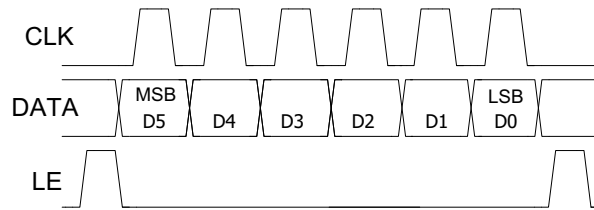

Control Voltage Table	
State	Logic
Low	0V to 0.8V
High	2.0V to 5.0V

Power-up Programming Truth Table	
PUP	Attenuator Setting
Low	Attenuation at Max, 31.5dB
High	Attenuation at Min, 0dB

Evaluation Board Schematic

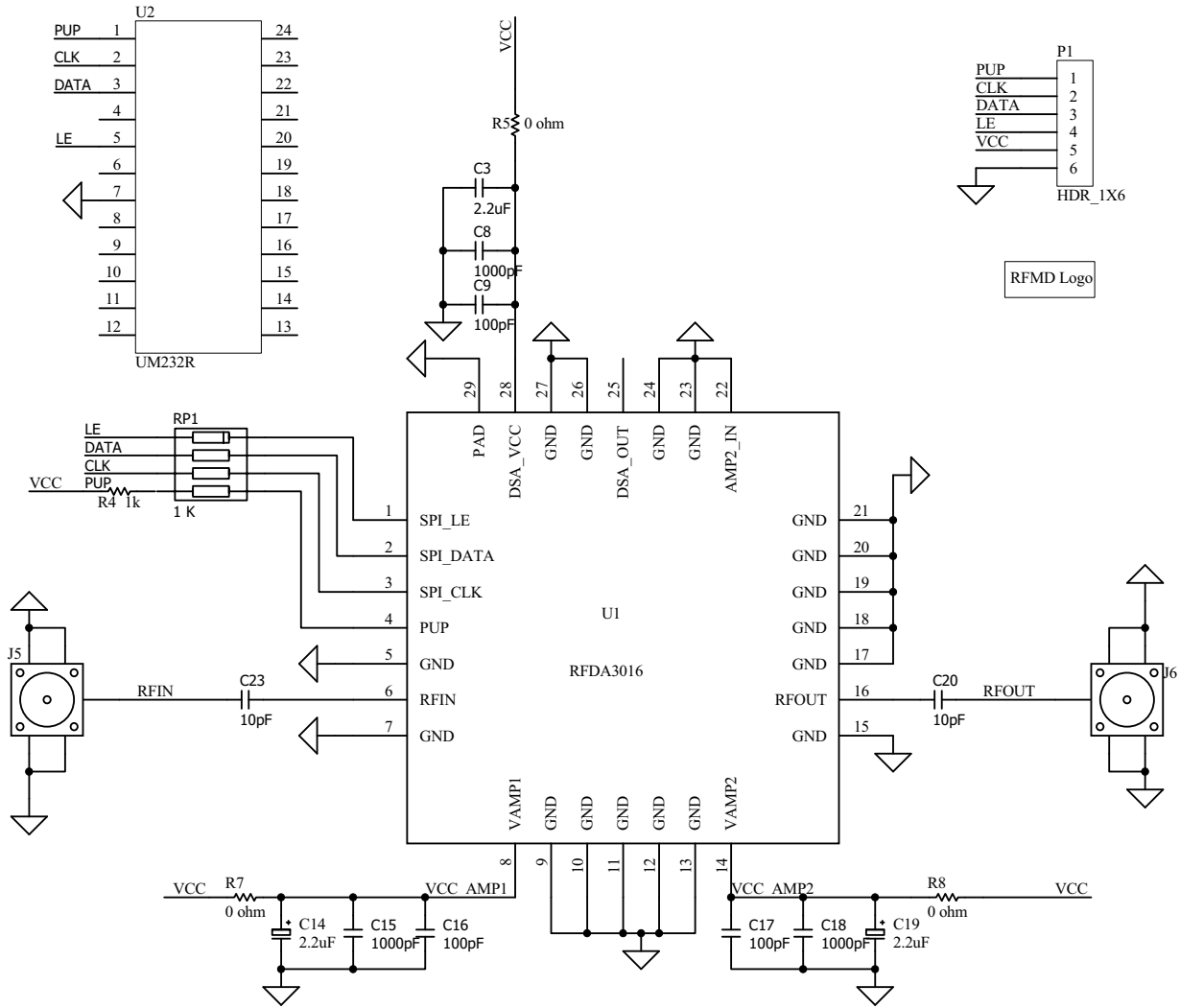

Evaluation Board Bill of Materials (BOM)

Description	Reference Designator	Manufacturer	Manufacturer's P/N
RFDA3016, 6mm x 6sq. mm, 28-Pin Laminate	U1	RFMD	RFDA3016
RFDA3016 Evaluation Board			RFDA3016EVB(B)
RES ARRAY, 4-ELEM, 1K, 5%, SMD 4x0402	RP1	KOA Speer Electronics, Inc.	CN1E4KTTD102J
RES, 1K, 5%, 1/16W, 0603	R4	Panasonic Industrial Co.	ERJ-3GEYJ102
CAP, 100pF, 5%, 50V, COG, 0402	C9, C16-C17	Murata Electronics	GRM1555C1H101JA01D
CAP, 1000pF, 10%, 50V, X7R, 0402	C8, C15, C18	Murata Electronics	GRM155R71H102KA01D
CAP, 2.2uF, 10%, 10V, X7R, 0603	C3, C14, C19	TDK Corporation	C1608X7R1A225K
CAP, 10pF, 5%, 50V, COG, 0402	C20, C23	Murata Electronics	GRM1555C1H100JA01D
RES, 0Ω, 0603	R5, R7-R8	KOA Speer Electronics, Inc.	RK73Z1JLTD
CONN, SMA, END LNCH, FLT, 0.062"	J5-J6	Emerson Network Power	142-0701-821
CONN, HDR, ST, PLRZD, 6-PIN, 0.100"	P1	AMP	640454-6
DNP	U2		

Evaluation Board Assembly Drawing

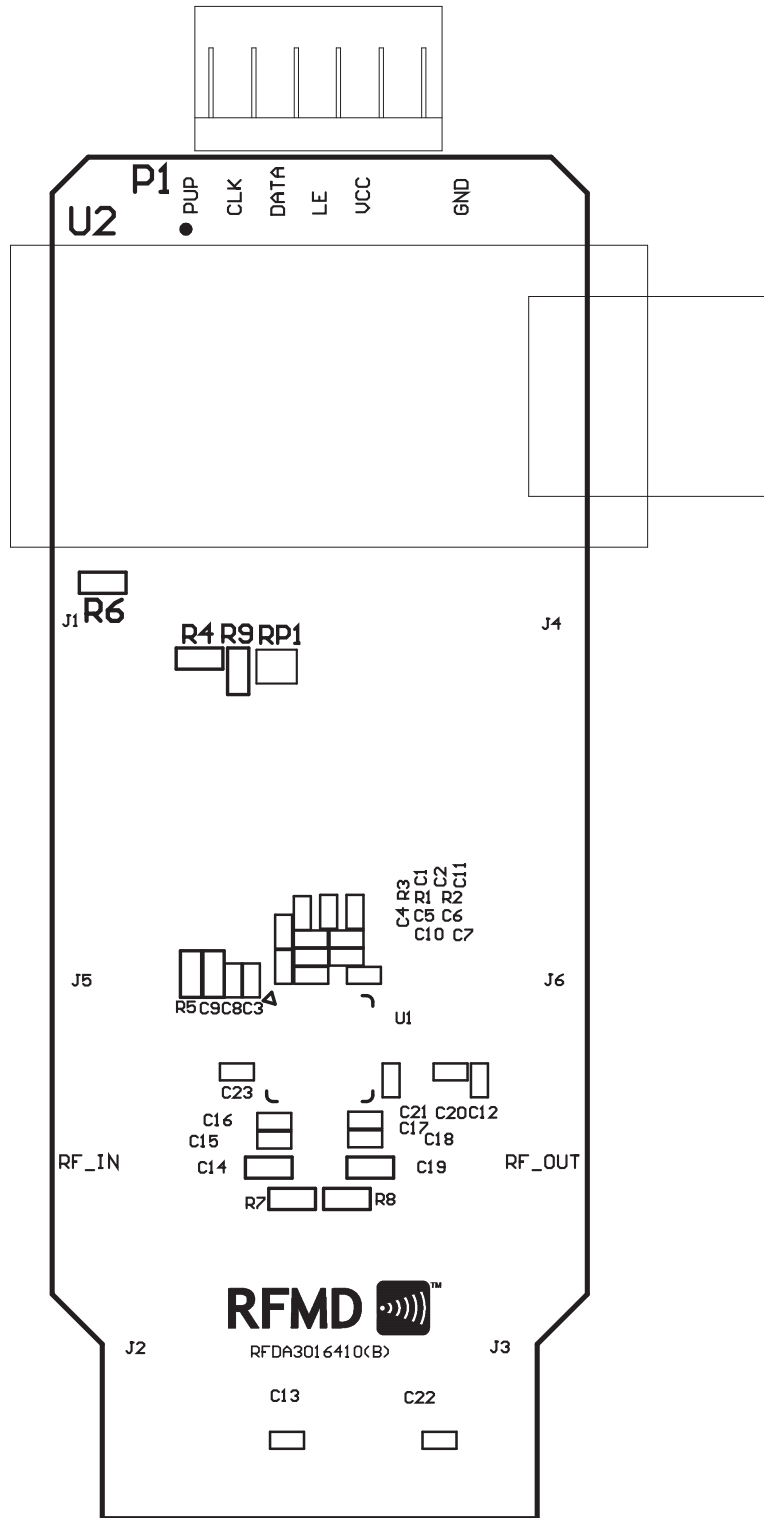

Pin Names and Description

Pin	Function	Description
1	SPI_LE	Serial Latch Enable Input
2	SPI_DATA	Serial Data Input
3	SPI_CLK	Serial Clock Input
4	PUP	Power-up Programming Pin
5	GND	RF/DC Ground Connection
6	RF_IN	RF Input, AC Coupled
7	GND	RF/DC Ground Connection
8	VCC_AMP1	Supply Voltage for Amplifier 1
9	GND	RF/DC Ground Connection
10	GND	RF/DC Ground Connection
11	GND	RF/DC Ground Connection
12	GND	RF/DC Ground Connection
13	GND	RF/DC Ground Connection
14	VCC_AMP2	Supply Voltage for Amplifier 2
15	GND	RF/DC Ground Connection
16	RF_OUT	RF Output, AC Coupled
17	GND	RF/DC Ground Connection
18	GND	RF/DC Ground Connection
19	GND	RF/DC Ground Connection
20	GND	RF/DC Ground Connection
21	GND	RF/DC Ground Connection
22	NC	Do Not Connect, Leave Open Circuit
23	GND	RF/DC Ground Connection
24	GND	RF/DC Ground Connection
25	GND	RF/DC Ground Connection
26	GND	RF/DC Ground Connection
27	GND	RF/DC Ground Connection
28	VCC_SPI	Supply Voltage for SPI and DSA Chip

Package Drawing:
6.0mm x 6.0mm Laminate Module

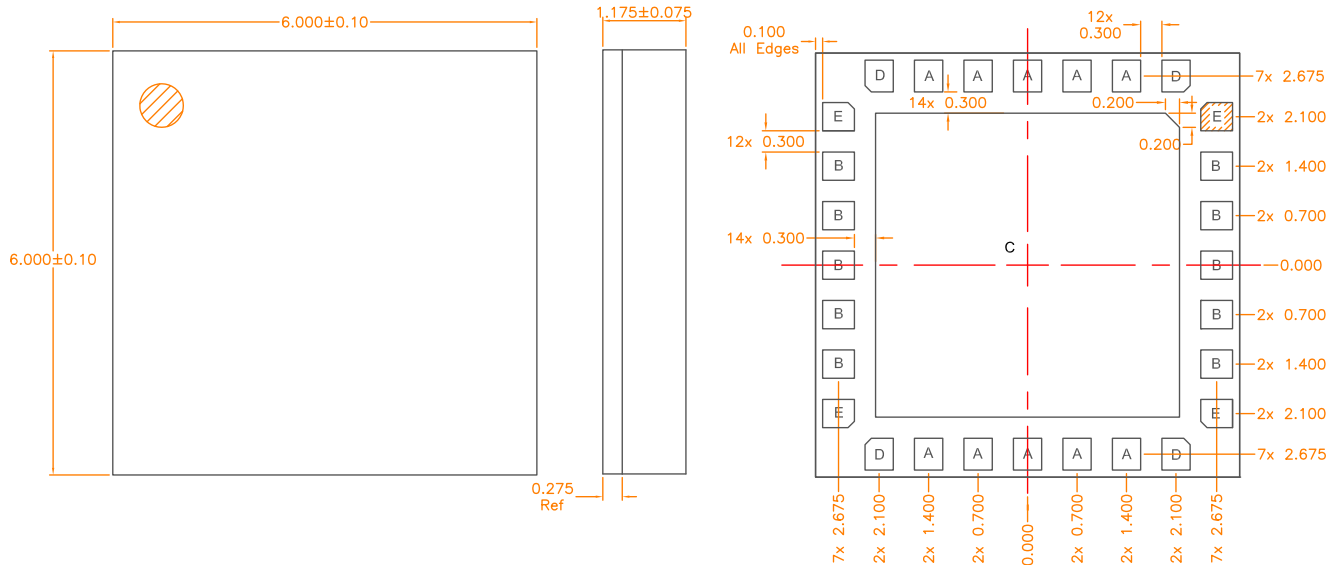

- A = 0.400 x 0.450 mm
- B = 0.450 x 0.400 mm
- C = 4.300 x 4.300 mm
- D = See Details
- E = See Details

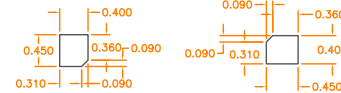

Notes:

1. Shaded area represents Pin 1 location.

Branding Diagram

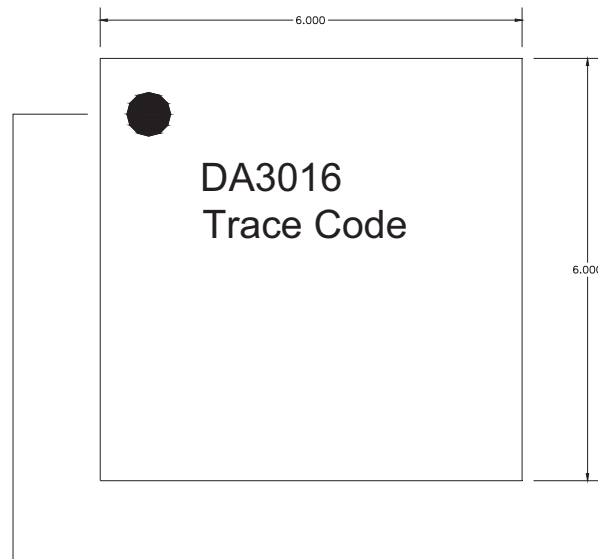

Pin 1 Indicator

Trace Code to be assigned by SubCon