

**POWER MOS 7® IGBT**

The POWER MOS 7® IGBT is a new generation of high voltage power IGBTs. Using Punch Through Technology this IGBT is ideal for many high frequency, high voltage switching applications and has been optimized for high frequency switchmode power supplies.

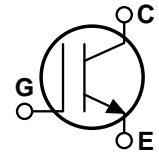
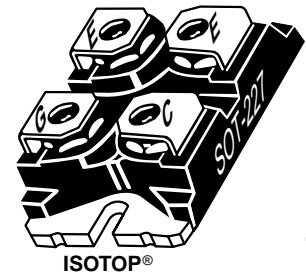

- **Low Conduction Loss**
- **Low Gate Charge**
- **Ultrafast Tail Current shutoff**
- **50 kHz operation @ 800V, 16A**
- **20 kHz operation @ 800V, 30A**
- **RBSOA rated**

**MAXIMUM RATINGS**

 All Ratings:  $T_C = 25^\circ\text{C}$  unless otherwise specified.

Symbol	Parameter	APT45GP120J	UNIT
$V_{CES}$	Collector-Emitter Voltage	1200	Volts
$V_{GE}$	Gate-Emitter Voltage	$\pm 20$	
$V_{GEM}$	Gate-Emitter Voltage Transient	$\pm 30$	
$I_{C1}$	Continuous Collector Current @ $T_C = 25^\circ\text{C}$	75	Amps
$I_{C2}$	Continuous Collector Current @ $T_C = 110^\circ\text{C}$	34	
$I_{CM}$	Pulsed Collector Current <sup>①</sup> @ $T_C = 25^\circ\text{C}$	170	
RBSOA	Reverse Bias Safe Operating Area @ $T_J = 150^\circ\text{C}$	170A @ 960V	
$P_D$	Total Power Dissipation	329	Watts
$T_J, T_{STG}$	Operating and Storage Junction Temperature Range	-55 to 150	$^\circ\text{C}$
$T_L$	Max. Lead Temp. for Soldering: 0.063" from Case for 10 Sec.	300	

**STATIC ELECTRICAL CHARACTERISTICS**

Symbol	Characteristic / Test Conditions	MIN	TYP	MAX	UNIT
$BV_{CES}$	Collector-Emitter Breakdown Voltage ( $V_{GE} = 0V, I_C = 500\mu\text{A}$ )	1200			Volts
$V_{GE(TH)}$	Gate Threshold Voltage ( $V_{CE} = V_{GE}, I_C = 1\text{mA}, T_J = 25^\circ\text{C}$ )	3	4.5	6	
$V_{CE(ON)}$	Collector-Emitter On Voltage ( $V_{GE} = 15V, I_C = 45A, T_J = 25^\circ\text{C}$ )		3.3	3.9	
	Collector-Emitter On Voltage ( $V_{GE} = 15V, I_C = 45A, T_J = 125^\circ\text{C}$ )		3.0		
$I_{CES}$	Collector Cut-off Current ( $V_{CE} = 1200V, V_{GE} = 0V, T_J = 25^\circ\text{C}$ ) <sup>②</sup>			500	$\mu\text{A}$
	Collector Cut-off Current ( $V_{CE} = 1200V, V_{GE} = 0V, T_J = 125^\circ\text{C}$ ) <sup>②</sup>			2500	
$I_{GES}$	Gate-Emitter Leakage Current ( $V_{GE} = \pm 20V$ )			$\pm 100$	nA

 **CAUTION:** These Devices are Sensitive to Electrostatic Discharge. Proper Handling Procedures Should Be Followed.

APT Website - <http://www.advancedpower.com>

## DYNAMIC CHARACTERISTICS

APT45GP120J

Symbol	Characteristic	Test Conditions	MIN	TYP	MAX	UNIT	
$C_{ies}$	Input Capacitance	<b>Capacitance</b> $V_{GE} = 0V, V_{CE} = 25V$ $f = 1 \text{ MHz}$		3935		pF	
$C_{oes}$	Output Capacitance			300			
$C_{res}$	Reverse Transfer Capacitance			55			
$V_{GEP}$	Gate-to-Emitter Plateau Voltage	<b>Gate Charge</b> $V_{GE} = 15V$ $V_{CE} = 600V$ $I_C = 45A$		7.5		V	
$Q_g$	Total Gate Charge <sup>③</sup>			185		nC	
$Q_{ge}$	Gate-Emitter Charge			25			
$Q_{gc}$	Gate-Collector ("Miller") Charge			80			
RBSOA	Safe Operating Area	$T_J = 150^\circ\text{C}, R_G = 5\Omega, V_{GE} = 15V, L = 100\mu\text{H}, V_{CE} = 960V$	170			A	
$t_{d(on)}$	Turn-on Delay Time	<b>Inductive Switching (25°C)</b> $V_{CC} = 600V$ $V_{GE} = 15V$ $I_C = 45A$ $R_G = 5\Omega$ $T_J = +25^\circ\text{C}$		18		ns	
$t_r$	Current Rise Time			29			
$t_{d(off)}$	Turn-off Delay Time			102			
$t_f$	Current Fall Time			38			
$E_{on1}$	Turn-on Switching Energy <sup>④</sup>				900		$\mu\text{J}$
$E_{on2}$	Turn-on Switching Energy (Diode) <sup>⑤</sup>				1869		
$E_{off}$	Turn-off Switching Energy <sup>⑥</sup>				904		
$t_{d(on)}$	Turn-on Delay Time		<b>Inductive Switching (125°C)</b> $V_{CC} = 600V$ $V_{GE} = 15V$ $I_C = 45A$ $R_G = 5\Omega$ $T_J = +125^\circ\text{C}$		18		ns
$t_r$	Current Rise Time			29			
$t_{d(off)}$	Turn-off Delay Time			151			
$t_f$	Current Fall Time			79			
$E_{on1}$	Turn-on Switching Energy <sup>④</sup>				900		$\mu\text{J}$
$E_{on2}$	Turn-on Switching Energy (Diode) <sup>⑤</sup>				3078		
$E_{off}$	Turn-off Switching Energy <sup>⑥</sup>				2254		

## THERMAL AND MECHANICAL CHARACTERISTICS

Symbol	Characteristic	MIN	TYP	MAX	UNIT
$R_{\theta JC}$	Junction to Case (IGBT)			.38	$^\circ\text{C/W}$
$R_{\theta JC}$	Junction to Case (DIODE)			N/A	
$W_T$	Package Weight			29.2	gm

① Repetitive Rating: Pulse width limited by maximum junction temperature.

② For Combi devices,  $I_{ces}$  includes both IGBT and FRED leakages

③ See MIL-STD-750 Method 3471.

④  $E_{on1}$  is the clamped inductive turn-on-energy of the IGBT only, without the effect of a commutating diode reverse recovery current adding to the IGBT turn-on loss. (See Figure 24.)

⑤  $E_{on2}$  is the clamped inductive turn-on energy that includes a commutating diode reverse recovery current in the IGBT turn-on switching loss. (See Figures 21, 22.)

⑥  $E_{off}$  is the clamped inductive turn-off energy measured in accordance with JEDEC standard JESD24-1. (See Figures 21, 23.)

APT Reserves the right to change, without notice, the specifications and information contained herein.

**TYPICAL PERFORMANCE CURVES**

**APT45GP120J**

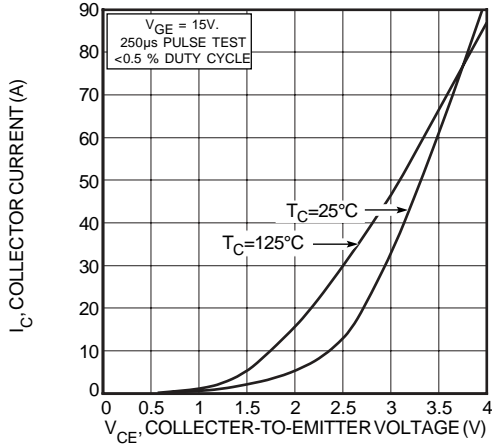

**FIGURE 1, Output Characteristics ( $V_{GE} = 15V$ )**

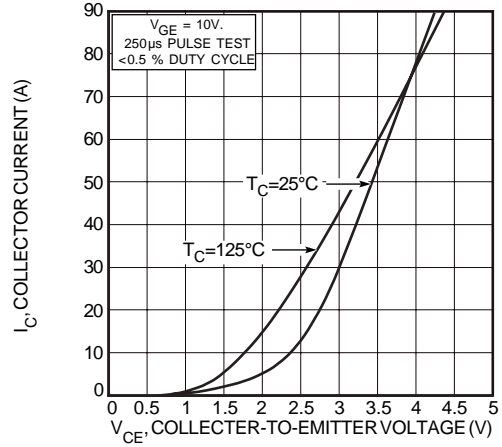

**FIGURE 2, Output Characteristics ( $V_{GE} = 10V$ )**

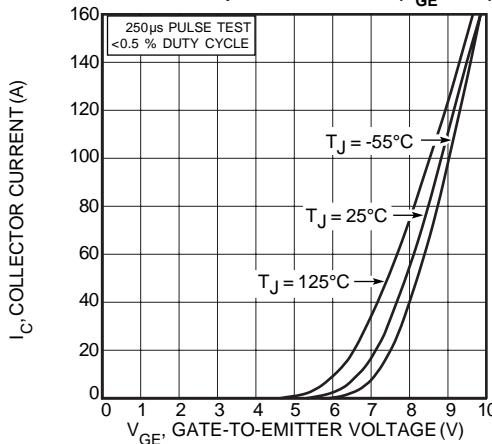

**FIGURE 3, Transfer Characteristics**

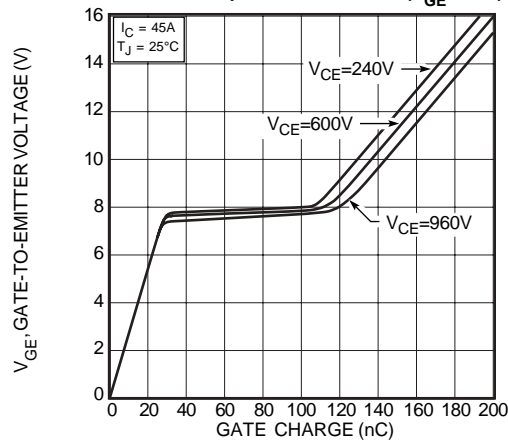

**FIGURE 4, Gate Charge**

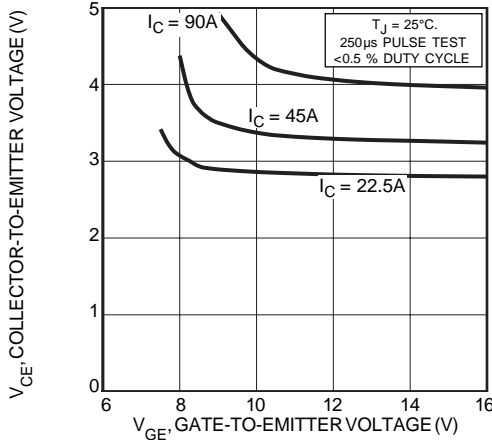

**FIGURE 5, On State Voltage vs Gate-to-Emitter Voltage**

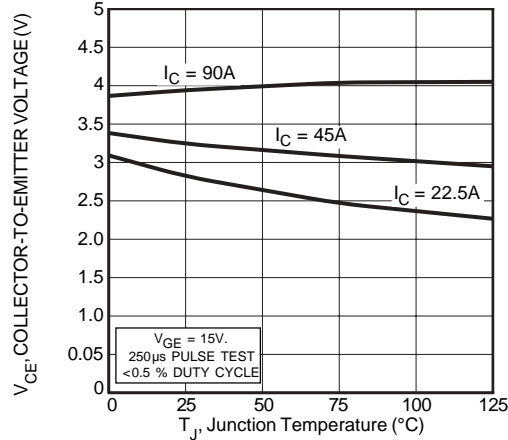

**FIGURE 6, On State Voltage vs Junction Temperature**

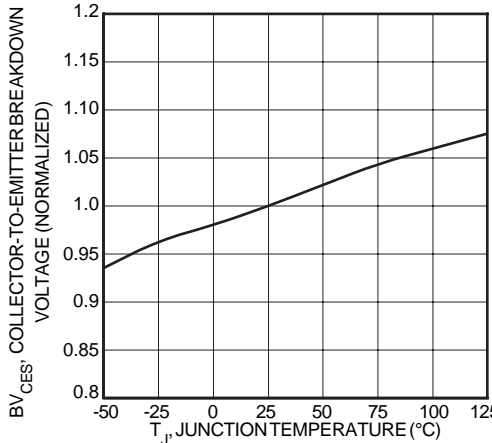

**FIGURE 7, Breakdown Voltage vs. Junction Temperature**

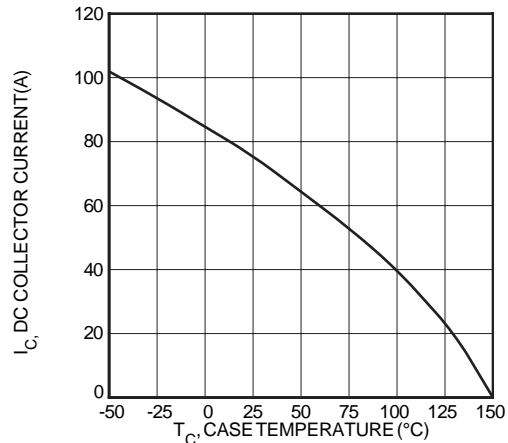

**FIGURE 8, DC Collector Current vs Case Temperature**

# TYPICAL PERFORMANCE CURVES

APT45GP120J

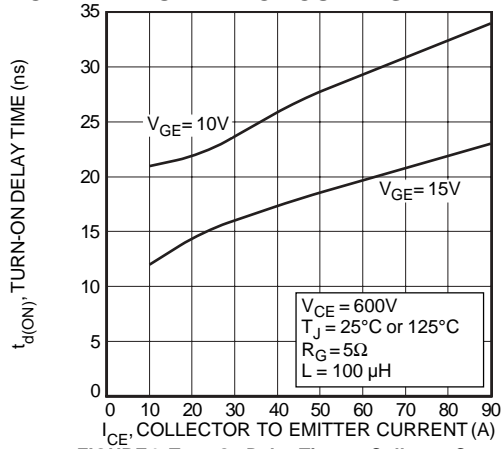

FIGURE 9, Turn-On Delay Time vs Collector Current

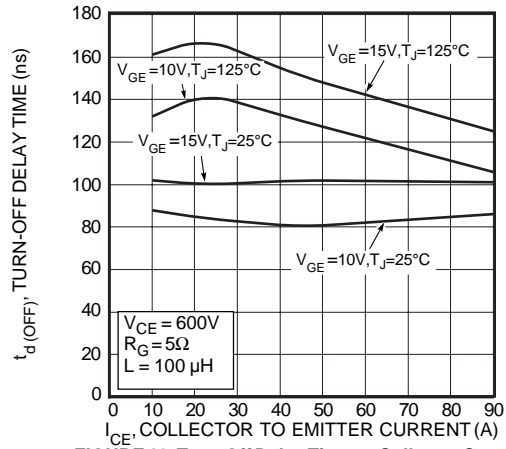

FIGURE 10, Turn-Off Delay Time vs Collector Current

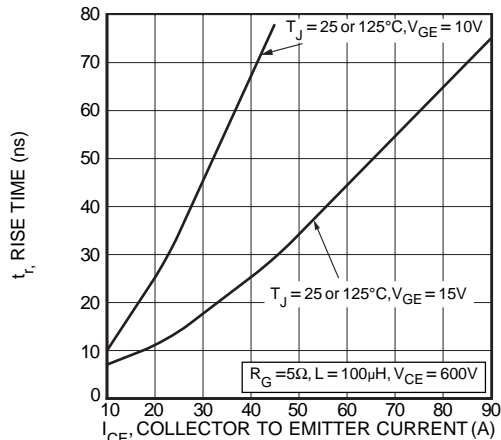

FIGURE 11, Current Rise Time vs Collector Current

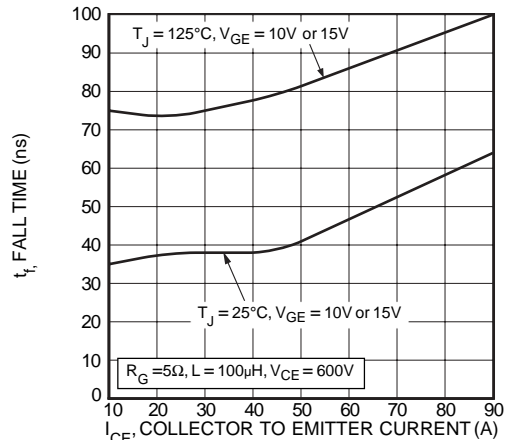

FIGURE 12, Current Fall Time vs Collector Current

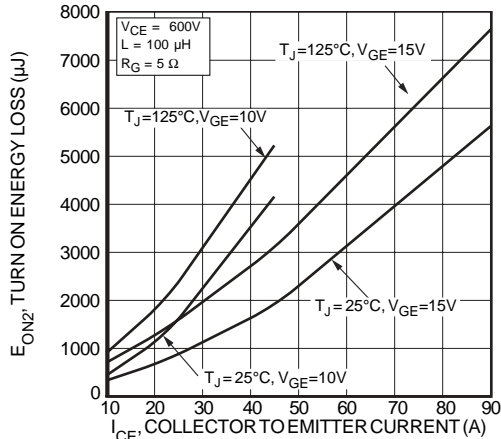

FIGURE 13, Turn-On Energy Loss vs Collector Current

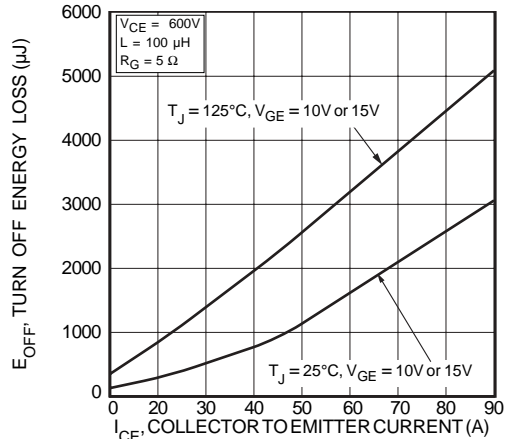

FIGURE 14, Turn Off Energy Loss vs Collector Current

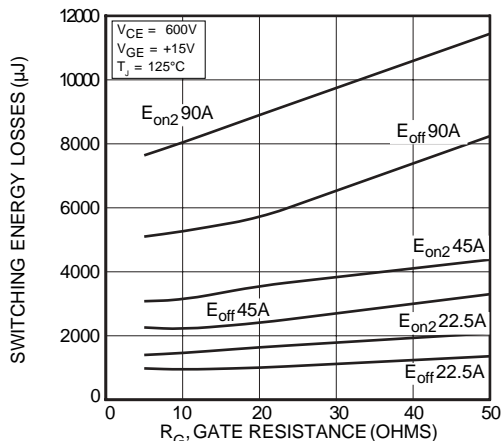

FIGURE 15, Switching Energy Losses vs. Gate Resistance

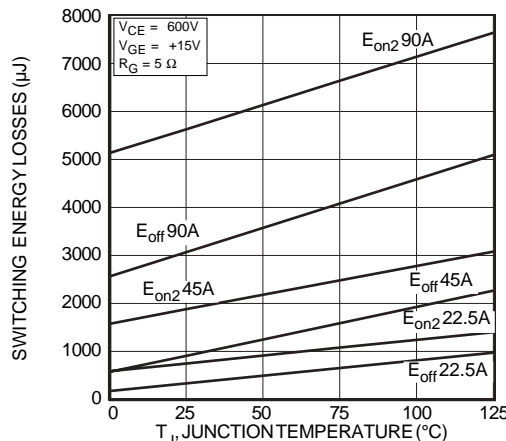

FIGURE 16, Switching Energy Losses vs Junction Temperature

TYPICAL PERFORMANCE CURVES

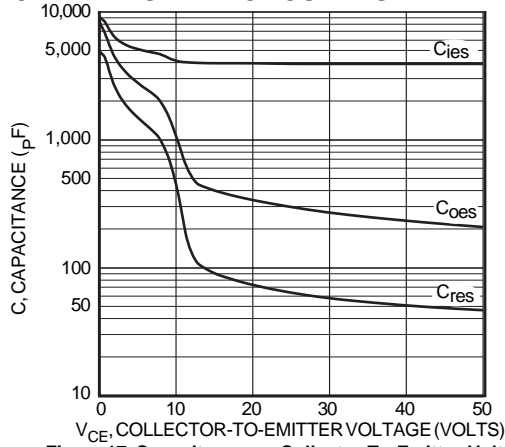

Figure 17, Capacitance vs Collector-To-Emitter Voltage

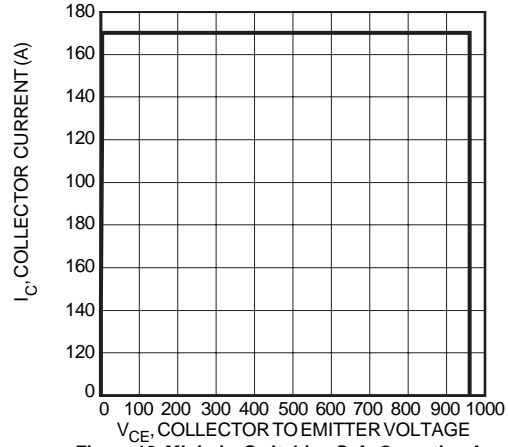

Figure 18, Minimum Switching Safe Operating Area

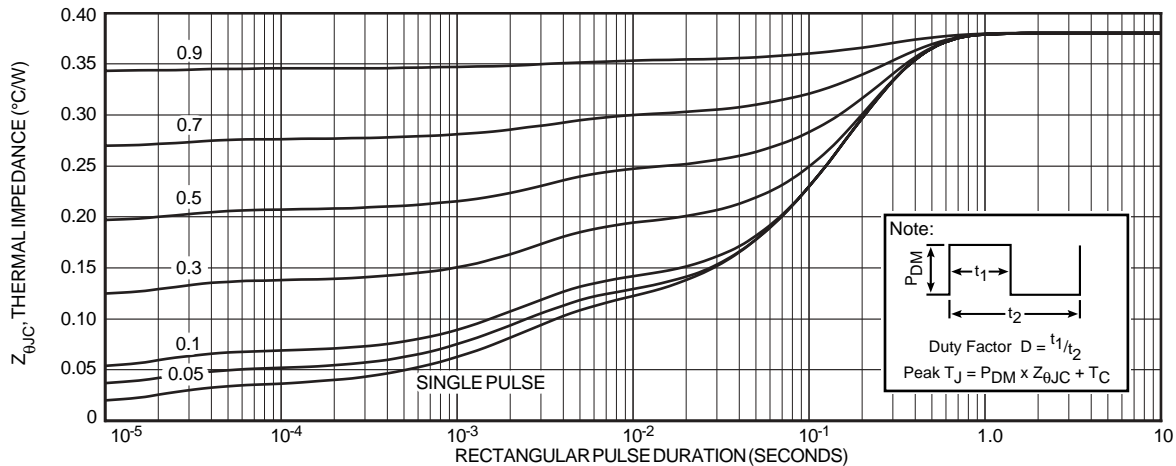

FIGURE 1, MAXIMUM EFFECTIVE TRANSIENT THERMAL IMPEDANCE, JUNCTION-TO-CASE vs PULSE DURATION

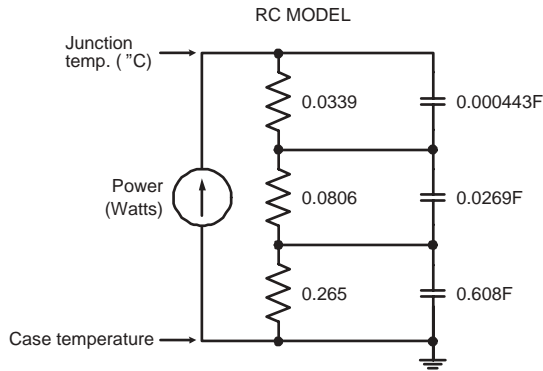

FIGURE 19B, TRANSIENT THERMAL IMPEDANCE MODEL

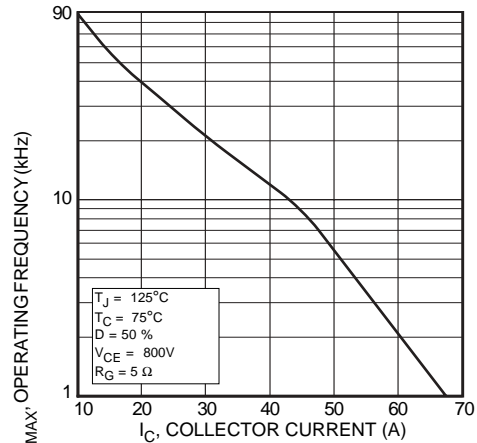

Figure 20, Operating Frequency vs Collector Current

$$F_{max} = \min(f_{max1}, f_{max2})$$

$$f_{max1} = \frac{0.05}{t_{d(on)} + t_r + t_{d(off)} + t_f}$$

$$f_{max2} = \frac{P_{diss} - P_{cond}}{E_{on2} + E_{off}}$$

$$P_{diss} = \frac{T_J - T_C}{R_{\theta JC}}$$

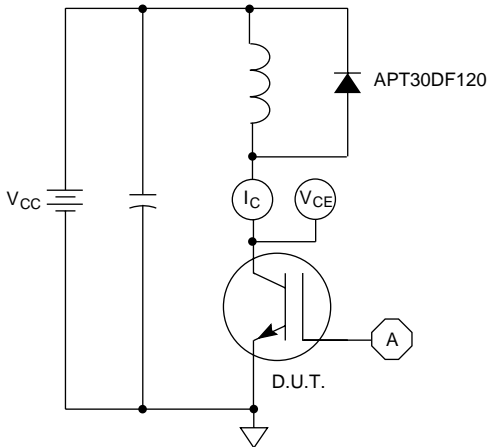

Figure 21, Inductive Switching Test Circuit

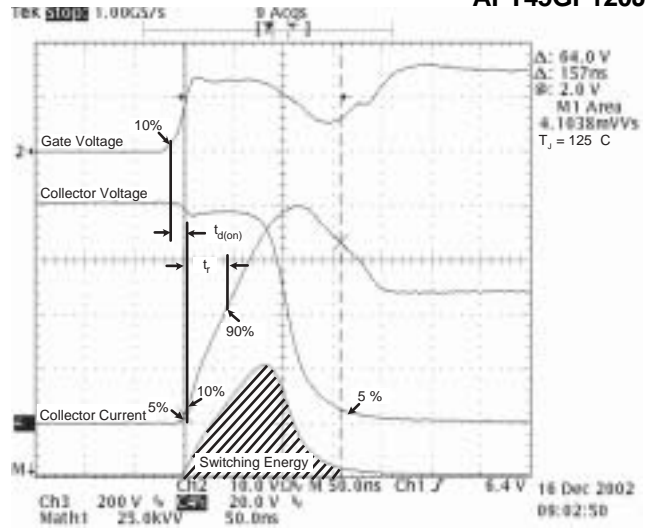

Figure 22, Turn-on Switching Waveforms and Definitions

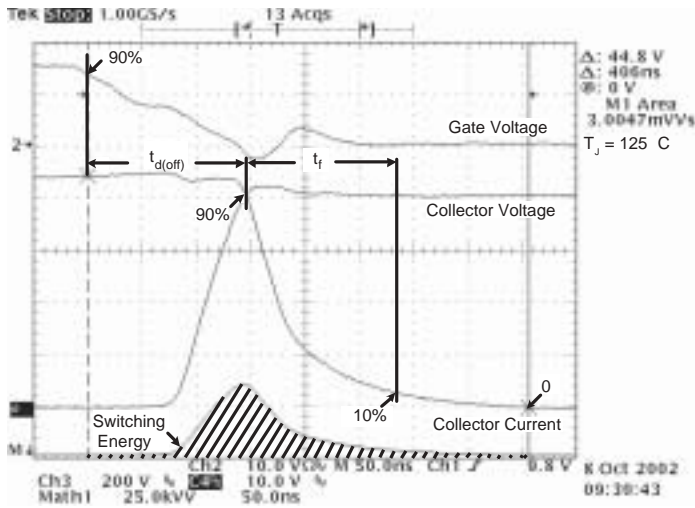

Figure 23, Turn-off Switching Waveforms and Definitions

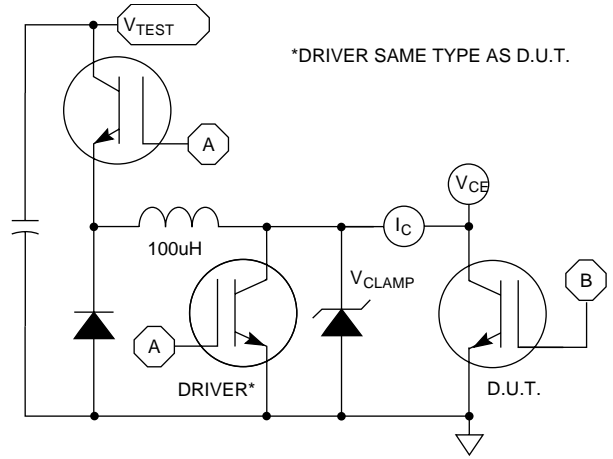
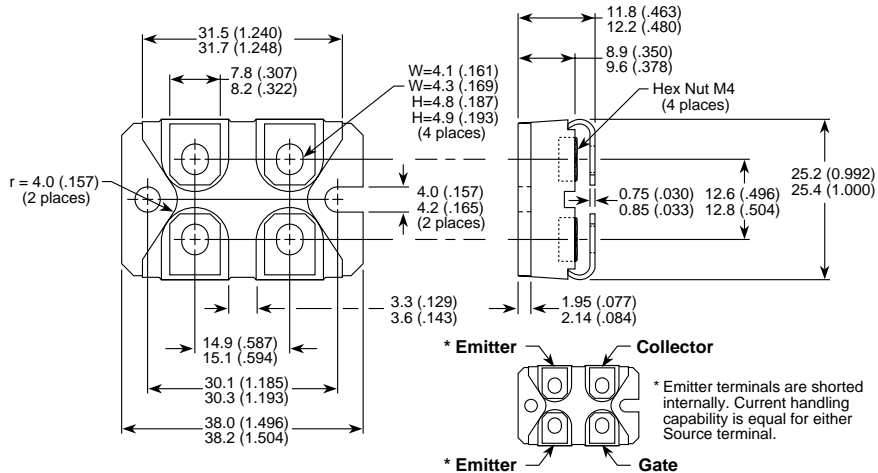

Figure 24, E<sub>ON1</sub> Test Circuit

SOT-227 (ISOTOP®) Package Outline



Dimensions in Millimeters and (Inches)