



### Main

Range of product	Harmony XB4
Product or component type	Head for non-illuminated push-button
Device short name	ZB4
Bezel material	Chromium plated metal
Mounting diameter	0.87 in (22 mm)
Sale per indivisible quantity	1
Head type	Standard
Shape of signaling unit head	Round
Type of operator	Spring return
Operator profile	White recessed unmarked
Operator additional information	High guard

### Complementary

CAD overall width	1.14 in (29 mm)
CAD overall height	1.14 in (29 mm)
CAD overall depth	1.22 in (31 mm)
Mechanical durability	10000000 cycles
Electrical composition code	C15 1 contacts using single blocks in front mounting C15 1 contacts using single blocks in front mounting C11 for 3 contacts using single blocks in front mounting C1 for 9 contacts using single blocks in front mounting C2 for 9 contacts using single and double blocks in front mounting

### Environment

protective treatment	TH
ambient air temperature for storage	-40...158 °F (-40...70 °C)
ambient air temperature for operation	-40...158 °F (-40...70 °C)
overvoltage category	Class I conforming to IEC 60536
IP degree of protection	IP67 IP66 conforming to IEC 60529 IP69K IP69
NEMA degree of protection	NEMA 13 NEMA 4X
IK degree of protection	IK06 conforming to IEC 50102
standards	EN/IEC 60947-1 EN/IEC 60947-5-1 EN/IEC 60947-5-4 EN/IEC 60947-5-5 JIS C 4520 UL 508 CSA C22.2 No 14
product certifications	BV CSA DNV GL LROS (Lloyds register of shipping) RINA UL listed
vibration resistance	5 gn (f = 2...500 Hz) conforming to IEC 60068-2-6
shock resistance	30 gn (duration = 18 ms) half sine wave acceleration conforming to IEC 60068-2-27 50 gn (duration = 11 ms) half sine wave acceleration conforming to IEC 60068-2-27

### Offer Sustainability

The information provided in this documentation contains general descriptions and/or technical characteristics of the products contained herein. This documentation is not intended as a substitute for and is not to be used for determining suitability or reliability of these products for specific user applications. It is the duty of any such user or integrator to perform the appropriate and complete risk analysis, evaluation and testing of the products with respect to the relevant specific application or use thereof. Neither Schneider Electric Industries SAS nor any of its affiliates or subsidiaries shall be responsible or liable for misuse of the information contained herein.

WARNING: This product can expose you to chemicals including:

WARNING: This product can expose you to chemicals including:

Nickel compounds, which is known to the State of California to cause cancer, and

Nickel compounds, which is known to the State of California to cause cancer, and

Di-isodecyl phthalate (DIDP), which is known to the State of California to cause birth defects or other reproductive harm.

Di-isodecyl phthalate (DIDP), which is known to the State of California to cause birth defects or other reproductive harm.

For more information go to [www.p65warnings.ca.gov](http://www.p65warnings.ca.gov)

For more information go to [www.p65warnings.ca.gov](http://www.p65warnings.ca.gov)

## Contractual warranty

Warranty period

18 months

## Dimensions

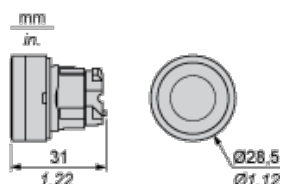

## Panel Cut-out for Pushbuttons, Switches and Pilot Lights (Finished Holes, Ready for Installation)

Connection by Screw Clamp Terminals or Plug-in Connectors or on Printed Circuit Board

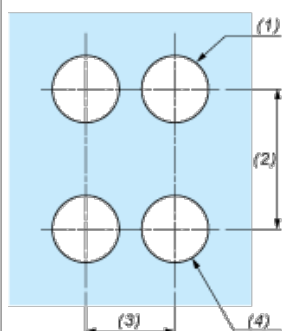

Connection by Faston Connectors

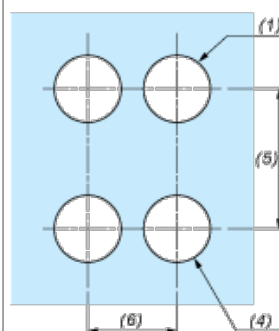

- (1) Diameter on finished panel or support
- (2) 40 mm min. / 1.57 in. min.
- (3) 30 mm min. / 1.18 in. min.
- (4)  $\varnothing$  22.5 mm / 0.89 in. recommended ( $\varnothing$  22.3 mm  $^{+0.4}_0$  / 0.88 in.  $^{+0.016}_0$ )
- (5) 45 mm min. / 1.78 in. min.
- (6) 32 mm min. / 1.26 in. min.

## Pushbuttons, Switches and Pilot Lights for Printed Circuit Board Connection

### Panel Cut-outs (Viewed from Installer's Side)



A: 30 mm min. / 1.18 in. min.

B: 40 mm min. / 1.57 in. min.

**Printed Circuit Board Cut-outs (Viewed from Electrical Block Side)**

Dimensions in mm



A: 30 mm min.

B: 40 mm min.

Dimensions in in.

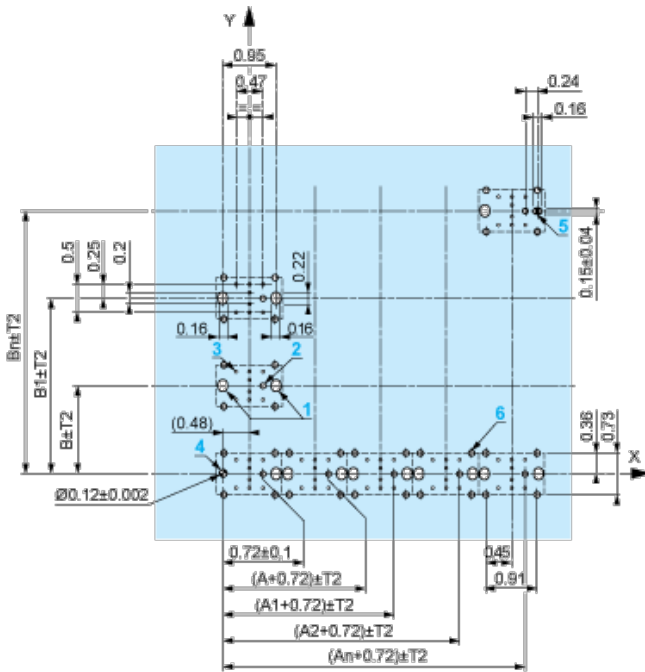

A: 1.18 in. min.

B: 1.57 in. min.

### General Tolerances of the Panel and Printed Circuit Board

The cumulative tolerance must not exceed 0.3 mm / 0.012 in:  $T1 + T2 = 0.3 \text{ mm max.}$

### Installation Precautions

- | Minimum thickness of circuit board: 1.6 mm / 0.06 in.
- | Cut-out diameter: 22.4 mm  $\pm$  0.1 / 0.88 in.  $\pm$  0.004
- | Orientation of body/fixing collar ZB4 BZ009:  $\pm 2^\circ 30'$  (excluding cut-outs marked **a** and **b**).
- | Tightening torque of screws ZBZ 006: 0.6 N.m (5.3 lbf.in) max.
- | Allow for one ZB4 BZ079 fixing collar/pillar and its fixing screws:
  - | every 90 mm / 3.54 in. horizontally (X), and 120 mm / 4.72 in. vertically (Y).
  - | with each selector switch head (ZB4 BD\*, ZB4 BJ\*, ZB4 BG\*).

The fixing centers marked **a** and **b** are diagonally opposed and must align with those marked 4 and 5.

$\frac{\text{mm}}{\text{in.}}$

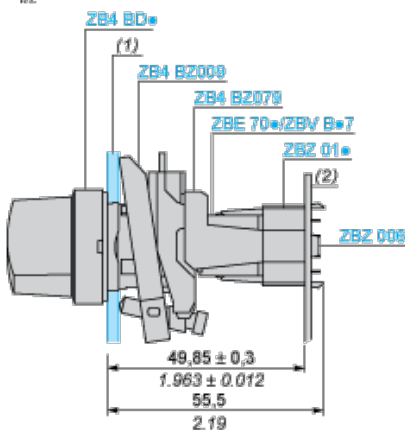

(1) Panel

(2) Printed circuit board

### Mounting of Adapter (Socket) ZBZ 01\*

- | 1 2 elongated holes for ZBZ 006 screw access
- | 2 1 hole  $\varnothing$  2.4 mm  $\pm$  0.05 / 0.09 in.  $\pm$  0.002 for centring adapter ZBZ 01\*
- | 3 8  $\times$   $\varnothing$  1.2 mm / 0.05 in. holes
- | 4 1 hole  $\varnothing$  2.9 mm  $\pm$  0.05 / 0.11 in.  $\pm$  0.002, for aligning the printed circuit board (with cut-out marked **a**)
- | 5 1 elongated hole for aligning the printed circuit board (with cut-out marked **b**)
- | 6 4 holes  $\varnothing$  2.4 mm / 0.09 in. for clipping in adapter ZBZ 01\*

### Electrical Composition Corresponding to Code C1

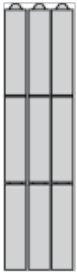

### Electrical Composition Corresponding to Code C2



### Electrical Composition Corresponding to Codes C9, C11, SF1 and SR1

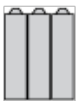

### Electrical Composition Corresponding to Code C15

1 N/O

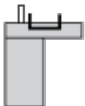

1 N/C



1 N/O + N/C or 1 N/O + N/O or 1 N/C + N/C



### Legend

Single contact



Double contact



Light block



Possible location

