

MMIC VCO w/ HALF FREQUENCY OUTPUT 14.5 - 15.0 GHz



Typical Applications

The HMC736LP4(E) is ideal for:

- Point to Point/Multipoint Radio
- Test Equipment & Industrial Controls
- SATCOM
- Military End-Use

Features

- Dual Output: $F_o = 14.5 - 15.0$ GHz
 $F_o/2 = 7.25 - 7.5$ GHz
- Pout: +9 dBm
- Phase Noise: -105 dBc/Hz @ 100 kHz
- No External Resonator Needed
- 24 Lead 4x4mm SMT Package: 16mm²

Functional Diagram

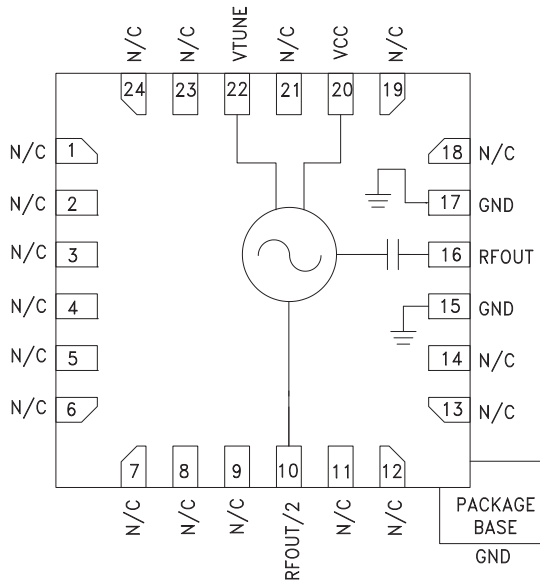

General Description

The HMC736LP4(E) is a GaAs InGaP Heterojunction Bipolar Transistor (HBT) MMIC VCO. The HMC736LP4(E) integrates a resonator, negative resistance device, varactor diode and feature half frequency output. The VCO's phase noise performance is excellent over temperature, shock, and process due to the oscillator's monolithic structure. Power output is +9 dBm typical from a +4.2V supply voltage. The voltage controlled oscillator is packaged in a leadless QFN 4x4 mm surface mount package, and requires no external matching components.

Electrical Specifications, $T_A = +25^\circ\text{C}$, $V_{CC} = +4.2\text{V}$

Parameter	Min.	Typ.	Max.	Units	
Frequency Range	F_o $F_o/2$	14.5 - 15.0 7.25 - 7.5		GHz GHz	
Power Output	RFOUT RFOUT/2	6 -8	9 -3	13 2	dBm dBm
SSB Phase Noise @ 100 kHz Offset, Vtune= +5V @ RFOUT		-105		dBc/Hz	
Tune Voltage	Vtune	1	13	V	
Supply Current		120	150	180	mA
Tune Port Leakage Current (Vtune= 13V)			10	μA	
Output Return Loss		2.5		dB	
Harmonics/Subharmonics	1/2 3/2	-45 -42		dBc dBc	
Pulling (into a 2.0:1 VSWR)		12		MHz pp	
Pushing @ Vtune= 5V		24		MHz/V	
Frequency Drift Rate		1.2		MHz/ $^\circ\text{C}$	

Information furnished by Analog Devices is believed to be accurate and reliable. However, no responsibility is assumed by Analog Devices for its use, nor for any infringements of patents or other rights of third parties that may result from its use. Specifications subject to change without notice. No license is granted by implication or otherwise under any patent or patent rights of Analog Devices. Trademarks and registered trademarks are the property of their respective owners.

For price, delivery, and to place orders: Analog Devices, Inc., One Technology Way, P.O. Box 9106, Norwood, MA 02062-9106
Phone: 781-329-4700 • Order online at www.analog.com
Application Support: Phone: 1-800-ANALOG-D



**MMIC VCO w/ HALF FREQUENCY OUTPUT
14.5 - 15.0 GHz**

Frequency vs. Tuning Voltage, Vcc = +4.2V

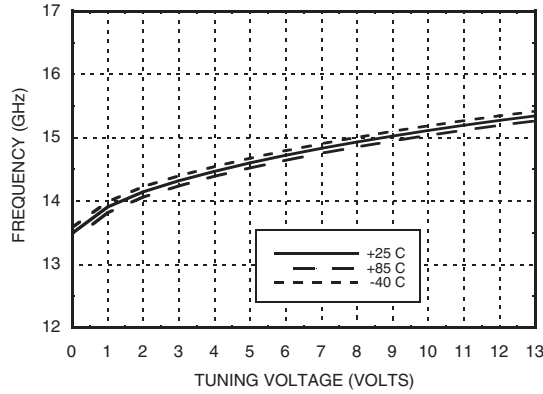

Frequency vs. Tuning Voltage, T = 25°C

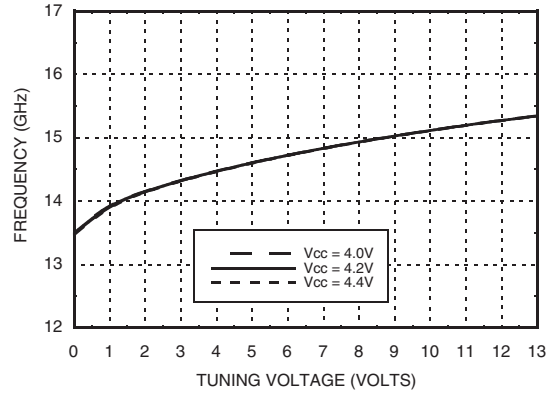

Sensitivity vs. Tuning Voltage, Vcc = +4.2V

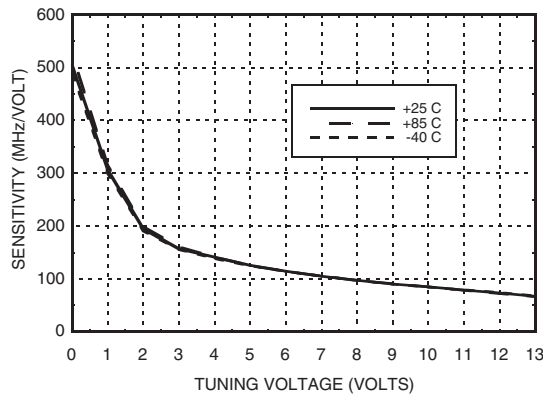

Output Power vs. Tuning Voltage, Vcc = +4.2V

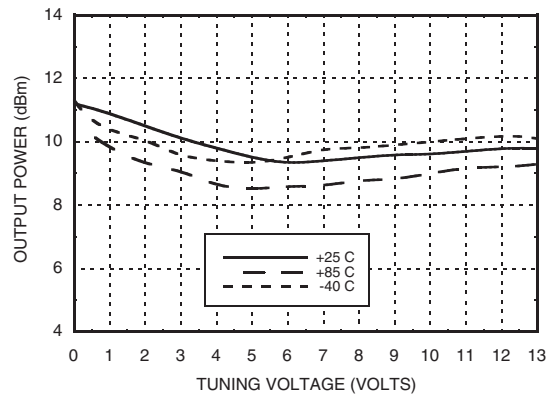

SSB Phase Noise vs. Tuning Voltage

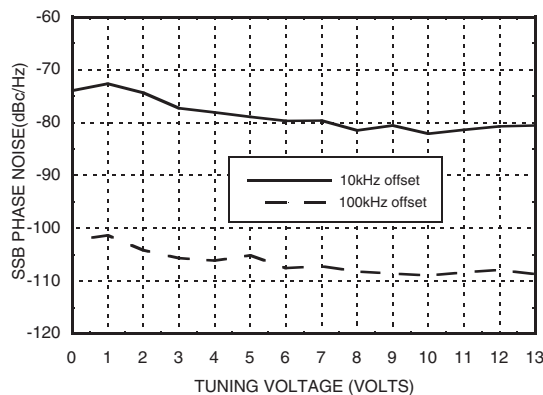

SSB Phase Noise @ Vtune = +5V

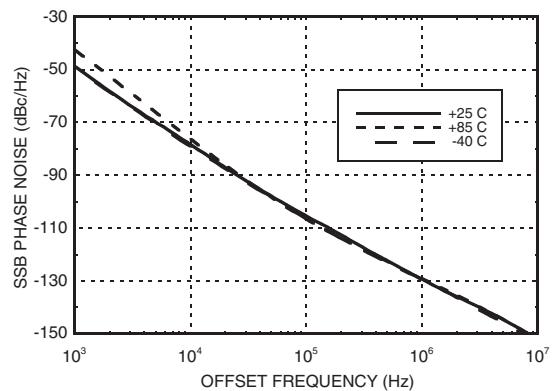

Information furnished by Analog Devices is believed to be accurate and reliable. However, no responsibility is assumed by Analog Devices for its use, nor for any infringements of patents or other rights of third parties that may result from its use. Specifications subject to change without notice. No license is granted by implication or otherwise under any patent or patent rights of Analog Devices. Trademarks and registered trademarks are the property of their respective owners.

For price, delivery, and to place orders: Analog Devices, Inc., One Technology Way, P.O. Box 9106, Norwood, MA 02062-9106 Phone: 781-329-4700 • Order online at www.analog.com Application Support: Phone: 1-800-ANALOG-D

MMIC VCO w/ HALF FREQUENCY OUTPUT 14.5 - 15.0 GHz



RFOUT/2 Frequency vs. Tuning Voltage, Vcc = +4.2V

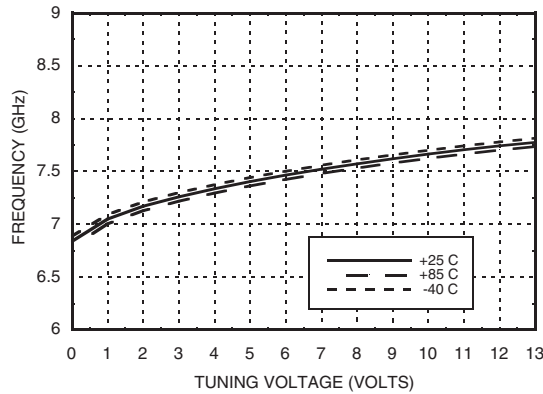

RFOUT/2 Output Power vs. Tuning Voltage, Vcc = +4.2V

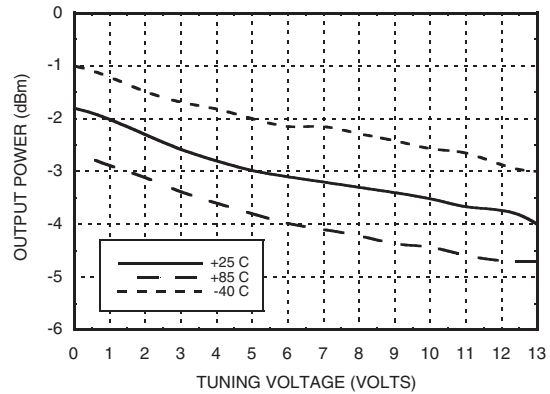

Absolute Maximum Ratings

Vcc	+5.5V
Vtune	0 to 15V
Junction Temperature	135 °C
Continuous Pdiss (T=85 °C) (derate 19.6 mW/C above 85 °C)	1 W
Thermal Resistance (junction to ground paddle)	51 °C/W
Storage Temperature	-65 to +150 °C
Operating Temperature	-40 to +85 °C

Typical Supply Current vs. Vcc

Vcc (V)	Icc (mA)
4.0	140
4.2	150
4.4	160

Note: VCO will operate over full voltage range shown above.



**ELECTROSTATIC SENSITIVE DEVICE
OBSERVE HANDLING PRECAUTIONS**

Package Information

Part Number	Package Body Material	Lead Finish	MSL Rating	Package Marking ^[3]
HMC736LP4	Low Stress Injection Molded Plastic	Sn/Pb Solder	MSL1 ^[1]	H736 XXXX
HMC736LP4E	RoHS-compliant Low Stress Injection Molded Plastic	100% matte Sn	MSL1 ^[2]	H736 XXXX

[1] Max peak reflow temperature of 235 °C

[2] Max peak reflow temperature of 260 °C

[3] 4-Digit lot number XXXX

**MMIC VCO w/ HALF FREQUENCY OUTPUT
14.5 - 15.0 GHz**



Outline Drawing

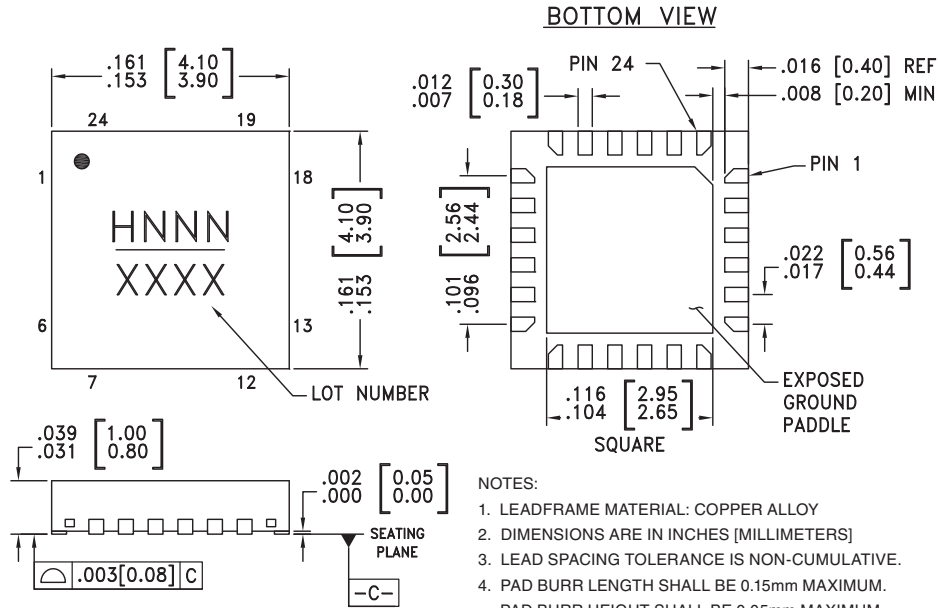

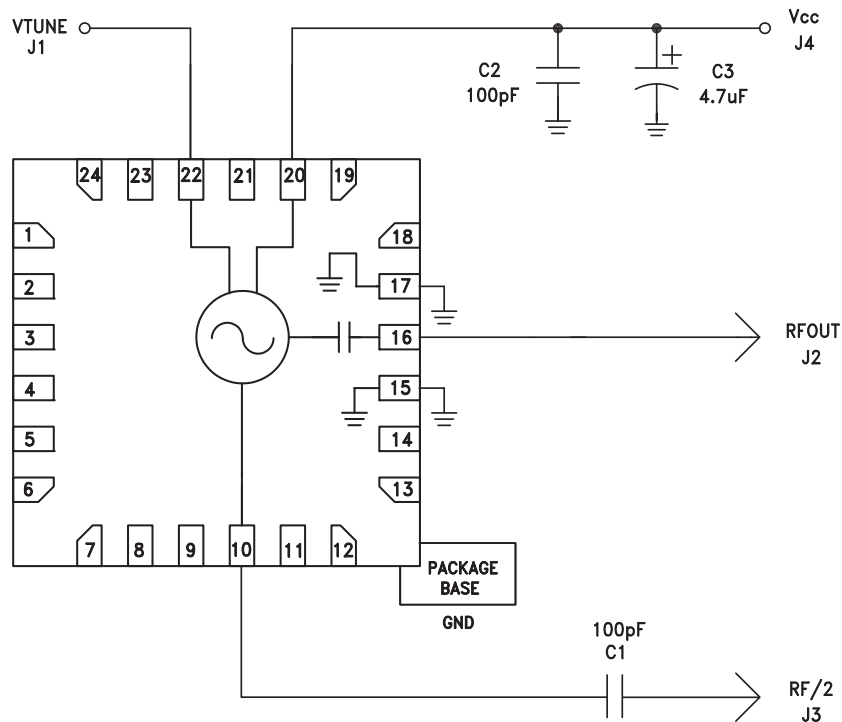

Application Circuit



Information furnished by Analog Devices is believed to be accurate and reliable. However, no responsibility is assumed by Analog Devices for its use, nor for any infringements of patents or other rights of third parties that may result from its use. Specifications subject to change without notice. No license is granted by implication or otherwise under any patent or patent rights of Analog Devices. Trademarks and registered trademarks are the property of their respective owners.

For price, delivery, and to place orders: Analog Devices, Inc., One Technology Way, P.O. Box 9106, Norwood, MA 02062-9106 Phone: 781-329-4700 • Order online at www.analog.com Application Support: Phone: 1-800-ANALOG-D

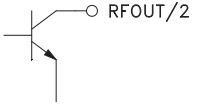
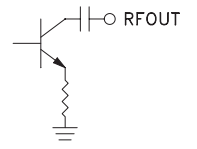
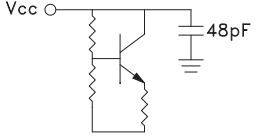
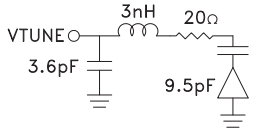
**MMIC VCO w/ HALF FREQUENCY OUTPUT
14.5 - 15.0 GHz**
Pin Descriptions

Pin Number	Function	Description	Interface Schematic
1 - 9, 11 - 14, 18, 19, 21, 23, 24	N/C	No Connection. These pins may be connected to RF/DC ground. Performance will not be affected.	
10	RFOUT/2	Half frequency output (AC coupled). Requires external AC coupling capacitor.	
16	RFOUT	RF output (AC coupled).	
20	Vcc	Supply Voltage, +4.2V	
22	VTUNE	Control voltage and modulation input. Modulation bandwidth dependent on drive source impedance. See "Determining the FM Bandwidth of a Wideband Varactor Tuned VCO" application note.	
15, 17, Paddle	GND	Package bottom has an exposed metal paddle that must be connected to RF/DC ground.	

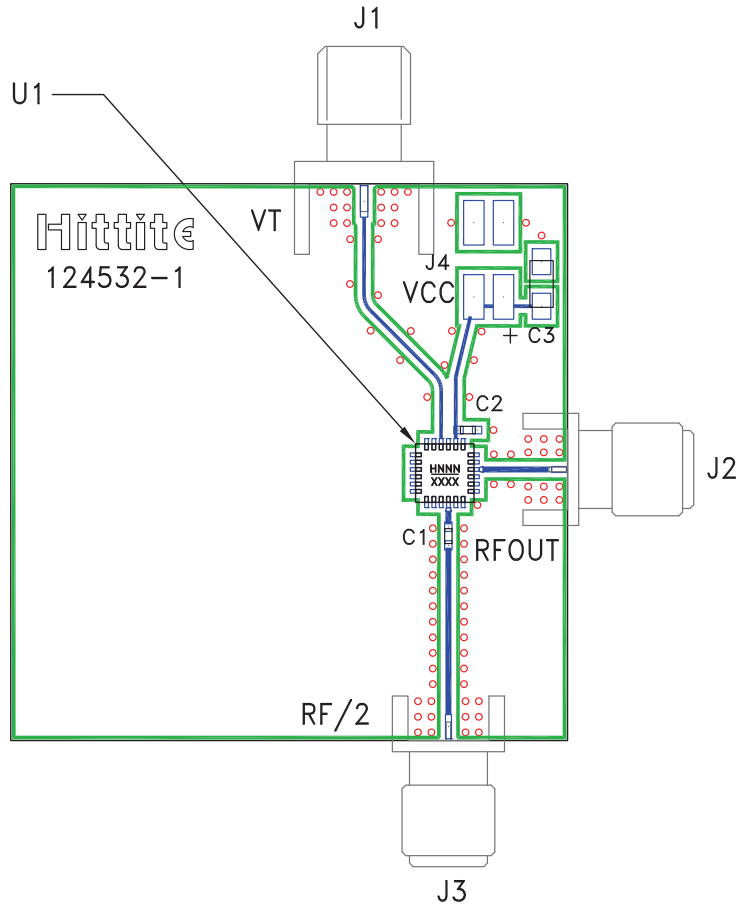
Evaluation PCB

List of Materials for Evaluation PCB 123987 [1]

Item	Description
J1 - J3	PCB Mount SMA RF Connector
J4	2 mm DC Header
C1, C2	100 pF Capacitor, 0402 Pkg.
C3	4.7 µF Tantalum Capacitor
U1	HMC736LP4(E) VCO
PCB [2]	124532 Eval Board

[1] Reference this number when ordering complete evaluation PCB

[2] Circuit Board Material: Arlon 25FR or Rogers 4350

The circuit board used in the application should use RF circuit design techniques. Signal lines should have 50 Ohm impedance while the package ground leads and backside ground paddle should be connected directly to the ground plane similar to that shown. A sufficient number of via holes should be used to connect the top and bottom ground planes. The evaluation circuit board shown is available from Hittite upon request.