



RF360  
Europe GmbH

## Data sheet

SAW Rx filter  
Business Radio

Series/type:	B5058
Ordering code:	B39461B5058Z810
Date:	June 21, 2019
Version:	2.1

RF360 products mentioned within this document are products of RF360 Europe GmbH and other subsidiaries of RF360 Holdings Singapore Pte. Ltd. (collectively, the "RF360 Subsidiaries").

RF360 Europe GmbH, Anzinger Str. 13, München, Germany

© 2019 RF360 Europe GmbH and/or its affiliated companies. All rights reserved.

These materials, including the information contained herein, may be used only for informational purposes by the customer. The RF360 Subsidiaries assume no responsibility for errors or omissions in these materials or the information contained herein. The RF360 Subsidiaries reserve the right to make changes to the product(s) or information contained herein without notice. The materials and information are provided on an AS IS basis, and the RF360 Subsidiaries assume no liability and make no warranty or representation, either expressed or implied, with respect to the materials, or any output or results based on the use, application, or evaluation of such materials, including, without limitation, with respect to the non-infringement of trademarks, patents, copyrights or any other intellectual property rights or other rights of third parties.

No use of this documentation or any information contained herein grants any license, whether express, implied, by estoppel or otherwise, to any intellectual property rights, including, without limitation, to any patents owned by QUALCOMM Incorporated or any of its subsidiaries.

Not to be used, copied, reproduced, or modified in whole or in part, nor its contents revealed in any manner to others without the express written permission of RF360 Europe GmbH.

Qualcomm is a trademark of Qualcomm Incorporated, registered in the United States and other countries. Other product and brand names may be trademarks or registered trademarks of their respective owners.

This technical data may be subject to U.S. and international export, re-export, or transfer ("export") laws. Diversion contrary to U.S. and international law is strictly prohibited.



RF360 Europe GmbH  
A Qualcomm – TDK Joint Venture

## Data sheet

SAW Rx filter  
Business Radio

Series/type:	B5058
Ordering code:	B39461B5058Z810
Date:	June 21, 2019
Version:	2.1

RF360 products mentioned within this document are products of RF360 Europe GmbH and other subsidiaries of RF360 Holdings Singapore Pte. Ltd. (collectively, the "RF360 Subsidiaries").

RF360 Holdings Singapore Pte. Ltd. is a joint venture of Qualcomm Global Trading Pte. Ltd. and EPCOS AG.

RF360 Europe GmbH, Anzinger Str. 13, München, Germany

© 2019 RF360 Europe GmbH and/or its affiliated companies. All rights reserved.

These materials, including the information contained herein, may be used only for informational purposes by the customer. The RF360 Subsidiaries assume no responsibility for errors or omissions in these materials or the information contained herein. The RF360 Subsidiaries reserve the right to make changes to the product(s) or information contained herein without notice. The materials and information are provided on an AS IS basis, and the RF360 Subsidiaries assume no liability and make no warranty or representation, either expressed or implied, with respect to the materials, or any output or results based on the use, application, or evaluation of such materials, including, without limitation, with respect to the non-infringement of trademarks, patents, copyrights or any other intellectual property rights or other rights of third parties.

No use of this documentation or any information contained herein grants any license, whether express, implied, by estoppel or otherwise, to any intellectual property rights, including, without limitation, to any patents owned by QUALCOMM Incorporated or any of its subsidiaries.

Not to be used, copied, reproduced, or modified in whole or in part, nor its contents revealed in any manner to others without the express written permission of RF360 Europe GmbH.

Qualcomm is a trademark of Qualcomm Incorporated, registered in the United States and other countries. Other product and brand names may be trademarks or registered trademarks of their respective owners.

This technical data may be subject to U.S. and international export, re-export, or transfer ("export") laws. Diversion contrary to U.S. and international law is strictly prohibited.

## Table of contents

1	<a href="#">Application</a>	4
2	<a href="#">Features</a>	4
3	<a href="#">Package</a>	5
4	<a href="#">Pin configuration</a>	5
5	<a href="#">Matching circuit</a>	6
6	<a href="#">Characteristics</a>	7
7	<a href="#">Maximum ratings</a>	8
8	<a href="#">Transmission coefficient</a>	9
9	<a href="#">Return loss</a>	10
10	<a href="#">Packing material</a>	11
11	<a href="#">Marking</a>	13
12	<a href="#">Soldering profile</a>	14
13	<a href="#">Annotations</a>	15
14	<a href="#">Cautions and warnings</a>	16
15	<a href="#">Important notes</a>	17

## 1 Application

- Low-loss filter for Business Radio
- Usable pass band 20 MHz
- Unbalanced to unbalanced operation
- No matching required
- Filter impedance 50  $\Omega$

## 2 Features

- Package code QCC8B
- Package size 3.8 $\pm$ 0.15 mm  $\times$  3.8 $\pm$ 0.15 mm
- Package height 1.5 $^{+0.1/-0.15}$  mm
- Approximate weight 0.07 g
- RoHS compatible
- Package for Surface Mount Technology (SMT)
- Ni/Au-plated terminals
- Lead free soldering compatible with J-STD20C
- Electrostatic Sensitive Device (ESD)
- Moisture Sensitivity Level 1 (MSL1)

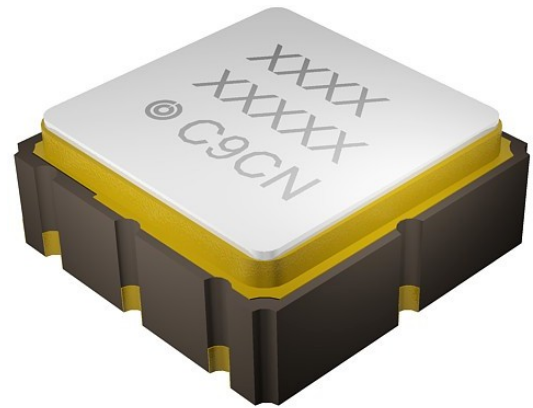

**Figure 1:** Picture of component with example of product marking.

3 Package

BOTTOM VIEW

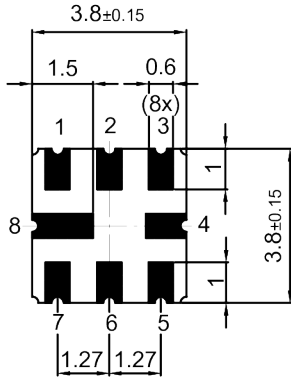

SIDE VIEW

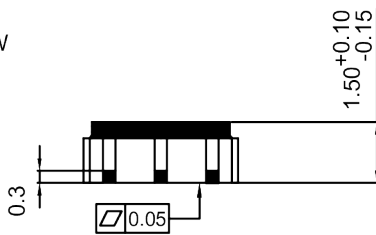

TOP VIEW

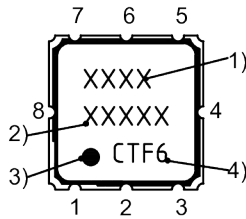

SIDE VIEW

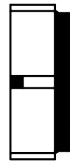

- 1) Device designation
- 2) Last five digits of the lot number
- 3) Marking for pad number 1
- 4) Example of production location and date code

Land pattern  
THRU VIEW

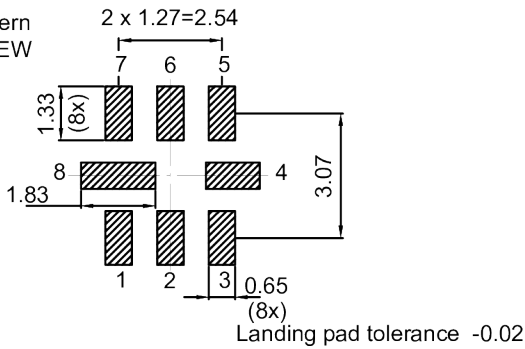

Figure 2: Drawing of package. See Sec. Package information (p. 16).

4 Pin configuration

- 2 Input
- 6 Output
- 1, 3, 4, 5, 7, 8 Ground

5 Matching circuit

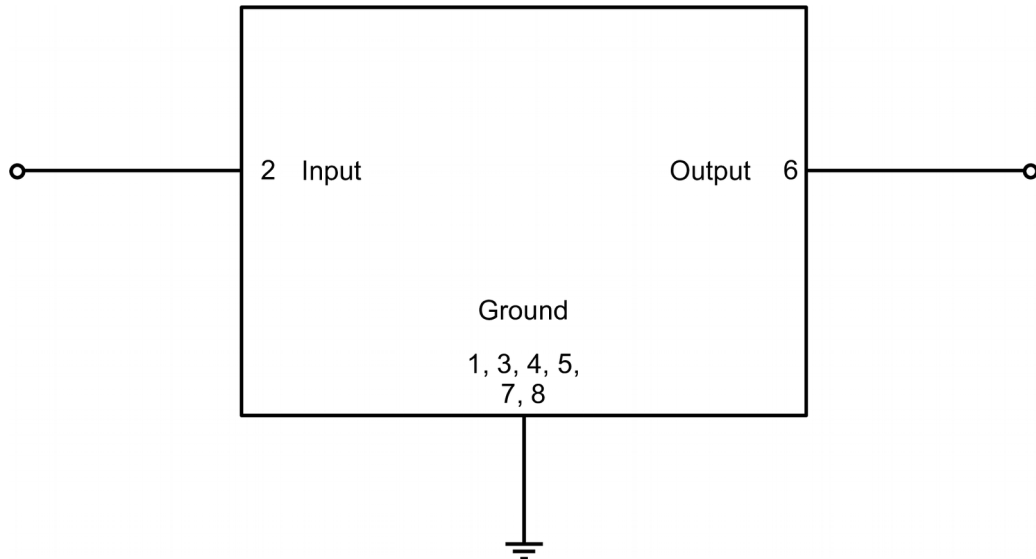

Figure 3: Schematic of matching circuit. No external matching components required.



## 6 Characteristics

Temperature range for specification	$T_{SPEC}$	= -30 °C ... +60 °C
Input terminating impedance	$Z_{IN}$	= 50 $\Omega$
Output terminating impedance	$Z_{OUT}$	= 50 $\Omega$

Characteristics			min. for $T_{SPEC}$	typ. @ +25 °C	max. for $T_{SPEC}$	
<b>Center frequency</b>		$f_C$	—	460	—	MHz
<b>Maximum insertion attenuation</b>	450... 470	MHz	$\alpha_{max}$	—	2.0	3.2 <sup>1)</sup> dB
<b>Amplitude ripple (p-p)</b>	450... 470	MHz	$\Delta\alpha$	—	0.7	2.4 <sup>2)</sup> dB
<b>Minimum return loss</b>			$\alpha$			
@ input port	450... 470	MHz		10	14.5	— dB
@ output port	450... 470	MHz		10	17.5	— dB
<b>Temperature coefficient of frequency</b>			$TC_f$	—	-70.0	— ppm/K
<b>Minimum attenuation</b>			$\alpha_{min}$			
	0.1... 330	MHz		30	42	— dB
	300... 380	MHz		24	34	— dB
	380... 430	MHz		15	23	— dB
	504.825... 524.825	MHz		12	32	— dB
	559.65... 579.65	MHz		28	41	— dB
	669.3... 689.3	MHz		24	37	— dB
	689.3... 1000	MHz		26	34	— dB

<sup>1)</sup> 2.2 dB at 25 °C.

<sup>2)</sup> 1.4 dB at 25 °C.

## 7 Maximum ratings

Operable temperature	$T_{OP} = -40\text{ °C} \dots +125\text{ °C}$	
Storage temperature	$T_{STG}^{1)} = -40\text{ °C} \dots +125\text{ °C}$	
DC voltage	$ V_{DC}  = 5.0\text{ V}$	
ESD voltage	$V_{ESD}^{2)} = 100\text{ V}$	Machine model.
Input power @ input port: 450 ... 470 MHz	$P_{IN} = 10\text{ dBm}$	Continuous wave

<sup>1)</sup> Not valid for packaging material. Please refer to definition of Shelf life (p. 15).

<sup>2)</sup> According to JESD22-A115B (MM – Machine Model), 10 negative & 10 positive pulses.

8 Transmission coefficient

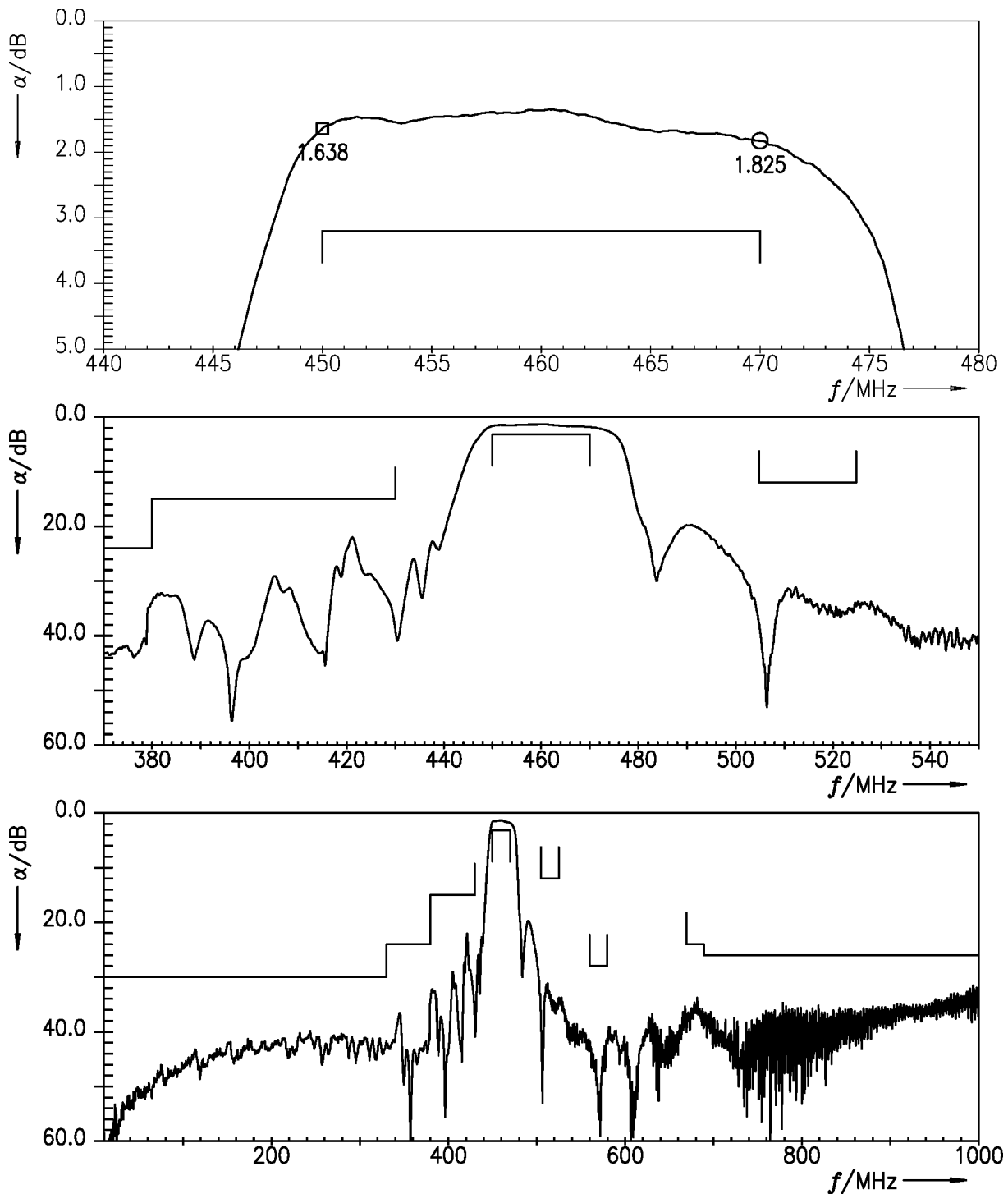

Figure 4: Attenuation.

9 Return loss

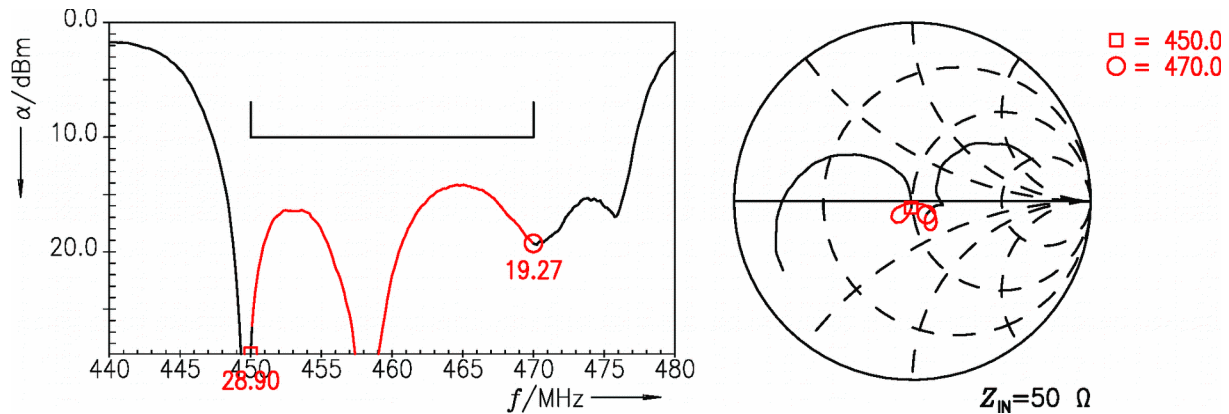

Figure 5: Return loss at input port.

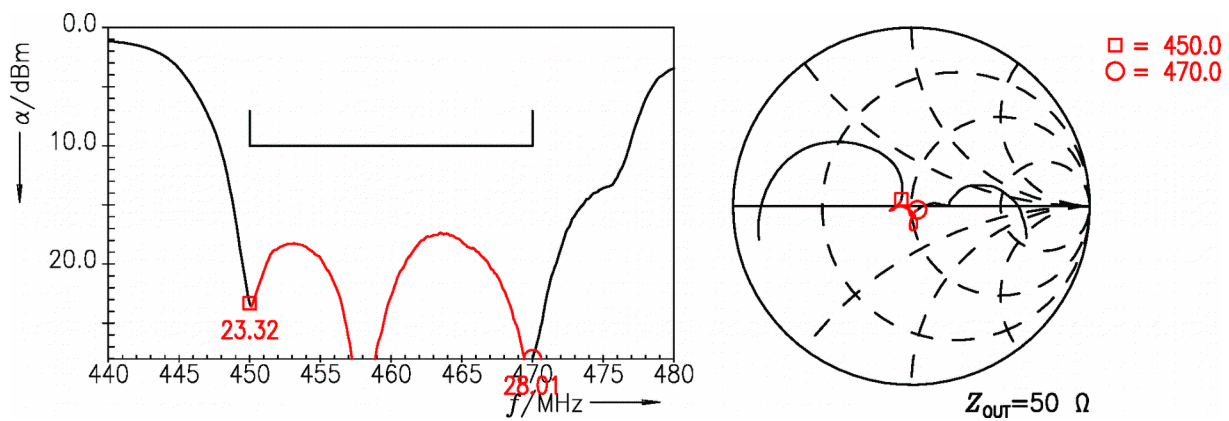
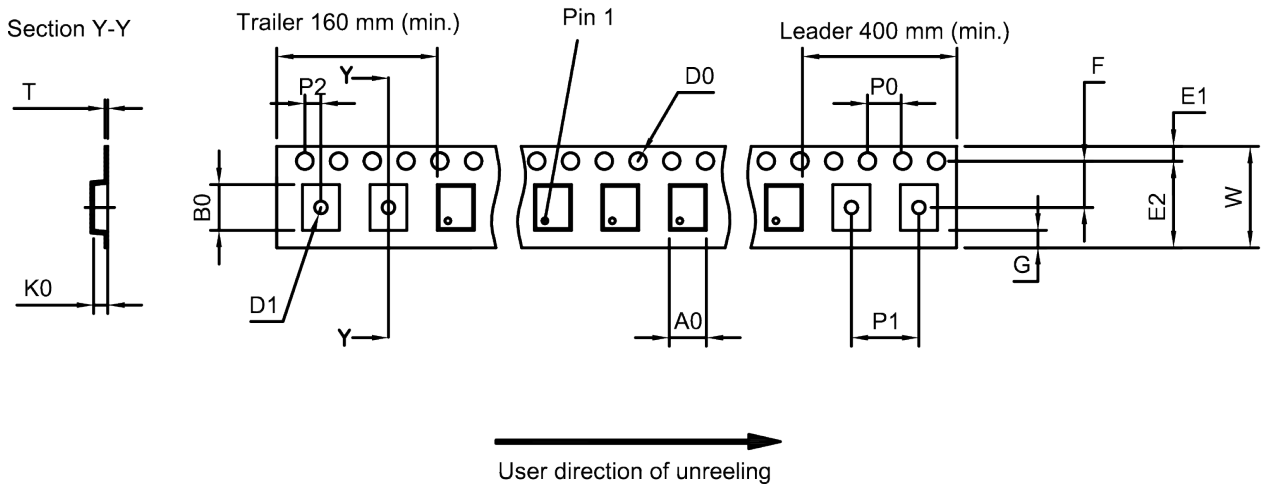

Figure 6: Return loss at output port.

**10 Packing material**

**10.1 Tape**



**Figure 7:** Drawing of tape (first-angle projection) for illustration only and not to scale. The valid tape dimensions are listed in Table 1.

A <sub>0</sub>	4.1±0.1 mm	E <sub>2</sub>	10.25 mm (min.)	P <sub>1</sub>	8.0±0.1 mm
B <sub>0</sub>	4.1±0.1 mm	F	5.5±0.05 mm	P <sub>2</sub>	2.0±0.1 mm
D <sub>0</sub>	1.5+0.1/-0 mm	G	0.75 mm (min.)	T	0.3±0.05 mm
D <sub>1</sub>	1.5 mm (min.)	K <sub>0</sub>	1.8±0.1 mm	W	12.0+0.3/-0.1 mm
E <sub>1</sub>	1.75±0.1 mm	P <sub>0</sub>	4.0±0.1 mm		

**Table 1:** Tape dimensions.

10.2 Reel with diameter of 330 mm

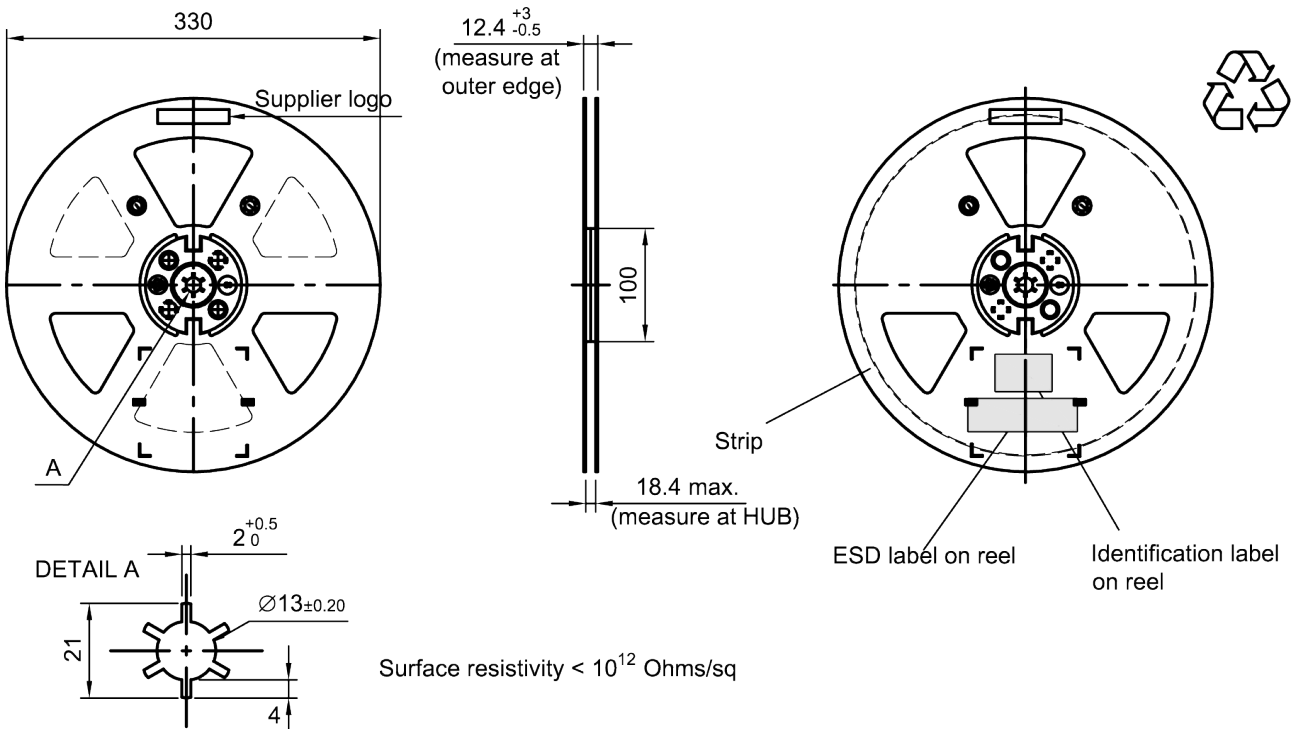
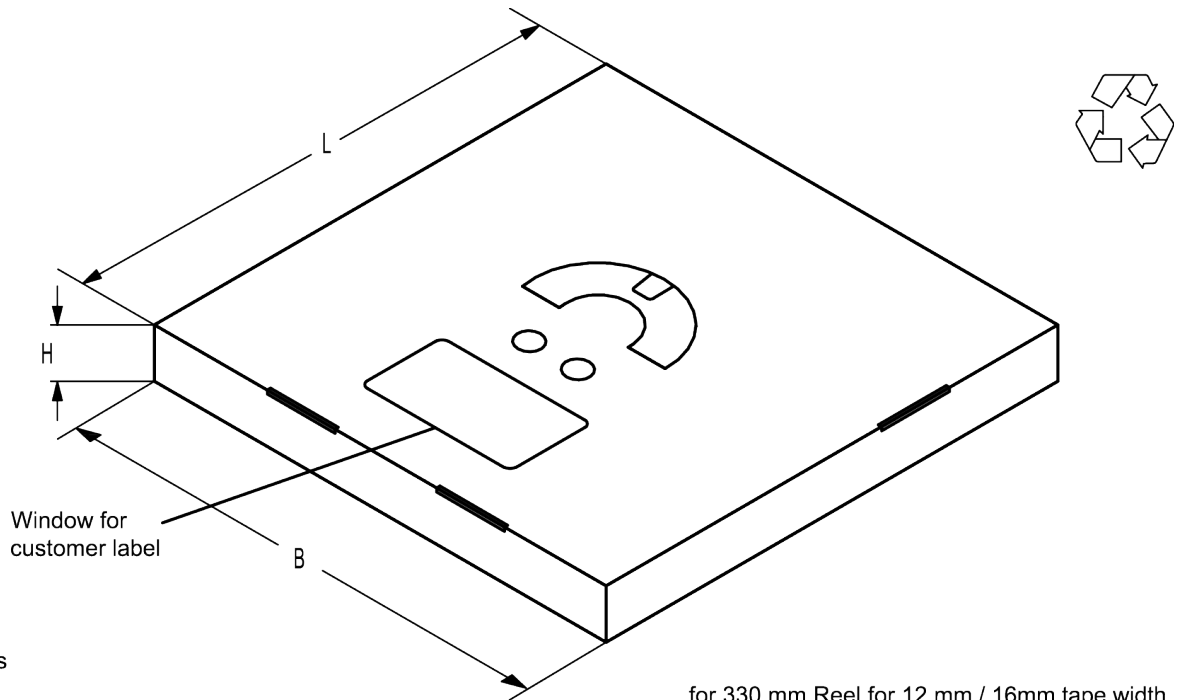

Figure 8: Drawing of reel (first-angle projection) with diameter of 330 mm.



Dimensions

- L = 340
- B = 340
- H = 25

for 330 mm Reel for 12 mm / 16mm tape width SMD packages

Figure 9: Drawing of folding box for reel with diameter of 330 mm.

## 11 Marking

Products are marked with device designation, lot number, as well as production location and date code.

- Device designation: The 4-character device designation of the ordering code is used for the marking.

Example for 4-character device designation: B3xxxxB1234xxxx

- Lot number: The last 5 digits of the lot number are used for the marking.

Example: 12345

- Production location and date code: The production location is Wuxi (encoded in the first character 'C'). The production date code is encoded in the last three characters according to Table 2.

1 <sup>st</sup> digit (day)						2 <sup>nd</sup> digit (year)				3 <sup>rd</sup> digit (month)			
Day	Code	Day	Code	Day	Code	Year	Code	Year	Code	Month	Code	Month	Code
1	1	11	A	21	M	2010	A	2022	P	Jan	1	Jul	7
2	2	12	B	22	N	2011	B	2023	R	Feb	2	Aug	8
3	3	13	C	23	P	2012	C	2024	S	Mar	3	Sep	9
4	4	14	D	24	R	2013	D	2025	T	Apr	4	Oct	0
5	5	15	E	25	S	2014	E	2026	U	May	5	Nov	N
6	6	16	F	26	T	2015	F	2027	V	Jun	6	Dec	D
7	7	17	H	27	U	2016	H	2028	W				
8	8	18	J	28	V	2017	J	2029	X				
9	9	19	K	29	W	2018	K	2030	Z				
10	0	20	L	30	X	2019	L	2031	A				
				31	Z	2020	M	2032	B				
						2021	N	and so on					

**Table 2:** Production date code.

Example of how to decode production location and date code:

Code:           **C T F 6**

Location:       C       → Wuxi

Day:            T       → 26<sup>th</sup>

Year:            F       → 2015

Month:          6       → June

**12 Soldering profile**

The recommended soldering process is in accordance with IEC 60068-2-58 – 3<sup>rd</sup> edit and IPC/JEDEC J-STD-020B.

ramp rate	≤ 3 K/s
preheat	125 °C to 220 °C, 150 s to 210 s, 0.4 K/s to 1.0 K/s
T > 220 °C	30 s to 70 s
T > 230 °C	min. 10 s
T > 245 °C	max. 20 s
T ≥ 255 °C	–
peak temperature $T_{peak}$	250 °C +0/-5 °C
wetting temperature $T_{min}$	230 °C +5/-0 °C for 10 s ± 1 s
cooling rate	≤ 3 K/s
soldering temperature T	measured at solder pads

**Table 3:** Characteristics of recommended soldering profile for lead-free solder (Sn95.5Ag3.8Cu0.7).

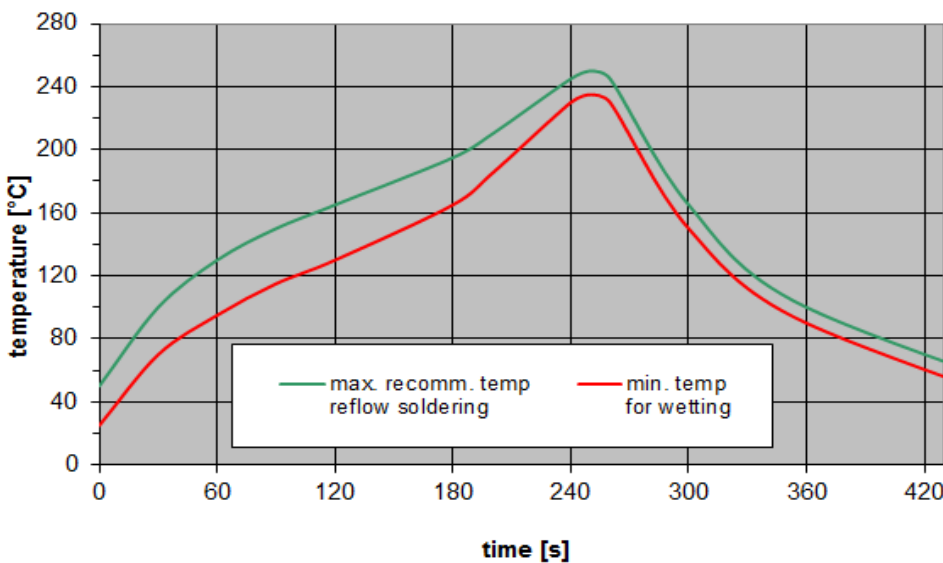

**Figure 10:** Recommended reflow profile for convection and infrared soldering – lead-free solder.



## 13 Annotations

### 13.1 RoHS compatibility

ROHS-compatible means that products are compatible with the requirements according to Art. 4 (substance restrictions) of Directive 2011/65/EU of the European Parliament and of the Council of June 8th, 2011, on the restriction of the use of certain hazardous substances in electrical and electronic equipment ("Directive") with due regard to the application of exemptions as per Annex III of the Directive in certain cases.

### 13.2 Scattering parameters (S-parameters)

The pin/port assignment is available in the headers of the S-parameter files. Please contact your local RF360 sales office.

### 13.3 Shelf life

The shelf life of components is determined by solderability of the package terminals. It is specified as 2 years from manufacturing date assuming the following conditions:

- storage in original packaging and non-aggressive atmosphere,
- storage temperature ranging from  $-25\text{ }^{\circ}\text{C}$  to  $+40\text{ }^{\circ}\text{C}$ , and
- storage humidity with  $\leq 75\%$  r.h. mean annual humidity,  $\leq 95\%$  r.h. for max. 30 days / year, and no dew condensation.

## 14 Cautions and warnings

### 14.1 Display of ordering codes for RF360 products

The ordering code for one and the same product can be represented differently in data sheets, data books, other publications and the website of RF360, or in order-related documents such as shipping notes, order confirmations and product labels. The varying representations of the ordering codes are due to different processes employed and do not affect the specifications of the respective products. Detailed information can be found on the Internet under [www.rf360jv.com/orderingcodes](http://www.rf360jv.com/orderingcodes).

### 14.2 Material information

Due to technical requirements components may contain dangerous substances. For information on the type in question please also contact one of our sales offices.

For information on recycling of tapes and reels please contact one of our sales offices.

### 14.3 Moldability

Before using in overmolding environment, please contact your local RF360 sales office.

### 14.4 Package information

#### Landing area

The printed circuit board (PCB) land pattern (landing area) shown is based on RF360 internal development and empirical data and illustrated for example purposes, only. As customers' SMD assembly processes may have a plenty of variants and influence factors which are not under control or knowledge of RF360, additional careful process development on customer side is necessary and strongly recommended in order to achieve best soldering results tailored to the particular customer needs.

#### Dimensions

Unless otherwise specified all dimensions are understood using unit millimeter (mm).

#### Projection method

Unless otherwise specified first-angle projection is applied.

## 15 Important notes

The following applies to all products named in this publication:

1. Some parts of this publication contain **statements about the suitability of our products for certain areas of application**. These statements are based on our knowledge of typical requirements that are often placed on our products in the areas of application concerned. We nevertheless expressly point out **that such statements cannot be regarded as binding statements about the suitability of our products for a particular customer application**. As a rule, RF360 Europe GmbH and its affiliates are either unfamiliar with individual customer applications or less familiar with them than the customers themselves. For these reasons, it is always ultimately incumbent on the customer to check and decide whether an RF360 product with the properties described in the product specification is suitable for use in a particular customer application.
2. We also point out that **in individual cases, a malfunction of electronic components or failure before the end of their usual service life cannot be completely ruled out in the current state of the art, even if they are operated as specified**. In customer applications requiring a very high level of operational safety and especially in customer applications in which the malfunction or failure of an electronic component could endanger human life or health (e.g. in accident prevention or life-saving systems), it must therefore be ensured by means of suitable design of the customer application or other action taken by the customer (e.g. installation of protective circuitry or redundancy) that no injury or damage is sustained by third parties in the event of malfunction or failure of an electronic component.
3. **The warnings, cautions and product-specific notes must be observed.**
4. In order to satisfy certain technical requirements, **some of the products described in this publication may contain substances subject to restrictions in certain jurisdictions (e.g. because they are classed as hazardous)**. Useful information on this will be found in our Material Data Sheets on the Internet ([www.rf360jv.com/material](http://www.rf360jv.com/material)). Should you have any more detailed questions, please contact our sales offices.
5. We constantly strive to improve our products. Consequently, **the products described in this publication may change from time to time**. The same is true of the corresponding product specifications. Please check therefore to what extent product descriptions and specifications contained in this publication are still applicable before or when you place an order. We also **reserve the right to discontinue production and delivery of products**. Consequently, we cannot guarantee that all products named in this publication will always be available.  
The aforementioned does not apply in the case of individual agreements deviating from the foregoing for customer-specific products.

# Mouser Electronics

Authorized Distributor

Click to View Pricing, Inventory, Delivery & Lifecycle Information:

[Qualcomm RF360:](#)

[B39461B5058Z810](#)