

# 2N6071A/B Series

Preferred Device

## Sensitive Gate Triacs

### Silicon Bidirectional Thyristors

Designed primarily for full-wave AC control applications, such as light dimmers, motor controls, heating controls and power supplies; or wherever full-wave silicon gate controlled solid-state devices are needed. Triac type thyristors switch from a blocking to a conducting state for either polarity of applied anode voltage with positive or negative gate triggering.

#### Features

- Sensitive Gate Triggering Uniquely Compatible for Direct Coupling to TTL, HTL, CMOS and Operational Amplifier Integrated Circuit Logic Functions
- Gate Triggering: 4 Mode - 2N6071A, B; 2N6073A, B; 2N6075A, B
- Blocking Voltages to 600 V
- All Diffused and Glass Passivated Junctions for Greater Parameter Uniformity and Stability
- Small, Rugged, Thermopad Construction for Low Thermal Resistance, High Heat Dissipation and Durability
- Device Marking: Device Type, e.g., 2N6071A, Date Code



**ON Semiconductor®**

<http://onsemi.com>

**TRIACS**  
**4.0 A RMS, 200 – 600 V**

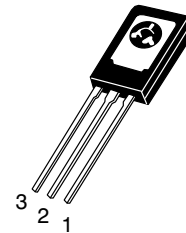
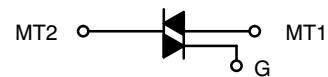

**REAR VIEW  
SHOW TAB**

**TO-225  
CASE 077  
STYLE 5**

#### MARKING DIAGRAM

1. Cathode
2. Anode
3. Gate

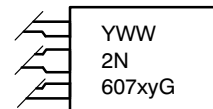

x = 1, 3, 5  
y = A, B  
Y = Year  
WW = Work Week  
G = Pb-Free Package

#### ORDERING INFORMATION

See detailed ordering and shipping information in the package dimensions section on page 7 of this data sheet.

**Preferred** devices are recommended choices for future use and best overall value.

\*For additional information on our Pb-Free strategy and soldering details, please download the ON Semiconductor Soldering and Mounting Techniques Reference Manual, SOLDERRM/D.

## 2N6071A/B Series

### MAXIMUM RATINGS ( $T_J = 25^\circ\text{C}$ unless otherwise noted)

Rating	Symbol	Value	Unit
*Peak Repetitive Off-State Voltage (Note 1) ( $T_J = -40$ to $110^\circ\text{C}$ , Sine Wave, 50 to 60 Hz, Gate Open) 2N6071A,B 2N6073A,B 2N6075A,B	$V_{\text{DRM}}$ , $V_{\text{RRM}}$	200 400 600	V
*On-State RMS Current ( $T_C = 85^\circ\text{C}$ ) Full Cycle Sine Wave 50 to 60 Hz	$I_{\text{T(RMS)}}$	4.0	A
*Peak Non-repetitive Surge Current (One Full cycle, 60 Hz, $T_J = +110^\circ\text{C}$ )	$I_{\text{TSM}}$	30	A
Circuit Fusing Considerations ( $t = 8.3$ ms)	$I^2t$	3.7	$\text{A}^2\text{s}$
*Peak Gate Power (Pulse Width $\leq 1.0$ $\mu\text{s}$ , $T_C = 85^\circ\text{C}$ )	$P_{\text{GM}}$	10	W
*Average Gate Power ( $t = 8.3$ ms, $T_C = 85^\circ\text{C}$ )	$P_{\text{G(AV)}}$	0.5	W
*Peak Gate Voltage (Pulse Width $\leq 1.0$ $\mu\text{s}$ , $T_C = 85^\circ\text{C}$ )	$V_{\text{GM}}$	5.0	V
*Operating Junction Temperature Range	$T_J$	-40 to +110	$^\circ\text{C}$
*Storage Temperature Range	$T_{\text{stg}}$	-40 to +150	$^\circ\text{C}$
Mounting Torque (6-32 Screw) (Note 2)	-	8.0	in. lb.

Stresses exceeding Maximum Ratings may damage the device. Maximum Ratings are stress ratings only. Functional operation above the Recommended Operating Conditions is not implied. Extended exposure to stresses above the Recommended Operating Conditions may affect device reliability.

- $V_{\text{DRM}}$  and  $V_{\text{RRM}}$  for all types can be applied on a continuous basis. Blocking voltages shall not be tested with a constant current source such that the voltage ratings of the devices are exceeded.
- Torque rating applies with use of a compression washer. Mounting torque in excess of 6 in. lb. does not appreciably lower case-to-sink thermal resistance. Main terminal 2 and heatsink contact pad are common.

### THERMAL CHARACTERISTICS

Characteristic	Symbol	Max	Unit
*Thermal Resistance, Junction-to-Case	$R_{\theta\text{JC}}$	3.5	$^\circ\text{C/W}$
Thermal Resistance, Junction-to-Ambient	$R_{\theta\text{JA}}$	75	$^\circ\text{C/W}$
Maximum Lead Temperature for Soldering Purposes 1/8" from Case for 10 Seconds	$T_L$	260	$^\circ\text{C}$

\*Indicates JEDEC Registered Data.

## 2N6071A/B Series

**ELECTRICAL CHARACTERISTICS** ( $T_C = 25^\circ\text{C}$  unless otherwise noted; Electricals apply in both directions)

Characteristic	Symbol	Min	Typ	Max	Unit
----------------	--------	-----	-----	-----	------

**OFF CHARACTERISTICS**

*Peak Repetitive Blocking Current ( $V_D = V_{DRM} = V_{RRM}$ ; Gate Open)	$I_{DRM}$ , $I_{RRM}$	-	-	10 2	$\mu\text{A}$ mA
$T_J = 25^\circ\text{C}$ $T_J = 110^\circ\text{C}$					

**ON CHARACTERISTICS**

*Peak On-State Voltage (Note 3) ( $I_{TM} = \pm 6.0$ A Peak)	$V_{TM}$	-	-	2	V
*Gate Trigger Voltage (Continuous DC), All Quadrants (Main Terminal Voltage = 12 Vdc, $R_L = 100 \Omega$ , $T_J = -40^\circ\text{C}$ )	$V_{GT}$	-	1.4	2.5	V
Gate Non-Trigger Voltage, All Quadrants (Main Terminal Voltage = 12 Vdc, $R_L = 100 \Omega$ , $T_J = 110^\circ\text{C}$ )	$V_{GD}$	0.2	-	-	V
*Holding Current (Main Terminal Voltage = 12 Vdc, Gate Open, Initiating Current = $\pm 1$ Adc)	$I_H$	-	-	30 15	mA
$T_J = -40^\circ\text{C}$ $T_J = 25^\circ\text{C}$					
Turn-On Time ( $I_{TM} = 14$ Adc, $I_{GT} = 100$ mAdc)	$t_{gt}$	-	1.5	-	$\mu\text{s}$

**QUADRANT  
(Maximum Value)**

	Type	$I_{GT} @ T_J$	I mA	II mA	III mA	IV mA
Gate Trigger Current (Continuous DC) (Main Terminal Voltage = 12 Vdc, $R_L = 100 \Omega$ )	2N6071A 2N6073A 2N6075A	+25°C	5	5	5	10
		-40°C	20	20	20	30
	2N6071B 2N6073B 2N6075B	+25°C	3	3	3	5
		-40°C	15	15	15	20

**DYNAMIC CHARACTERISTICS**

Critical Rate of Rise of Commutation Voltage @ $V_{DRM}$ , $T_J = 85^\circ\text{C}$ , Gate Open, $I_{TM} = 5.7$ A, Exponential Waveform, Commutating $di/dt = 2.0$ A/ms	$dv/dt(c)$	-	5	-	V/ $\mu\text{s}$
---	------------	---	---	---	------------------

3. Pulse Test: Pulse Width  $\leq 2.0$  ms, Duty Cycle  $\leq 2\%$ .  
\*Indicates JEDEC Registered Data.

**SAMPLE APPLICATION:  
TTL-SENSITIVE GATE 4 AMPERE TRIAC  
TRIGGERS IN MODES II AND III**

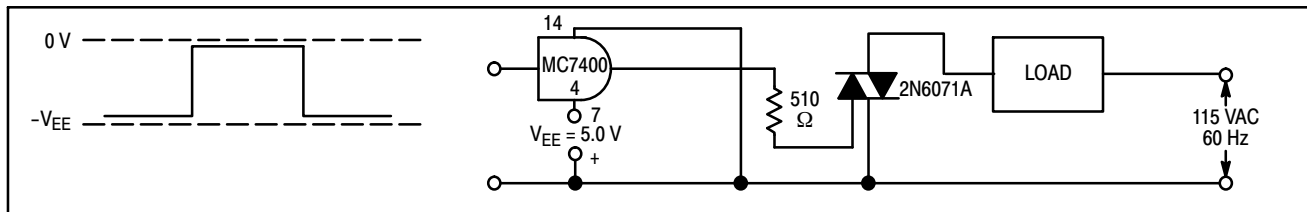

- Trigger devices are recommended for gating on Triacs. They provide:
1. Consistent predictable turn-on points.
  2. Simplified circuitry.
  3. Fast turn-on time for cooler, more efficient and reliable operation.

## 2N6071A/B Series

### Voltage Current Characteristic of Triacs (Bidirectional Device)

Symbol	Parameter
$V_{DRM}$	Peak Repetitive Forward Off State Voltage
$I_{DRM}$	Peak Forward Blocking Current
$V_{RRM}$	Peak Repetitive Reverse Off State Voltage
$I_{RRM}$	Peak Reverse Blocking Current
$V_{TM}$	Maximum On State Voltage
$I_H$	Holding Current

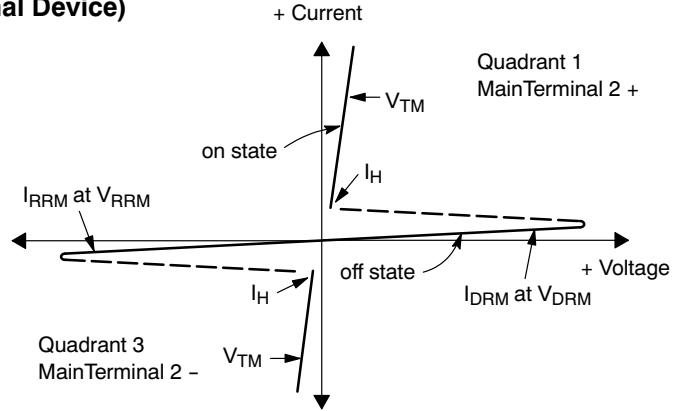

### Quadrant Definitions for a Triac

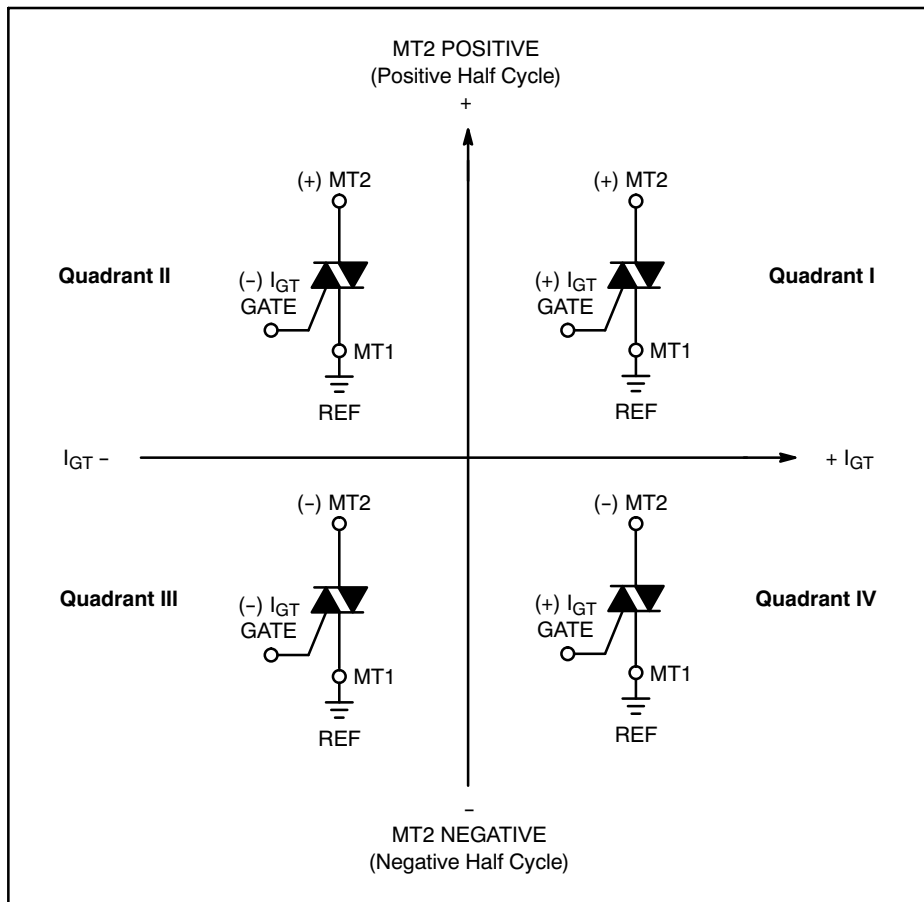

All polarities are referenced to MT1.  
With in-phase signals (using standard AC lines) quadrants I and III are used.

### SENSITIVE GATE LOGIC REFERENCE

IC Logic Functions	Firing Quadrant			
	I	II	III	IV
TTL		2N6071A Series	2N6071A Series	
HTL		2N6071A Series	2N6071A Series	
CMOS (NAND)	2N6071B Series			2N6071B Series
CMOS (Buffer)		2N6071B Series	2N6071B Series	
Operational Amplifier	2N6071A Series			2N6071A Series
Zero Voltage Switch		2N6071A Series	2N6071A Series	

## 2N6071A/B Series

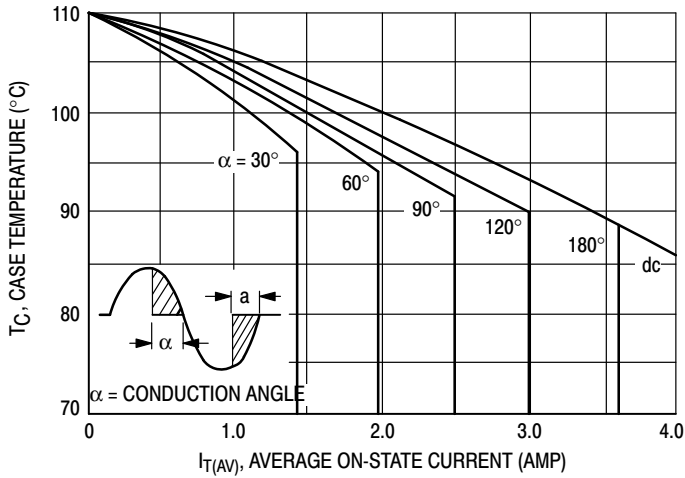

**Figure 1. Average Current Derating**

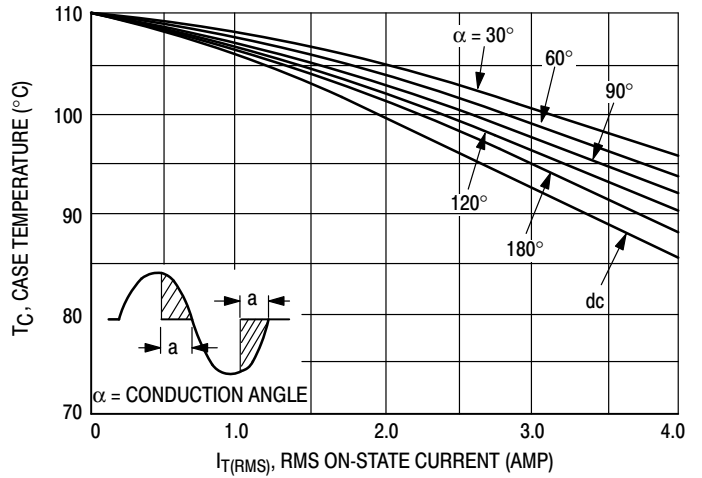

**Figure 2. RMS Current Derating**

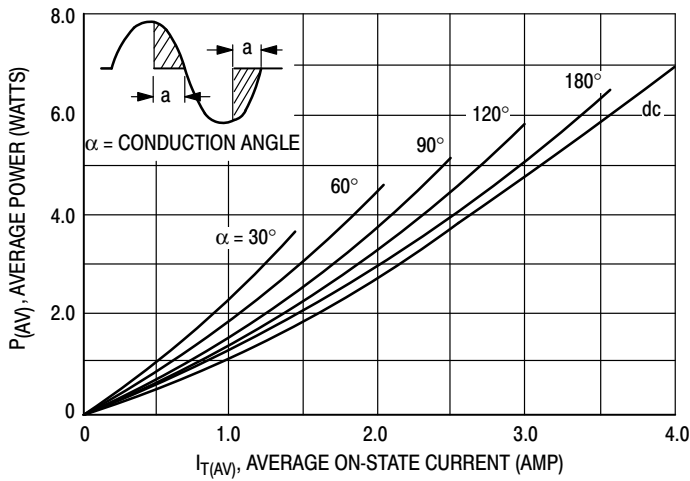

**Figure 3. Power Dissipation**

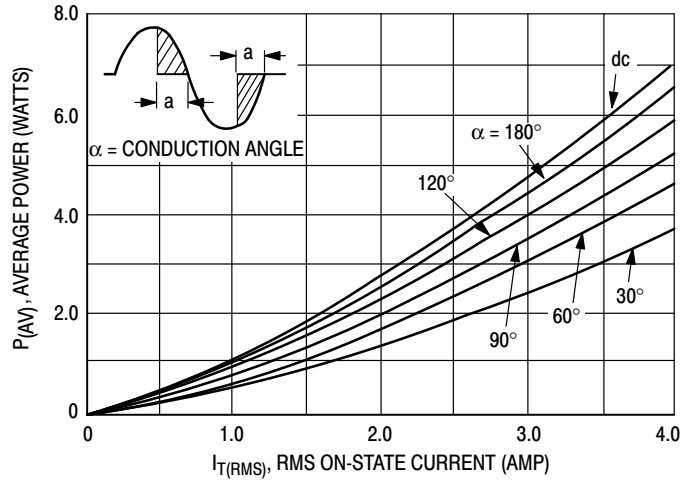

**Figure 4. Power Dissipation**

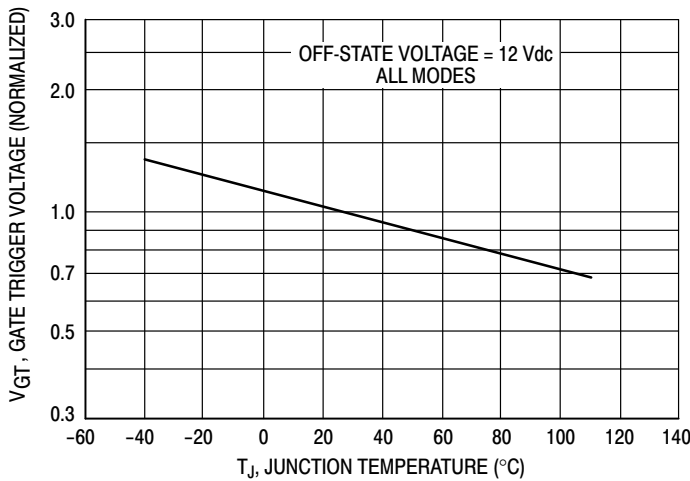

**Figure 5. Typical Gate-Trigger Voltage**

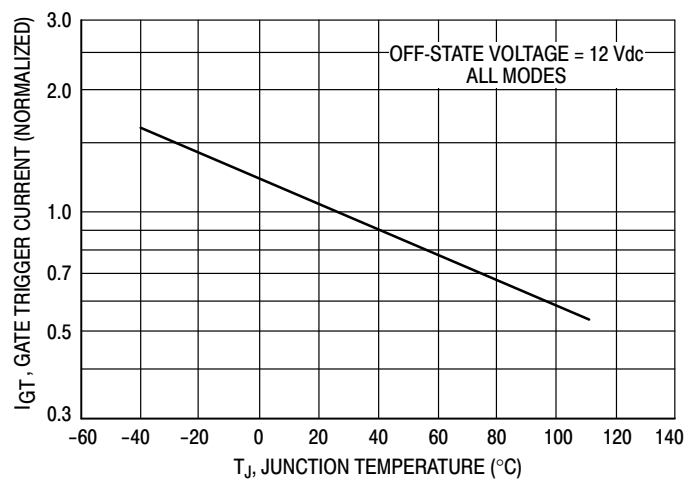

**Figure 6. Typical Gate-Trigger Current**

# 2N6071A/B Series



Figure 7. Maximum On-State Characteristics

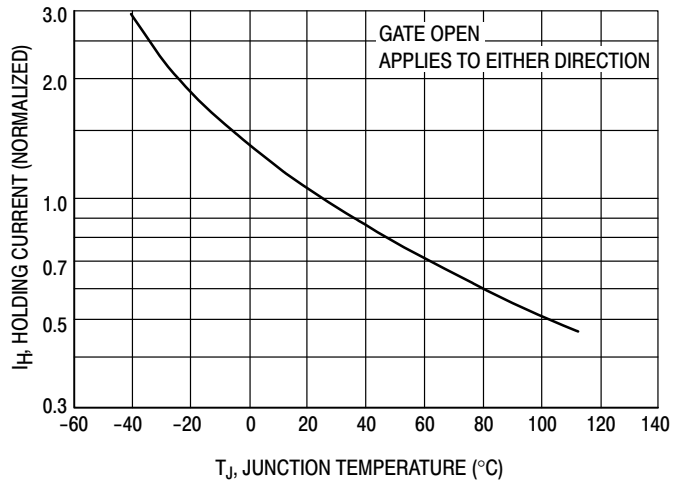

Figure 8. Typical Holding Current



Figure 9. Maximum Allowable Surge Current

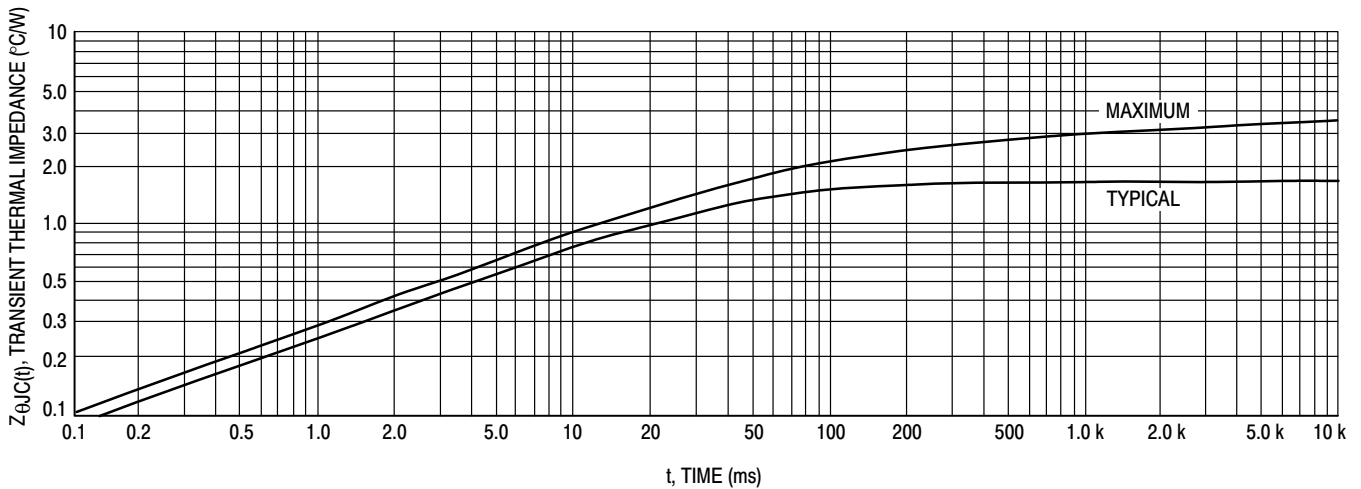

Figure 10. Thermal Response

## 2N6071A/B Series

### ORDERING INFORMATION

Device	Package	Shipping†
2N6071A	TO-225	500 Units / Box
2N6071AG	TO-225 (Pb-Free)	
2N6071AT	TO-225	50 Units / Tube 2000 Units / Box
2N6071ATG	TO-225 (Pb-Free)	50 Units / Tube 2000 Units / Box
2N6071B	TO-225	500 Units / Box
2N6071BG	TO-225 (Pb-Free)	
2N6071BT	TO-225	50 Units / Tube 2000 Units / Box
2N6071BTG	TO-225 (Pb-Free)	50 Units / Tube 2000 Units / Box
2N6073A	TO-225	500 Units / Box
2N6073AG	TO-225 (Pb-Free)	
2N6073B	TO-225	
2N6073BG	TO-225 (Pb-Free)	
2N6075A	TO-225	
2N6075AG	TO-225 (Pb-Free)	
2N6075B	TO-225	
2N6075BG	TO-225 (Pb-Free)	

†For information on tape and reel specifications, including part orientation and tape sizes, please refer to our Tape and Reel Packaging Specifications Brochure, BRD8011/D.

# 2N6071A/B Series

## PACKAGE DIMENSIONS

TO-225  
CASE 77-09  
ISSUE Z



NOTES:

1. DIMENSIONING AND TOLERANCING PER ANSI Y14.5M, 1982.
2. CONTROLLING DIMENSION: INCH.
3. 077-01 THRU -08 OBSOLETE, NEW STANDARD 077-09.

DIM	INCHES		MILLIMETERS	
	MIN	MAX	MIN	MAX
A	0.425	0.435	10.80	11.04
B	0.295	0.305	7.50	7.74
C	0.095	0.105	2.42	2.66
D	0.020	0.026	0.51	0.66
F	0.115	0.130	2.93	3.30
G	0.094 BSC		2.39 BSC	
H	0.050	0.095	1.27	2.41
J	0.015	0.025	0.39	0.63
K	0.575	0.655	14.61	16.63
M	5° TYP		5° TYP	
Q	0.148	0.158	3.76	4.01
R	0.045	0.065	1.15	1.65
S	0.025	0.035	0.64	0.88
U	0.145	0.155	3.69	3.93
V	0.040	---	1.02	---

STYLE 5:

1. MT 1
2. MT 2
3. GATE

ON Semiconductor and are registered trademarks of Semiconductor Components Industries, LLC (SCILLC). SCILLC reserves the right to make changes without further notice to any products herein. SCILLC makes no warranty, representation or guarantee regarding the suitability of its products for any particular purpose, nor does SCILLC assume any liability arising out of the application or use of any product or circuit, and specifically disclaims any and all liability, including without limitation special, consequential or incidental damages. "Typical" parameters which may be provided in SCILLC data sheets and/or specifications can and do vary in different applications and actual performance may vary over time. All operating parameters, including "Typicals" must be validated for each customer application by customer's technical experts. SCILLC does not convey any license under its patent rights nor the rights of others. SCILLC products are not designed, intended, or authorized for use as components in systems intended for surgical implant into the body, or other applications intended to support or sustain life, or for any other application in which the failure of the SCILLC product could create a situation where personal injury or death may occur. Should Buyer purchase or use SCILLC products for any such unintended or unauthorized application, Buyer shall indemnify and hold SCILLC and its officers, employees, subsidiaries, affiliates, and distributors harmless against all claims, costs, damages, and expenses, and reasonable attorney fees arising out of, directly or indirectly, any claim of personal injury or death associated with such unintended or unauthorized use, even if such claim alleges that SCILLC was negligent regarding the design or manufacture of the part. SCILLC is an Equal Opportunity/Affirmative Action Employer. This literature is subject to all applicable copyright laws and is not for resale in any manner.

### PUBLICATION ORDERING INFORMATION

**LITERATURE FULFILLMENT:**  
Literature Distribution Center for ON Semiconductor  
P.O. Box 5163, Denver, Colorado 80217 USA  
**Phone:** 303-675-2175 or 800-344-3860 Toll Free USA/Canada  
**Fax:** 303-675-2176 or 800-344-3867 Toll Free USA/Canada  
**Email:** orderlit@onsemi.com

**N. American Technical Support:** 800-282-9855 Toll Free  
USA/Canada  
**Europe, Middle East and Africa Technical Support:**  
Phone: 421 33 790 2910  
**Japan Customer Focus Center**  
Phone: 81-3-5773-3850

**ON Semiconductor Website:** [www.onsemi.com](http://www.onsemi.com)  
**Order Literature:** <http://www.onsemi.com/orderlit>  
For additional information, please contact your local Sales Representative





Поставка электронных компонентов

**Юридический адрес организации:**  
198099, г. Санкт-Петербург, ул. Калинина, дом 2, кор. 4, лит А.  
**Фактический адрес организации:**  
198099, г. Санкт-Петербург, ул. Калинина, дом 2, кор. 4, лит А.  
ИНН 780277764  
КПП 780501001  
Р/С 40702810422510004035 ФАКБ "АБСОЛЮТ БАНК" (ЗАО) в Санкт-Петербурге К/С 30101810900000000703  
БИК 044030703  
**Телефон:** 8 (812) 309-44-11 (многоканальный)  
**Факс:** 8 (812) 309-44-11  
**Электронная почта:** [sales@timechips.ru](mailto:sales@timechips.ru)  
**Сайт:** [timechips.ru](http://timechips.ru)

## Информационное письмо

Компания «ТаймЧипс» - одна из наиболее динамично развивающихся компаний в сфере поставок электронных компонентов. Мы поставляем широкую номенклатуру электронных компонентов отечественных и импортных производителей, как напрямую, так и с крупных мировых складов, позволяющих охватить выборочную номенклатуру более 300 брендов, а также специализируемся на поставках дисплеев и является официальным дистрибьютором компании Shenzhen Startek Electronic Technology Co, на территории Российской Федерации.

Наличие собственной логистики позволяет в кратчайшие сроки доставлять товар нашим клиентам. В нашей компании имеется Конструкторский отдел, где наши специалисты проводят технические консультации клиентов, квалифицированную поддержку и помощь российским разработчикам. Осуществляем Поставки импортной продукции под контролем ВП МО РФ, на предприятия Оборонно-промышленного комплекса России. Система менеджмента качества компании соответствует требованиям ГОСТ ISO 9001-2011.

Благодаря нацеленности на результат, мы уверенно занимаем новые позиции на рынке, заинтересовывая Клиента не только актуальными ценами и гибким подходом, но и постоянным вниманием.

**Миссия** – обеспечение долгосрочного и взаимовыгодного партнерства с клиентами.

**Наша цель** – Обеспечение клиентам самого широкого ассортимента электронных компонентов и бесперебойности поставок.

**Мы - это развитие! Мы задаем темп! Мы разные, но вместе! Мы работаем для вас!**

Так же имеем прямые поставки от производителей:

TAI-SAW Пав-компоненты ([www.taisaw.com](http://www.taisaw.com))

TRANSCOM СВЧ-компоненты ([www.transcominc.com.tw](http://www.transcominc.com.tw))

Mini Circuits ВЧ-СВЧ-компоненты ([minicircuits.com](http://minicircuits.com))

SAMTEC- разъемы ([www.samtec.com](http://www.samtec.com))

4Star Разъемы РЧ (Даташиты по продукции 4Star, которые Вы сможете загрузить по этой ссылке: <https://yadi.sk/i/tPjnmGGrpmbYj>)

ULNION Преобразователи напряжения ([converterdc.com/](http://converterdc.com/))

**Отличные рекомендации на рынке, уверенность в качестве поставляемой продукции делают нас надежными партнерами для наших клиентов.**

**«ТаймЧипс» - это:**

- Гарантия качества поставляемой продукции;
- Широкий ассортимент;
- Минимальные сроки поставок;
- Техническая поддержка;
- Подбор комплектации;
- Индивидуальный подход;
- Гибкие цены.

**Модули, микросхемы, пассивные компоненты, Xilinx (XC), Altera (EP,EPF, EPM) и силовая электроника** – это наши ведущие позиции, на поставку которых мы гарантированно дадим Вам самые выгодные предложения!

**В структуру компании так же входит конструкторский отдел, который помогает разработчикам и конструкторам в решении следующих задач:**

- Оценка стоимости проекта по компонентам;
- Подбор оптимального решения при выборе компонента;
- Подбор аналогов;
- Техническая поддержка;
- Консультации у производителей;
- Поставка прототипов;

*С Уважением, Чернов Павел.*

*Руководитель отдела продаж ООО "ТАЙМЧИПС"*

*Официальный дистрибьютор Shenzhen Startek Electronic Technology Co.,Ltd в России (USB Display Modules , LED Displays, Serial Modules).*

<http://www.timechips.ru/>

<http://lcd-timechips.ru/>

**Телефон: +7 (812) 309-44-11 доб. 141**

**Факс: +7 (812) 309-44-11 доб. 152**

**Моб. Тел. +7 (905) 232-40-65**

**Skype: time.chips5**

**Электронная почта: [manager1@timechips.ru](mailto:manager1@timechips.ru)**

---