

Description: 2.4/5GHz Dualband WiFi SMT  
Antenna

Series: Embedded Antenna

**PART NUMBER: W3715**



### Features:

- Frequency: 2.4-2.5/4.9-6GHz
- Gain: 3.7/5.5dBi
- Size: 11 x 7 x 16 mm
- SMT compatible
- Packing: Tape&Reel
- RoHS compliant

### Applications:

- WiFi, ISM 2.4/5GHz
- Bluetooth, Zigbee, BLE
- DSRC 5.925GHz
- IoT and M2M devices
- Portable Electronics
- Security, Transportation

All dimensions are in mm / inches

Issue: 1812

In the effort to improve our products, we reserve the right to make changes judged to be necessary.

CONFIDENTIAL AND PROPRIETARY INFORMATION

This document contains confidential and proprietary information of Pulse Electronics, Inc. (Pulse) and is protected by copyright, trade secret and other state and federal laws. Its receipt or possession does not convey any rights to reproduce, disclose its contents, or to manufacture, use or sell anything it may describe. Reproduction, disclosure or use without specific written authorization of Pulse is strictly forbidden.

For more information:

Pulse Worldwide Headquarters  
12220 World Trade Drive  
San Diego, CA 92128  
USA  
Tel: 1-858-674-8100

Pulse/Larsen Antennas  
18110 SE 34<sup>th</sup> St Bldg 2 Suite 250  
Vancouver, WA 98683  
USA  
Tel: 1-360-944-7551

Europe Headquarters  
Pulse GmbH & Do, KG  
Zeppelinstrasse 15  
Herrenberg, Germany  
Tel: 49 7032 7806 0

Pulse (Suzhou) Wireless Products Co, Inc.  
99 Huo Ju Road(#29 Bldg,4<sup>th</sup> Phase  
Suzhou New District  
Jiangsu Province, Suzhou 215009 PR China  
Tel: 86 512 6807 9998



Description: 2.4/5GHz Dualband WiFi SMT  
Antenna

Series: Embedded Antenna

**PART NUMBER: W3715**

## ELECTRICAL SPECIFICATIONS

Frequency	2.4-2.5GHz, 4.9-6GHz
Nominal Impedance	50Ω
VSWR	2:1
Peak Gain (2.4-2.5GHz)	3.7dBi +/- 1 dB
Peak Gain (4.9-6GHz)	5.5dBi +/- 1 dB
Efficiency	74%
Power withstanding	5W
Radiation Pattern	Omni

Issue: 1812

In the effort to improve our products, we reserve the right to make changes judged to be necessary.

CONFIDENTIAL AND PROPRIETARY INFORMATION

This document contains confidential and proprietary information of Pulse Electronics, Inc. (Pulse) and is protected by copyright, trade secret and other state and federal laws. Its receipt or possession does not convey any rights to reproduce, disclose its contents, or to manufacture, use or sell anything it may describe. Reproduction, disclosure or use without specific written authorization of Pulse is strictly forbidden.

Description: 2.4/5GHz Dualband WiFi SMT Antenna

Series: Embedded Antenna

**PART NUMBER: W3715**

### MECHANICAL SPECIFICATIONS

Material	SUS304
Thickness	0.5 mm
Finish	Ni plating 1-3 um
Weight	0.56 g
Size(L X W X H)	11(0.43)X 7(0.28) X 16(0.63) mm(inch)
Fixing system	SMT

### ENVIRONMENTAL SPECIFICATIONS

Operating temperature	-40/+85 ° C
-----------------------	-------------

Description: 2.4/5GHz Dualband WiFi SMT Antenna

Series: Embedded Antenna

**PART NUMBER: W3715**

**MECHANICAL DRAWING**

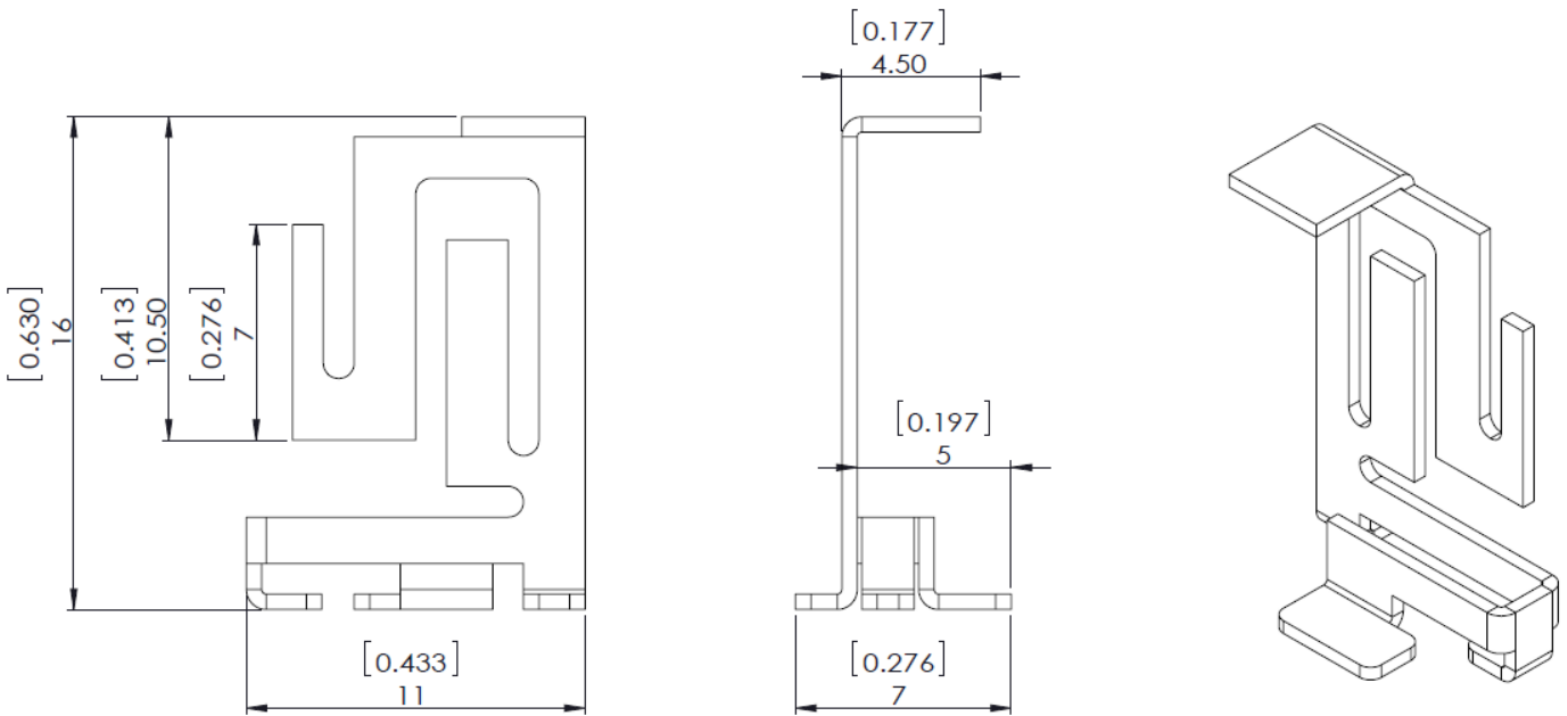

Issue: 1812

In the effort to improve our products, we reserve the right to make changes judged to be necessary.

CONFIDENTIAL AND PROPRIETARY INFORMATION

This document contains confidential and proprietary information of Pulse Electronics, Inc. (Pulse) and is protected by copyright, trade secret and other state and federal laws. Its receipt or possession does not convey any rights to reproduce, disclose its contents, or to manufacture, use or sell anything it may describe. Reproduction, disclosure or use without specific written authorization of Pulse is strictly forbidden.

Description: 2.4/5GHz Dualband WiFi SMT Antenna

Series: Embedded Antenna

**PART NUMBER: W3715**

**OTHER SPECIFICATIONS**

**PCB LAYOUT:**

1, PCB material, FR4, size, 180X120X1mm

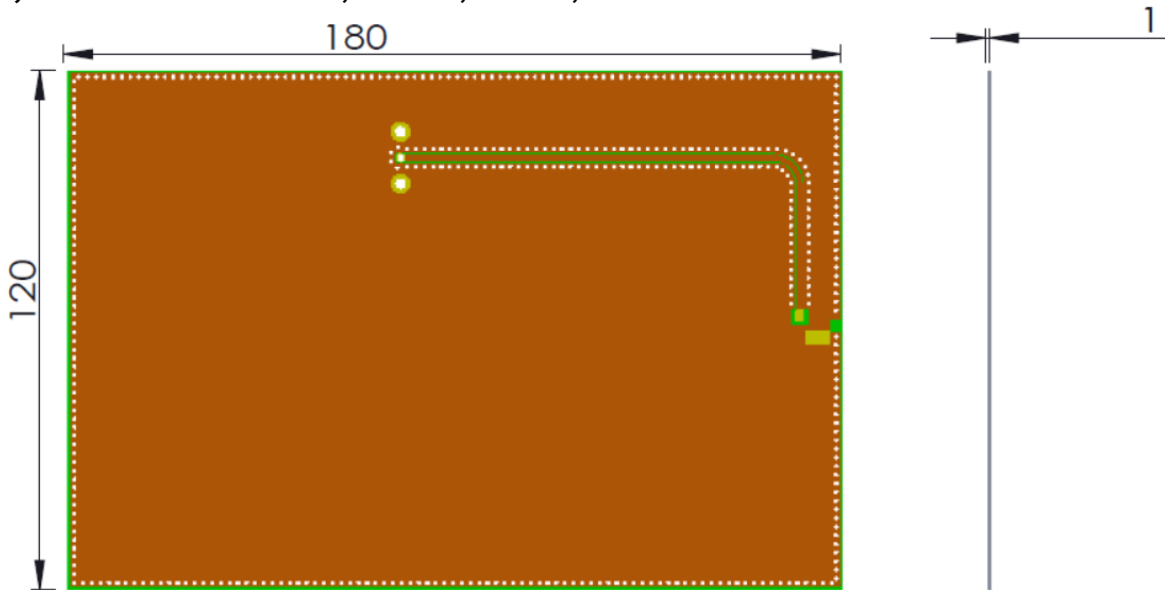

2, Clearance area (Top)

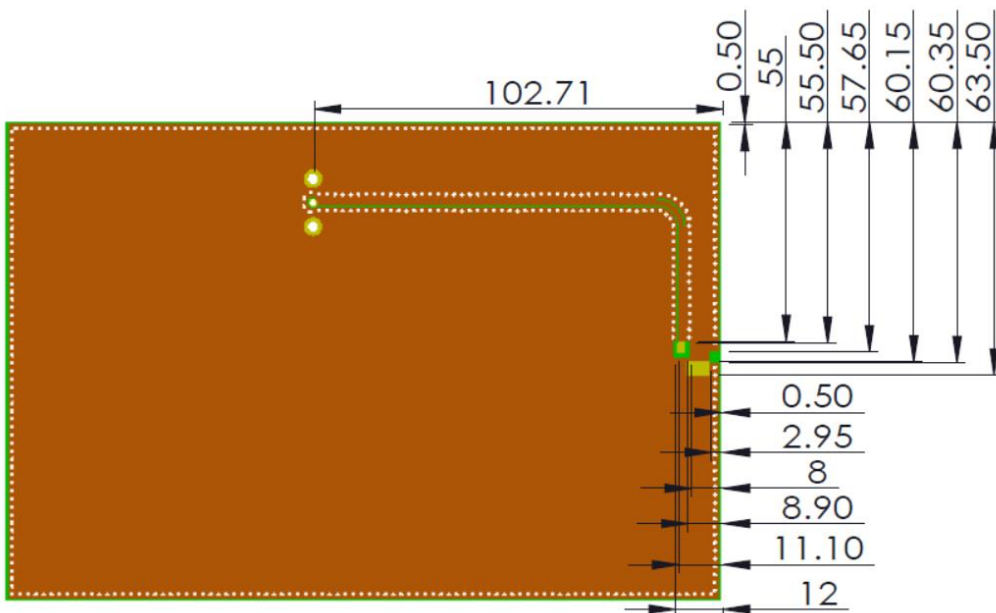

Issue: 1812

In the effort to improve our products, we reserve the right to make changes judged to be necessary.

CONFIDENTIAL AND PROPRIETARY INFORMATION

This document contains confidential and proprietary information of Pulse Electronics, Inc. (Pulse) and is protected by copyright, trade secret and other state and federal laws. Its receipt or possession does not convey any rights to reproduce, disclose its contents, or to manufacture, use or sell anything it may describe. Reproduction, disclosure or use without specific written authorization of Pulse is strictly forbidden.

Description: 2.4/5GHz Dualband WiFi SMT Antenna

Series: Embedded Antenna

**PART NUMBER: W3715**

**OTHER SPECIFICATIONS**

3, Clearance area (Bottom)

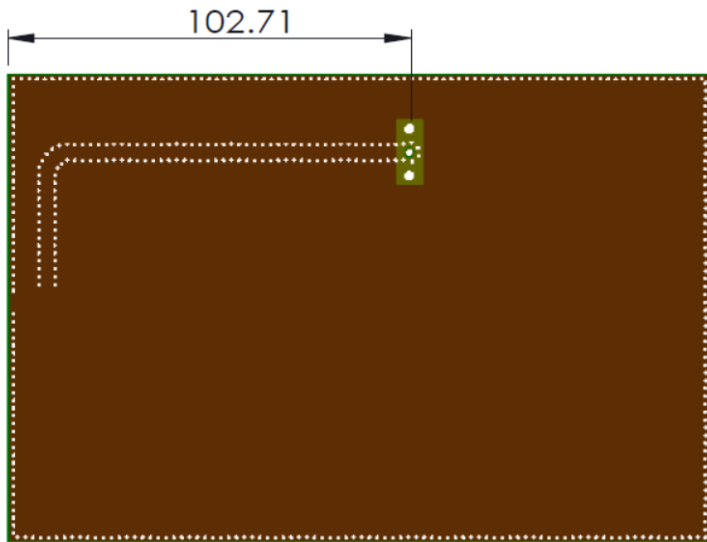

4, PCB Features

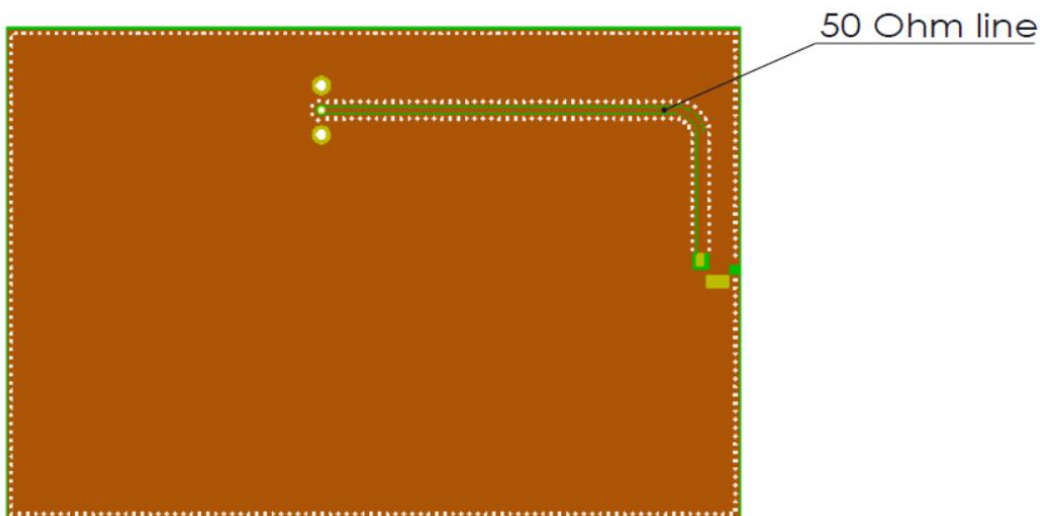

Issue: 1812

In the effort to improve our products, we reserve the right to make changes judged to be necessary.

CONFIDENTIAL AND PROPRIETARY INFORMATION

This document contains confidential and proprietary information of Pulse Electronics, Inc. (Pulse) and is protected by copyright, trade secret and other state and federal laws. Its receipt or possession does not convey any rights to reproduce, disclose its contents, or to manufacture, use or sell anything it may describe. Reproduction, disclosure or use without specific written authorization of Pulse is strictly forbidden.

Description: 2.4/5GHz Dualband WiFi SMT  
Antenna

Series: Embedded Antenna

**PART NUMBER: W3715**

**OTHER SPECIFICATIONS**

3, Antenna on test PCB

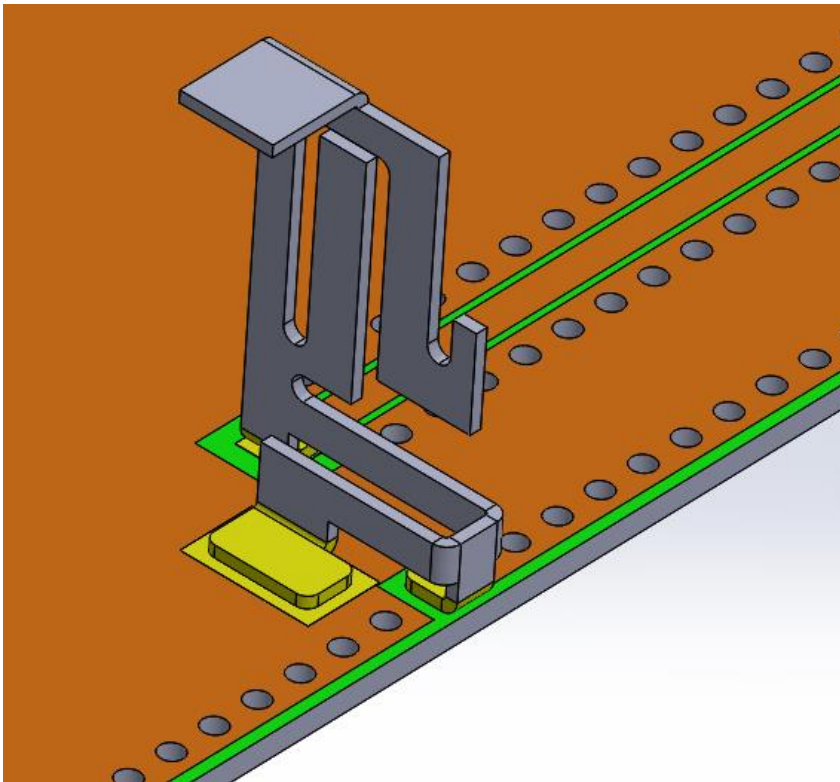

Issue: 1812

In the effort to improve our products, we reserve the right to make changes judged to be necessary.

CONFIDENTIAL AND PROPRIETARY INFORMATION

This document contains confidential and proprietary information of Pulse Electronics, Inc. (Pulse) and is protected by copyright, trade secret and other state and federal laws. Its receipt or possession does not convey any rights to reproduce, disclose its contents, or to manufacture, use or sell anything it may describe. Reproduction, disclosure or use without specific written authorization of Pulse is strictly forbidden.

Description: 2.4/5GHz Dualband WiFi SMT Antenna

Series: Embedded Antenna

**PART NUMBER: W3715**

**OTHER SPECIFICATIONS**

**Recommendation for reflow soldering process**

Printing stencil thickness 0,15 - 0,25 mm is recommended for the solder paste. The maximum soldering temperature should not exceed 260°C. The temperature profile recommendations for reflow soldering process is presented in the Figures 1 and 2. The reflow profile

presented in figure 1 describes minimum reflow temperatures. The reflow profile presented in figure 2 describes maximum reflow temperatures. located at the center of the coverage area.

	Method of heat transfer	Controlled hot air convection
1	Average temperature gradient in preheating	2.5 °C/s
2	Soak time	2-3 minutes
3	Max temperature gradient in reflow	3 °C/s
4	Time above 217 °C	Max 30 sec
5	Peak temperature in reflow	230 °C for 10 seconds
6	Temperature gradient in cooling	Max -5 °C/s

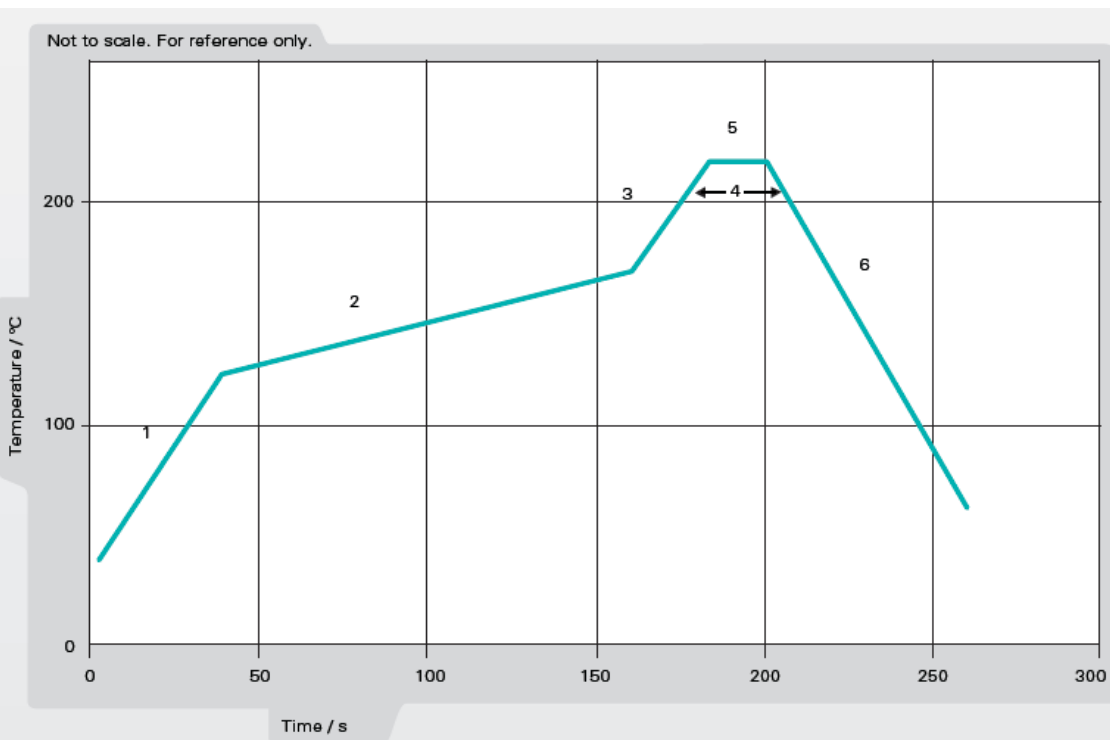

Figure 1. Minimum temperature profile recommendation for reflow soldering process

Issue: 1812

In the effort to improve our products, we reserve the right to make changes judged to be necessary.

CONFIDENTIAL AND PROPRIETARY INFORMATION

This document contains confidential and proprietary information of Pulse Electronics, Inc. (Pulse) and is protected by copyright, trade secret and other state and federal laws. Its receipt or possession does not convey any rights to reproduce, disclose its contents, or to manufacture, use or sell anything it may describe. Reproduction, disclosure or use without specific written authorization of Pulse is strictly forbidden.



Description: 2.4/5GHz Dualband WiFi SMT Antenna

Series: Embedded Antenna

PART NUMBER: W3715

OTHER SPECIFICATIONS

	Method of heat transfer	Controlled hot air convection
1	Average temperature gradient in preheating	2.5 °C/s
2	Soak time	2-3 minutes
3	Max temperature gradient in reflow	3 °C/s
4	Time above 217 °C	Max 60 sec
5	Time above 230 °C	Max 50 sec
6	Time above 250 °C	Max 10 sec
7	Peak temperature in reflow	260 °C for 5 seconds
8	Temperature gradient in cooling	Max -5 °C/s

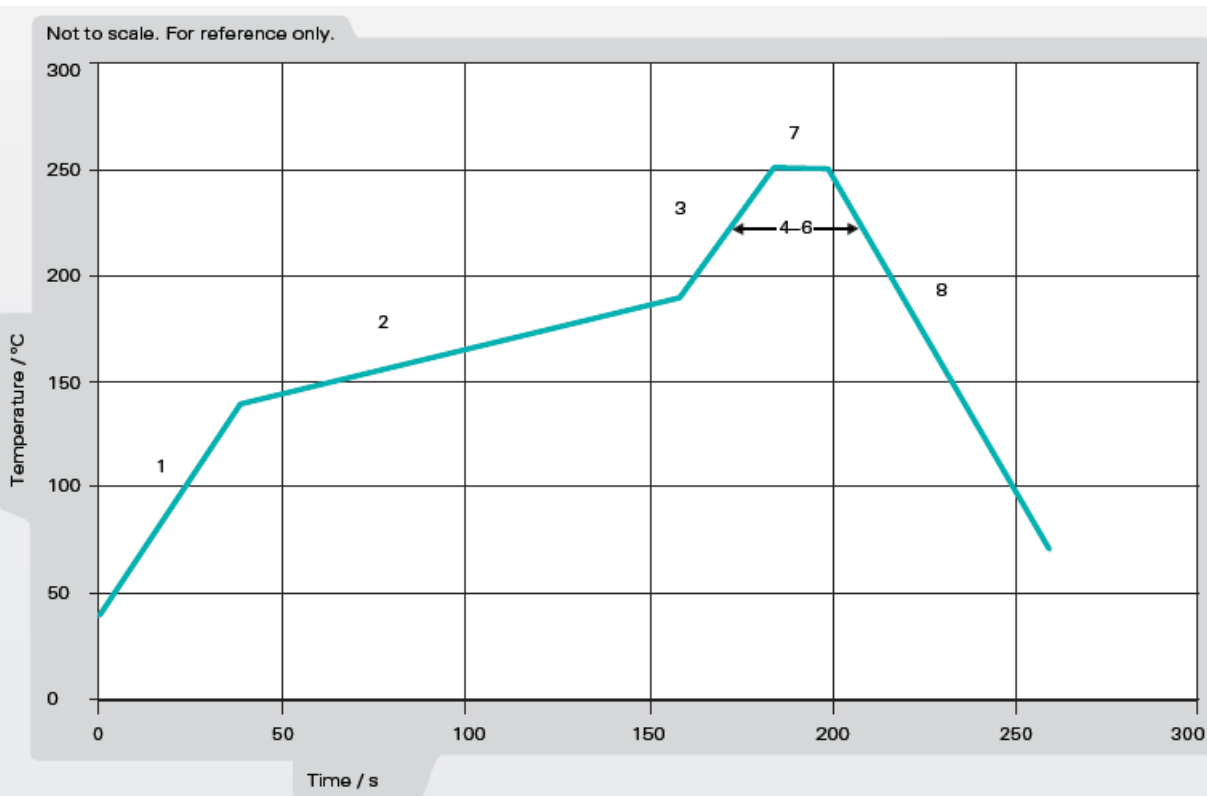

Figure 2. Maximum temperature profile recommendation for reflow soldering process

Issue: 1812

In the effort to improve our products, we reserve the right to make changes judged to be necessary.

CONFIDENTIAL AND PROPRIETARY INFORMATION

This document contains confidential and proprietary information of Pulse Electronics, Inc. (Pulse) and is protected by copyright, trade secret and other state and federal laws. Its receipt or possession does not convey any rights to reproduce, disclose its contents, or to manufacture, use or sell anything it may describe. Reproduction, disclosure or use without specific written authorization of Pulse is strictly forbidden.

Description: 2.4/5GHz Dualband WiFi SMT Antenna

Series: Embedded Antenna

**PART NUMBER: W3715**

CHARTS

VSWR

VSWR

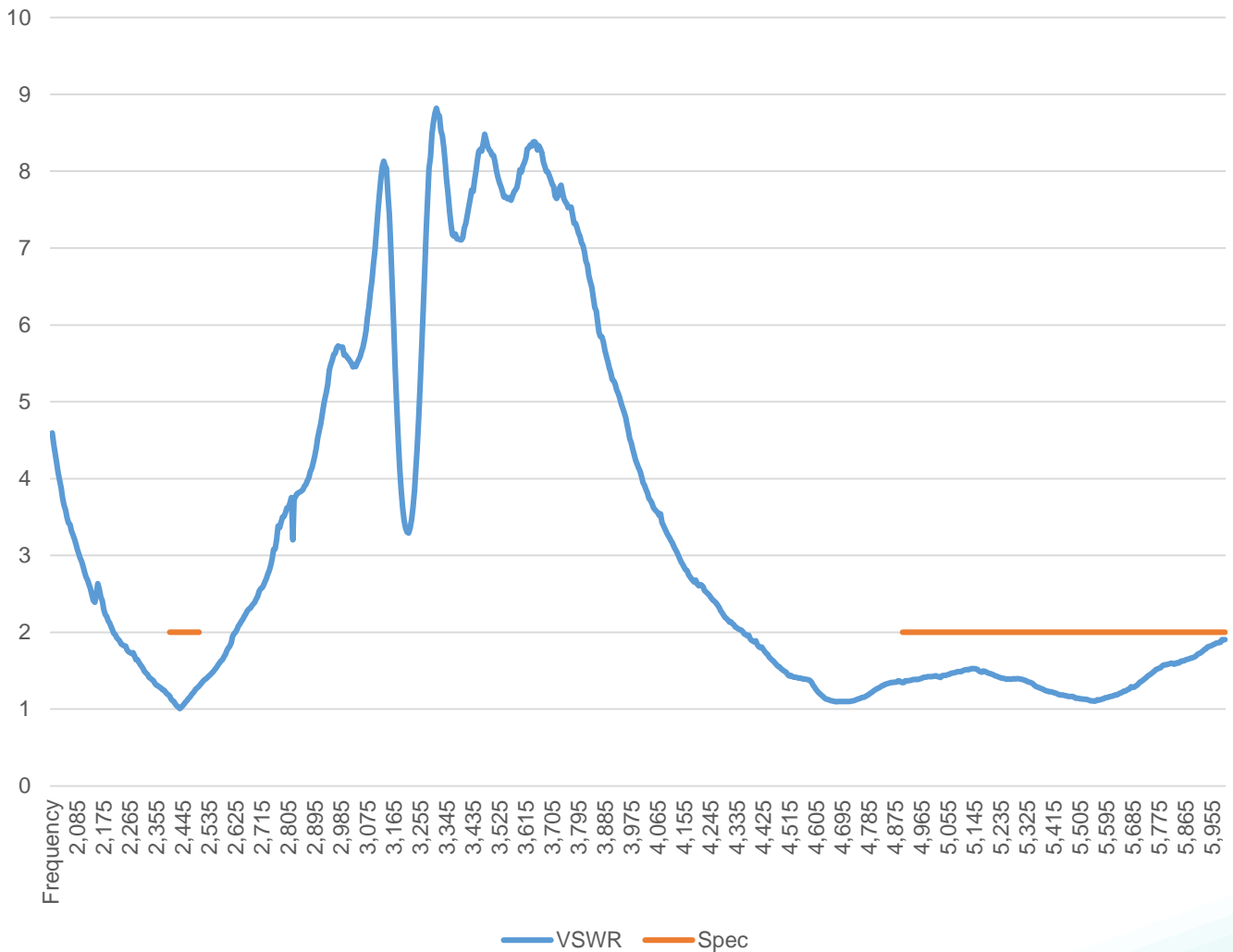

Issue: 1812

In the effort to improve our products, we reserve the right to make changes judged to be necessary.

CONFIDENTIAL AND PROPRIETARY INFORMATION

This document contains confidential and proprietary information of Pulse Electronics, Inc. (Pulse) and is protected by copyright, trade secret and other state and federal laws. Its receipt or possession does not convey any rights to reproduce, disclose its contents, or to manufacture, use or sell anything it may describe. Reproduction, disclosure or use without specific written authorization of Pulse is strictly forbidden.

Description: 2.4/5GHz Dualband WiFi SMT Antenna

Series: Embedded Antenna

**PART NUMBER: W3715**

**CHARTS**

Efficiency(%)

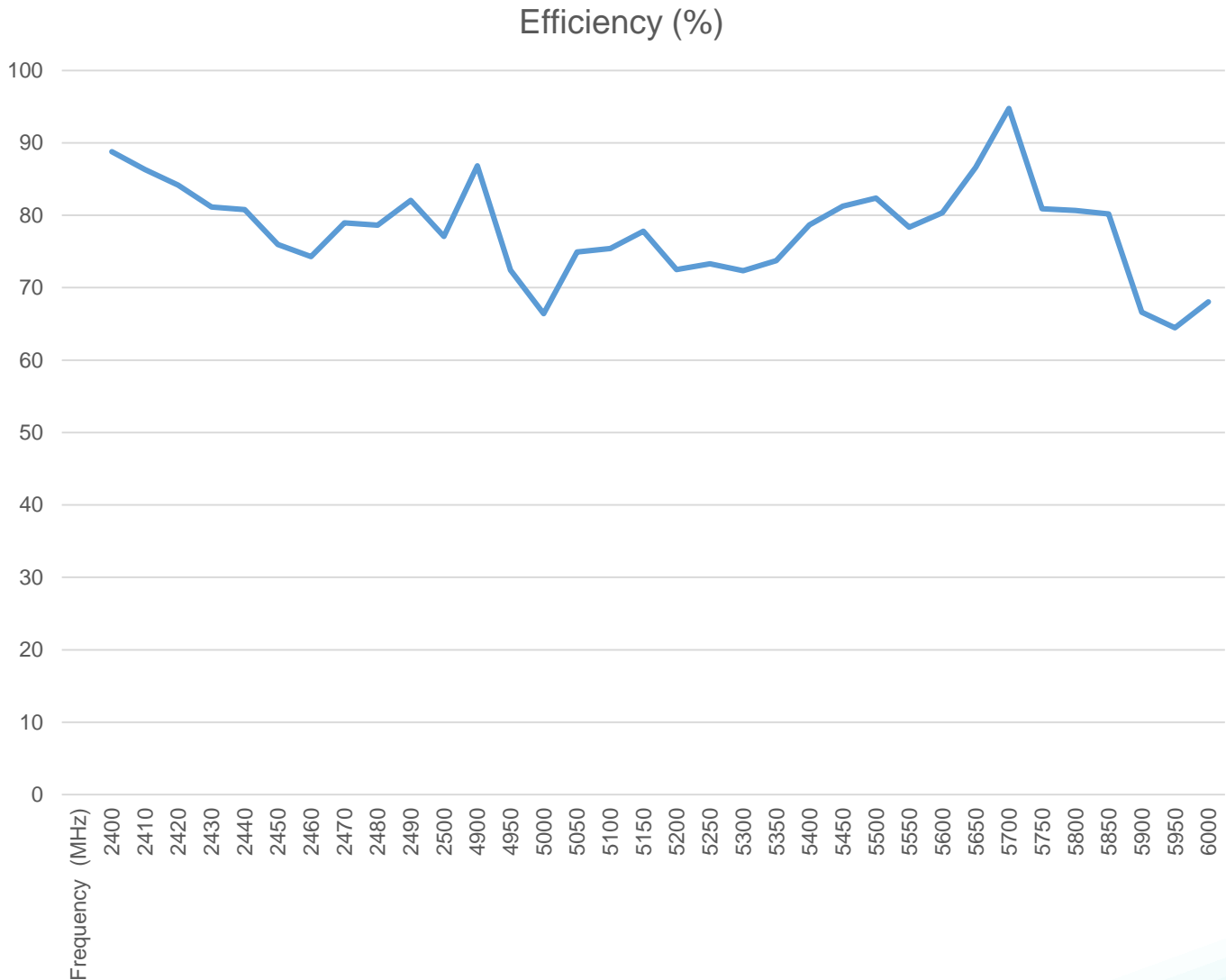

Issue: 1812

In the effort to improve our products, we reserve the right to make changes judged to be necessary.

CONFIDENTIAL AND PROPRIETARY INFORMATION

This document contains confidential and proprietary information of Pulse Electronics, Inc. (Pulse) and is protected by copyright, trade secret and other state and federal laws. Its receipt or possession does not convey any rights to reproduce, disclose its contents, or to manufacture, use or sell anything it may describe. Reproduction, disclosure or use without specific written authorization of Pulse is strictly forbidden.



Description: 2.4/5GHz Dualband WiFi SMT Antenna

Series: Embedded Antenna

**PART NUMBER: W3715**

**CHARTS**

**Peak Gain (dBi)**

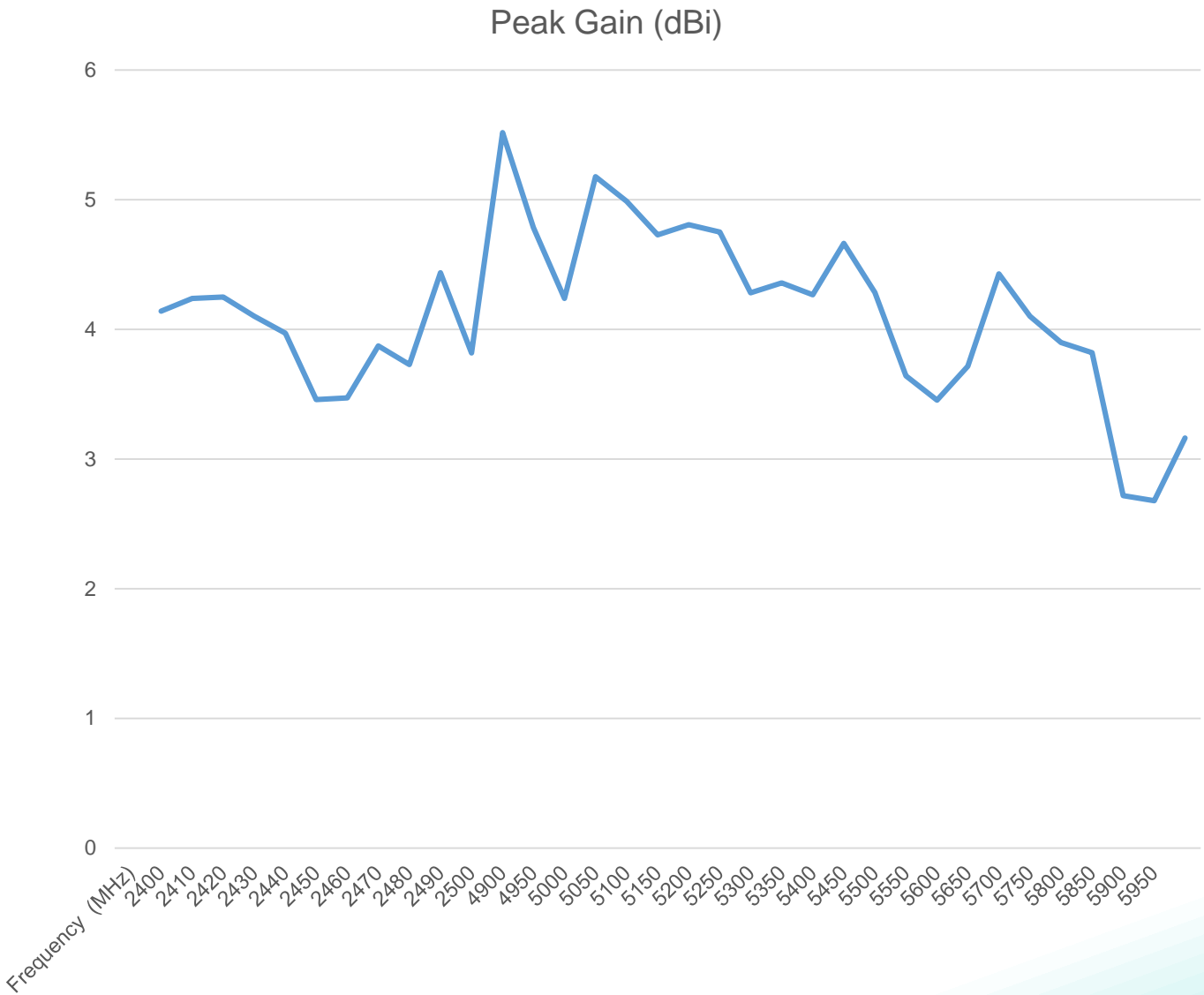

Issue: 1812

In the effort to improve our products, we reserve the right to make changes judged to be necessary.

CONFIDENTIAL AND PROPRIETARY INFORMATION

This document contains confidential and proprietary information of Pulse Electronics, Inc. (Pulse) and is protected by copyright, trade secret and other state and federal laws. Its receipt or possession does not convey any rights to reproduce, disclose its contents, or to manufacture, use or sell anything it may describe. Reproduction, disclosure or use without specific written authorization of Pulse is strictly forbidden.



Description: 2.4/5GHz Dualband WiFi SMT Antenna

Series: Embedded Antenna

PART NUMBER: W3715

CHARTS

Free Space Radiation Pattern

Elevation Plane

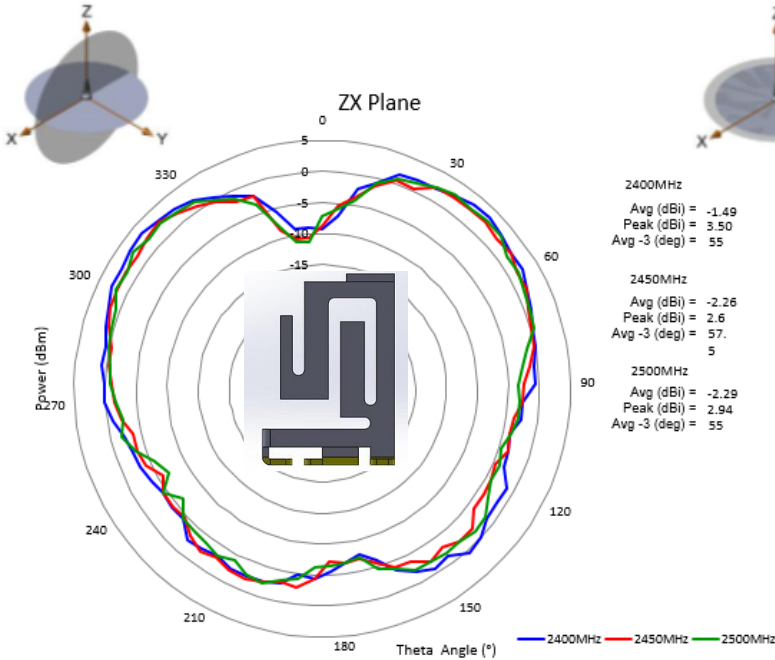

Horizontal Plane

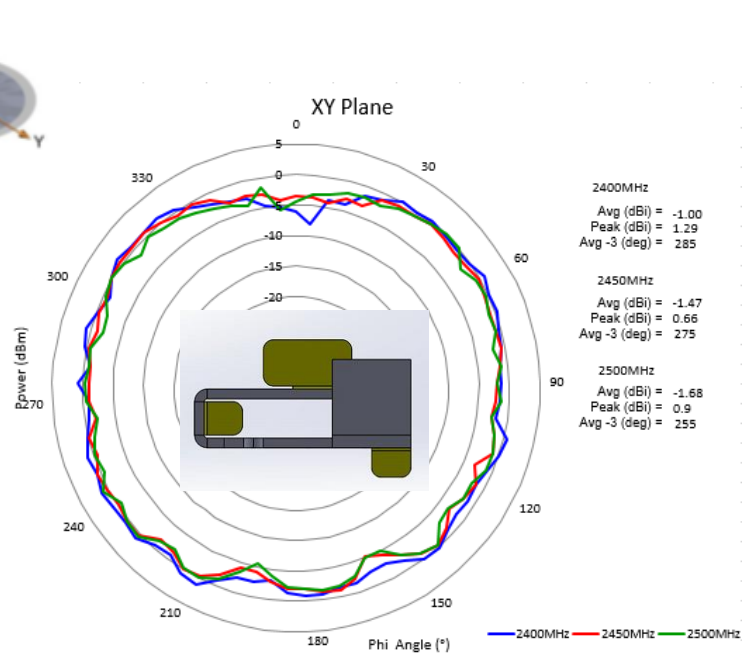

Issue: 1812

In the effort to improve our products, we reserve the right to make changes judged to be necessary.

CONFIDENTIAL AND PROPRIETARY INFORMATION

This document contains confidential and proprietary information of Pulse Electronics, Inc. (Pulse) and is protected by copyright, trade secret and other state and federal laws. Its receipt or possession does not convey any rights to reproduce, disclose its contents, or to manufacture, use or sell anything it may describe. Reproduction, disclosure or use without specific written authorization of Pulse is strictly forbidden.

Description: 2.4/5GHz Dualband WiFi SMT Antenna

Series: Embedded Antenna

PART NUMBER: W3715

CHARTS

Free Space Radiation Pattern

Elevation Plane

Horizontal Plane

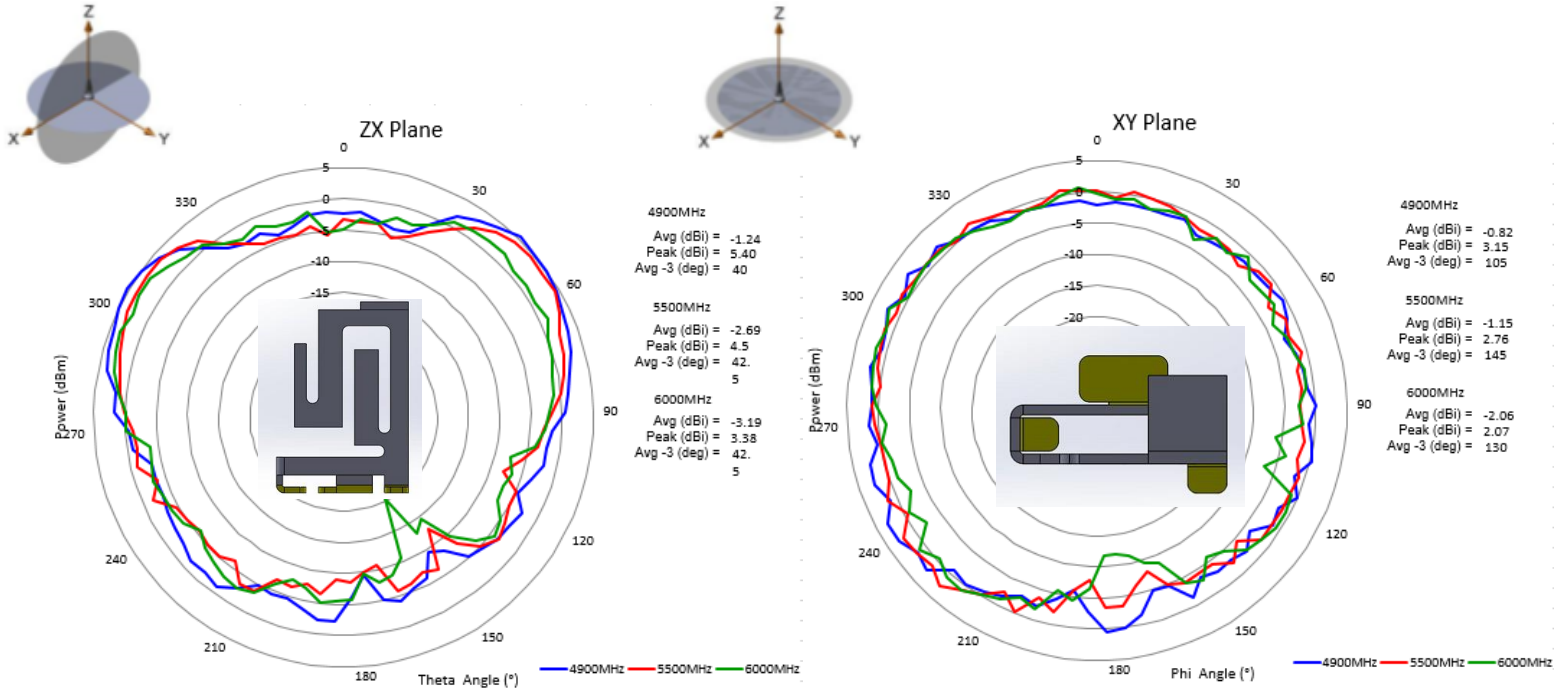

Issue: 1812

In the effort to improve our products, we reserve the right to make changes judged to be necessary.

CONFIDENTIAL AND PROPRIETARY INFORMATION

This document contains confidential and proprietary information of Pulse Electronics, Inc. (Pulse) and is protected by copyright, trade secret and other state and federal laws. Its receipt or possession does not convey any rights to reproduce, disclose its contents, or to manufacture, use or sell anything it may describe. Reproduction, disclosure or use without specific written authorization of Pulse is strictly forbidden.

Description: 2.4/5GHz Dualband WiFi SMT Antenna

Series: Embedded Antenna

**PART NUMBER: W3715**

## PACKAGING

Tape and Reel packing:  
200 PCS/ Tape and Reel  
400PCS/ Carton box

Tape Width : 32mm  
Tape Material : Polystyrene



Issue: 1812

In the effort to improve our products, we reserve the right to make changes judged to be necessary.

CONFIDENTIAL AND PROPRIETARY INFORMATION

This document contains confidential and proprietary information of Pulse Electronics, Inc. (Pulse) and is protected by copyright, trade secret and other state and federal laws. Its receipt or possession does not convey any rights to reproduce, disclose its contents, or to manufacture, use or sell anything it may describe. Reproduction, disclosure or use without specific written authorization of Pulse is strictly forbidden.