

## Description

AP9060 is designed to protect the latest generation of PMICs for portable applications such as Smartphones, UMPCs and others that utilize battery power.

The device, with its integrated low resistance p-channel MOSFET, operates as a switch and passes the input voltage through to the output till the input reaches a clamp voltage limit. Once  $V_{IN}$  goes above the clamp limit, which is set to 11.15V, the output voltage gets clamped and the feedback loop maintains the clamped  $V_{OUT}$  by reducing the drive to the p-channel FET.

The output voltage is clamped at 11.15V to ensure that a following PMIC can detect a faulty charger and ensure safe and proper communication to the system.

AP9060 also supports reverse operation whereby it can pass up to 1A of current from the PMIC to the load connected to the USB port. This makes AP9060 suitable for USB On-The-Go enabled devices.

The AP9060 protection device is available in a low-profile W-DFN1114-3 package with a typical height of 0.8mm.

## Applications

- Power Interface for New Generation PMICs
- Charger Front-End Protection
- Smartphones
- UMPC
- Portable Applications

## Pin Assignments

**W-DFN1114-3**

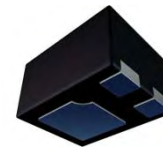
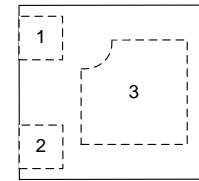

## Features

- Wide Input Voltage Range of 3V – 30V
- Ultra-Low Bias Current
- Integrated Low On-Resistance P-Channel FET
- Output Voltage Clamped at 11.15V
- PMOS Protection Mechanism – Removes EMI Issues Typically Associated with an NMOS Solution
- Supports Reverse Current Operation (USB OTG)
- Available in a W-DFN1114-3 Package
- **Totally Lead-Free & Fully RoHS Compliant (Notes 1 & 2)**
- **Halogen and Antimony Free. “Green” Device (Note 3)**

- Notes:
1. No purposely added lead. Fully EU Directive 2002/95/EC (RoHS) & 2011/65/EU (RoHS 2) compliant.
  2. See <http://www.diodes.com> for more information about Diodes Incorporated's definitions of Halogen- and Antimony-free, "Green" and Lead-free.
  3. Halogen- and Antimony-free "Green" products are defined as those which contain <900ppm bromine, <900ppm chlorine (<1500ppm total Br + Cl) and <1000ppm antimony compounds.

## Typical Applications Circuit

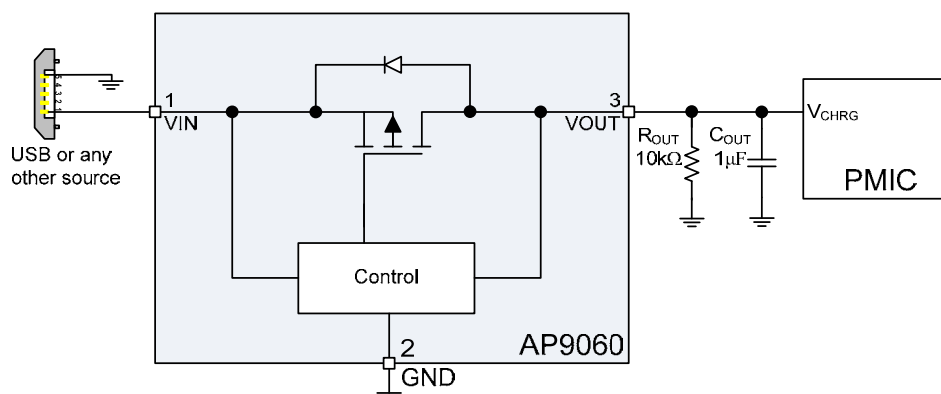

**Figure 1 Typical Application Circuit**

## Pin Descriptions

Pin Number	Pin Name	Function
1	VIN	Input voltage to the device.
2	GND	System ground.
3/PAD	VOUT	Output voltage, which follows V <sub>IN</sub> and gets clamped if V <sub>IN</sub> exceeds the clamp voltage of 11.15V (typ).

## Functional Block Diagram

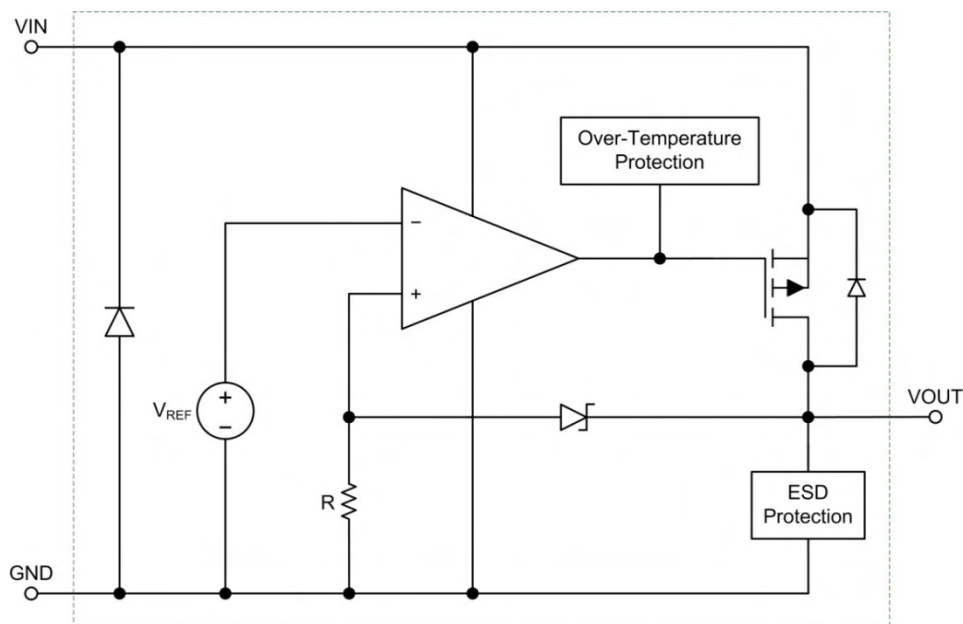

Figure 2 Functional Block Diagram

## Absolute Maximum Ratings (Note 4) (@T<sub>A</sub> = +25°C, unless otherwise specified.)

Symbol	Parameter	Rating	Unit
V <sub>IN</sub>	Input Supply Voltage	-0.3 to +30	V
I <sub>MAX</sub>	Maximum Continuous Switch Current (Note 6)	2.6	A
	T <sub>A</sub> = +25°C	1.6	
P <sub>D</sub>	Power Dissipation @ T <sub>A</sub> = +25°C (Note 6)	1.1	W
T <sub>J</sub>	Junction Temperature Range	-40 to +125	°C
T <sub>STG</sub>	Storage Temperature Range	-55 to +150	°C
T <sub>L</sub>	Maximum Lead Temperature for Soldering Purposes	260	°C
<b>ESD Susceptibility (Note 5)</b>			
HBM	Human Body Model	8.0	kV
MM	Machine Model	350	V

- Notes:
- Stresses greater than the 'Absolute Maximum Ratings' specified above may cause permanent damage to the device. These are stress ratings only; functional operation of the device at these or any other conditions exceeding those indicated in this specification is not implied. Device reliability may be affected by exposure to absolute maximum rating conditions for extended periods of time.
  - Semiconductor devices are ESD sensitive and may be damaged by exposure to ESD events. Suitable ESD precautions should be taken when handling and transporting these devices.

### Thermal Resistance (Note 6)

Symbol	Parameter	Rating	Unit
$\theta_{JA}$	Junction to Ambient	85	°C/W

Note: 6. Surface mounted on JEDEC's High Effective Thermal Conductivity Test Board (JESD51-7).

### Recommended Operating Conditions (Note 7) (@ $T_A = +25^\circ\text{C}$ , unless otherwise specified.)

Symbol	Parameter	Min	Max	Unit
$V_{IN}$	Supply Voltage	3	30	V
$T_A$	Operating Ambient Temperature Range	-40	+85	°C

Note: 7. The device function is not guaranteed outside of the recommended operating conditions.

### Electrical Characteristics (@ $T_A = +25^\circ\text{C}$ , unless otherwise specified.)

AP9060 is tested at  $V_{IN} = 5\text{V}$ ,  $I_{OUT} = 0\text{mA}$ , unless otherwise noted.

Symbol	Parameter	Test Conditions	Min	Typ	Max	Unit
$V_{CLAMP}$	Output clamp voltage	$V_{IN} = 30\text{V}$	10.8	11.15	11.5	V
$R_{ON}$	On-Resistance (Note 8)	$V_{IN} = 5\text{V}$ , $I_{OUT} = 1000\text{mA}$ $V_{IN} = 3\text{V}$ , $I_{OUT} = 1000\text{mA}$		90 105	120 139	m $\Omega$
$V_{pk}$	Peak Output Voltage (Note 9)	$V_{IN}$ goes from 0V to 30V with 100ns rise time, $C_{OUT} = 100\text{nF}$			16.0	V
$I_{bias}$	Input Bias Current	$V_{IN} = 5\text{V}$ $V_{IN} = 30\text{V}$		5 25	6 31	$\mu\text{A}$
$THM_{SD}$	Thermal Shutdown Threshold (Note 9)	$R_{OUT} = 10\text{k}\Omega$		140		°C
$THM_{hyst}$	Thermal Shutdown Hysteresis (Note 9)	$R_{OUT} = 10\text{k}\Omega$		20		°C
$V_{OUT\_REV}$	Reverse Supply Voltage on VOUT (Note 10)	$I_{IN} = -500\text{mA}$	3.0	5.0	8.0	V
$I_{IN\_REV}$	Reverse Load Current on VIN (Note 10)	$V_{OUT} = 5\text{V}$		-500	-1000	mA
$T_{start}$	Soft-Start Time	$V_{IN} = 5\text{V}$		10		ms

Notes: 8. Pulse tested with a width of 20ms.

9. Guaranteed by design.

10. To support reverse power operation, as in the case of USB OTG systems. A voltage source is connected to  $V_{OUT}$  and a load connected on  $V_{IN}$ .

**Typical Performance Characteristics**

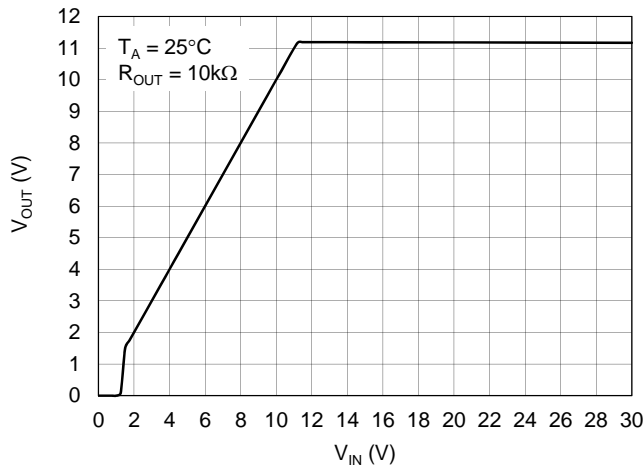

Figure 3  $V_{OUT}$  vs.  $V_{IN}$

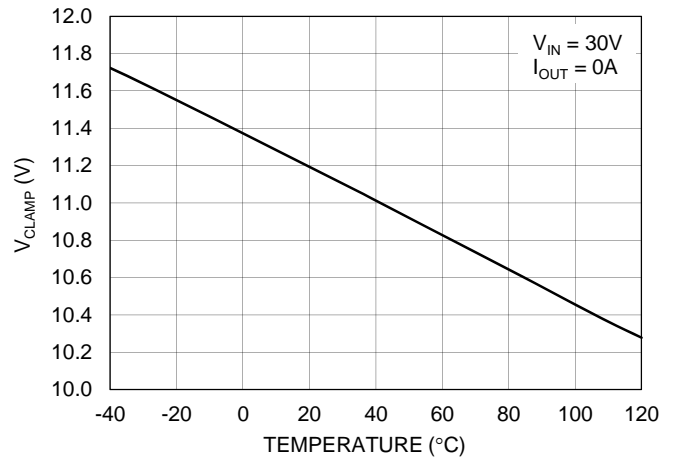

Figure 4 Output Clamp Voltage vs. Temperature

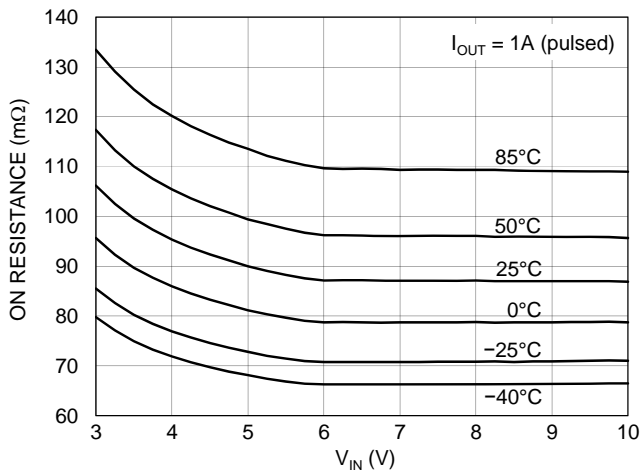

Figure 5 On-Resistance vs.  $V_{IN}$  and Temperature

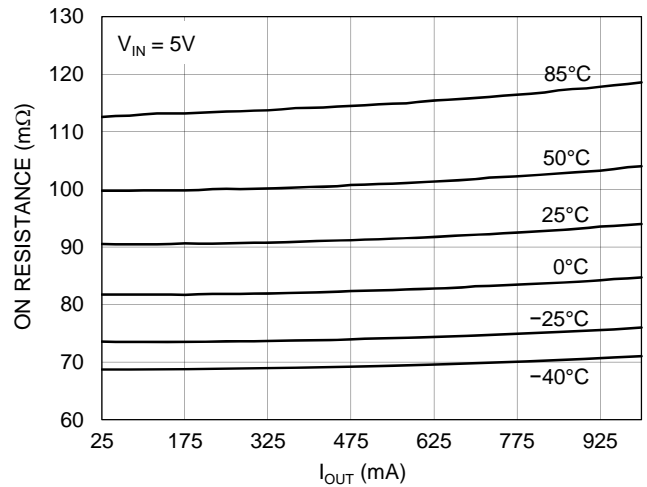

Figure 6 On-Resistance vs.  $I_{OUT}$  and Temperature

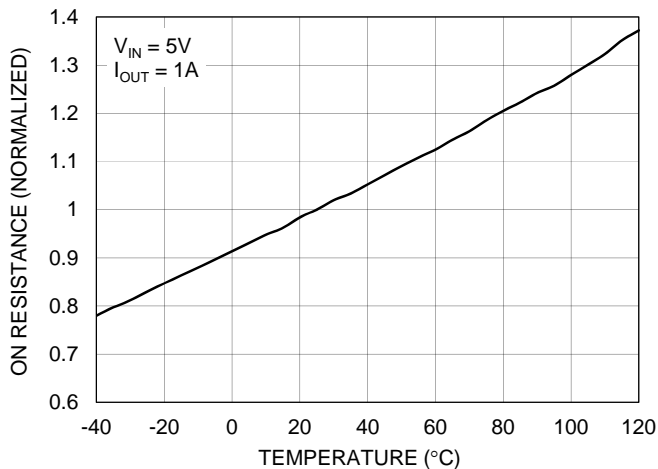

Figure 7 On-Resistance (normalized) vs. Temperature

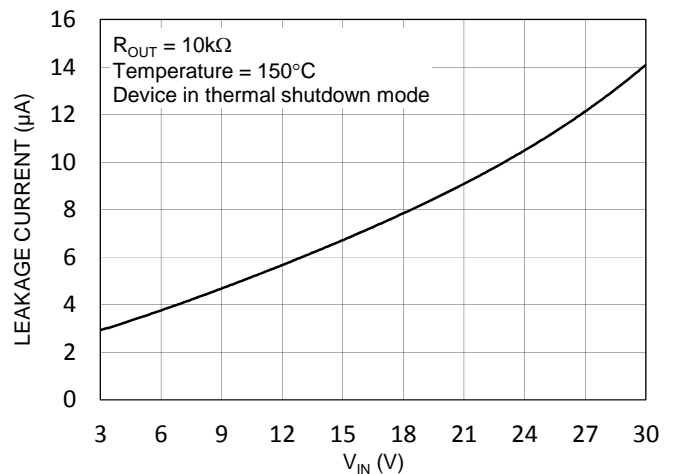

Figure 8 FET Leakage Current (in thermal shutdown) vs.  $V_{IN}$

---

## Application Information

---

### Over-Voltage Protection

AP9060 protects sensitive circuits by clamping the input voltage to a safe level. In other words, AP9060 conditions the input voltage before presenting it to the sensitive circuitry.

The clamp voltage on AP9060 is set to 11.15V (typically at room temperature). Therefore, the sensitive circuitry will not be exposed to a voltage greater than 11.15V. As a consequence, it is important to ensure that the sensitive ICs that follow AP9060 are safe to operate up to the clamp voltage level (refer to Figure 4 for variation in clamp voltage over temperature).

If the input voltage is below  $V_{CLAMP}$ , the PMOS pass transistor in the AP9060 fully turns on and only  $I \times R_{ON}$  is dropped across the FET (where,  $I$  is the current drawn by the sensitive ICs). On the other hand, if  $V_{IN}$  is greater than the clamp voltage, then AP9060 limits the drive to the FET to ensure that the voltage on  $V_{OUT}$  is maintained at the clamp level.

### Over-Temperature Protection

As a secondary protection mechanism, AP9060 incorporates an over-temperature shutdown feature. Therefore, if the sensitive circuitry draws too much current either in normal mode or in the clamp mode, AP9060 will turn off the PMOS transistor, provided the junction temperature exceeds the thermal shutdown threshold ( $THM_{SD}$ ). Thereafter, the device will resume normal operation once the junction temperature falls below  $THM_{SD} - THM_{hyst}$ .

In the clamp mode, given that any input voltage above  $V_{CLAMP}$  is dropped across the pass transistor in AP9060, care must be taken to keep the power dissipation within AP9060 in check by minimising the current drawn in this mode.

### Fast Input Transient Protection

AP9060 will also protect the sensitive circuits against fast input transients. Upon detecting a fast transient on  $V_{IN}$ , AP9060 reduces the drive to the FET in order to minimise the overshoot on  $V_{OUT}$ . With 100nF on  $V_{OUT}$ , if the voltage on  $V_{IN}$  goes from 0V to 30V in 100ns, the output voltage will not peak above  $V_{pk}$ .

### Reverse Operation

AP9060 supports the USB OTG specification and can operate in the reverse direction as well. Therefore, if the sensitive circuitry drives a voltage on  $V_{OUT}$  ( $V_{OUT\_REV}$ ) and a load is connected on  $V_{IN}$  ( $I_{IN\_REV}$ ), then AP9060 will turn the FET on in the reverse direction and only  $I \times R_{ON}$  will be dropped across the device, similar to the forward operation.

However, note that neither over-voltage nor over-temperature protection mechanisms will function in this mode.

### Output Capacitor

It is recommended to have a capacitor on  $V_{OUT}$  in a range between 100nF and 10 $\mu$ F.

### Output Resistor

It is recommended to have a resistor on  $V_{OUT}$  in a range between 10k $\Omega$  and 100k $\Omega$ .

**Ordering Information**

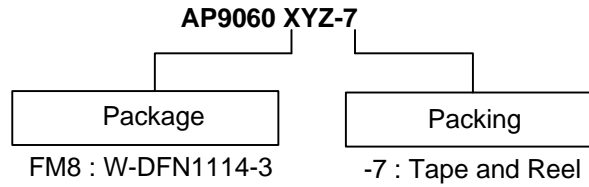

Part Number	Package Code	Packaging (Note 11)	7" Tape and Reel	
			Quantity	Part Number Suffix
AP9060FM8-7	FM8	W-DFN1114-3	3000/Tape & Reel	-7

Note: 11. Pad layout as shown on Diodes Inc. suggested pad layout document AP02001, which can be found on our website at <http://www.diodes.com/datasheets/ap02001.pdf>.

**Marking Information**

W-DFN1114-3

( Top View )

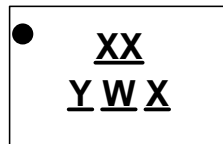

XXX : Identification code  
Y : Year 0~9  
W : Week : A~Z : 1~26 week;  
           a~z : 27~52 week; z represents  
           52 and 53 week  
X : A~Z : Internal Code

Device	Package	Identification Code
AP9060FM8-7	W-DFN1114-3	CZ

**Package Outline Dimensions** (All dimensions in mm.)

W-DFN1114-3

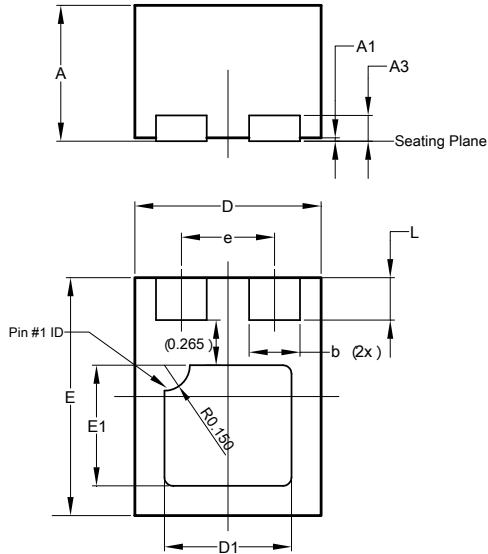

W-DFN1114-3			
Dim	Min	Max	Typ
A	0.77	0.83	0.80
A1	0	0.05	0.02
A3	-	-	0.152
b	0.25	0.35	0.30
D	1.05	1.15	1.10
D1	0.70	0.80	0.75
e	-	-	0.55
E	1.35	1.45	1.40
E1	0.66	0.76	0.71
L	0.20	0.30	0.25
All Dimensions in mm			

**Suggested Pad Layout**

W-DFN1114-3

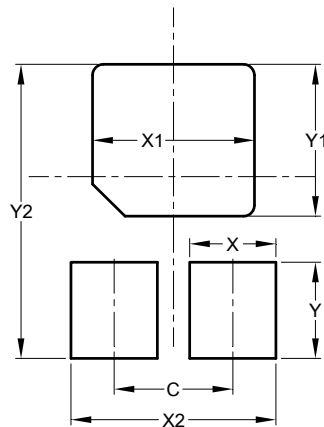

Dimensions	Value (in mm)
C	0.55
X	0.400
X1	0.750
X2	0.950
Y	0.450
Y1	0.710
Y2	1.375

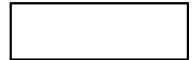

**Tape Orientation** (All Dimensions in mm.) (Note 12)

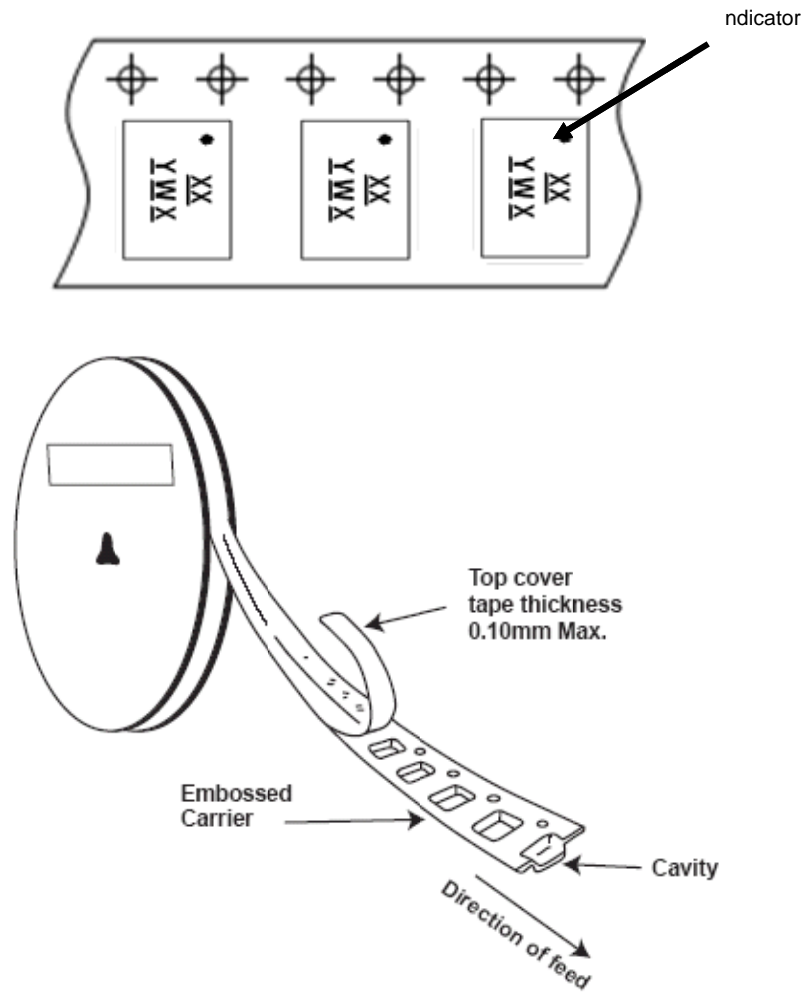

Note: 12. The taping orientation of the other package type can be found on our website at <http://www.diodes.com/datasheets/ap02007.pdf>



**IMPORTANT NOTICE**

DIODES INCORPORATED MAKES NO WARRANTY OF ANY KIND, EXPRESS OR IMPLIED, WITH REGARDS TO THIS DOCUMENT, INCLUDING, BUT NOT LIMITED TO, THE IMPLIED WARRANTIES OF MERCHANTABILITY AND FITNESS FOR A PARTICULAR PURPOSE (AND THEIR EQUIVALENTS UNDER THE LAWS OF ANY JURISDICTION).

Diodes Incorporated and its subsidiaries reserve the right to make modifications, enhancements, improvements, corrections or other changes without further notice to this document and any product described herein. Diodes Incorporated does not assume any liability arising out of the application or use of this document or any product described herein; neither does Diodes Incorporated convey any license under its patent or trademark rights, nor the rights of others. Any Customer or user of this document or products described herein in such applications shall assume all risks of such use and will agree to hold Diodes Incorporated and all the companies whose products are represented on Diodes Incorporated website, harmless against all damages.

Diodes Incorporated does not warrant or accept any liability whatsoever in respect of any products purchased through unauthorized sales channel. Should Customers purchase or use Diodes Incorporated products for any unintended or unauthorized application, Customers shall indemnify and hold Diodes Incorporated and its representatives harmless against all claims, damages, expenses, and attorney fees arising out of, directly or indirectly, any claim of personal injury or death associated with such unintended or unauthorized application.

Products described herein may be covered by one or more United States, international or foreign patents pending. Product names and markings noted herein may also be covered by one or more United States, international or foreign trademarks.

**LIFE SUPPORT**

Diodes Incorporated products are specifically not authorized for use as critical components in life support devices or systems without the express written approval of the Chief Executive Officer of Diodes Incorporated. As used herein:

A. Life support devices or systems are devices or systems which:

1. are intended to implant into the body, or
2. support or sustain life and whose failure to perform when properly used in accordance with instructions for use provided in the labeling can be reasonably expected to result in significant injury to the user.

B. A critical component is any component in a life support device or system whose failure to perform can be reasonably expected to cause the failure of the life support device or to affect its safety or effectiveness.

Customers represent that they have all necessary expertise in the safety and regulatory ramifications of their life support devices or systems, and acknowledge and agree that they are solely responsible for all legal, regulatory and safety-related requirements concerning their products and any use of Diodes Incorporated products in such safety-critical, life support devices or systems, notwithstanding any devices- or systems-related information or support that may be provided by Diodes Incorporated. Further, Customers must fully indemnify Diodes Incorporated and its representatives against any damages arising out of the use of Diodes Incorporated products in such safety-critical, life support devices or systems.

Copyright © 2012, Diodes Incorporated

[www.diodes.com](http://www.diodes.com)