

CUSTOMER'S NAME

MOUSER ELECTRONICS

ALPHA REFERENCE NO.

SP15050140

SPECIFICATION

PART NO.	ALPHA MODEL NAME
	RA00B1MF-10-08T1-JISB10K-016

MODEL NAME

MODEL NO.

APPROVAL

PREPARED BY	REVIEWED BY	APPROVED BY
 鄧彩霞 2015.5.15		 李延玲 2015-5-15



ALPHA

台灣艾華電子工業股份有限公司

桃園市中正路1221~1223號9樓

TAIWAN ALPHA ELECTRONIC CO., LTD

9F,NO.1221,Chung Cheng Rd., Taoyuan, Taiwan, R.O.C.

Tel: 886-3-3577799 Fax: 886-3-3577700

EMAIL: sales@taiwanalpha.com.tw

URL: <http://www.taiwanalpha.com>

文管中心
2010.09.13
發行章

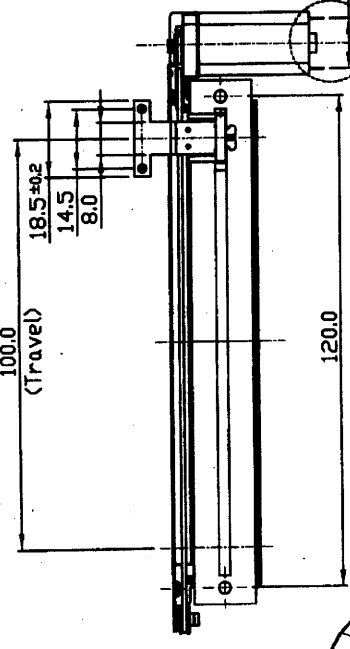
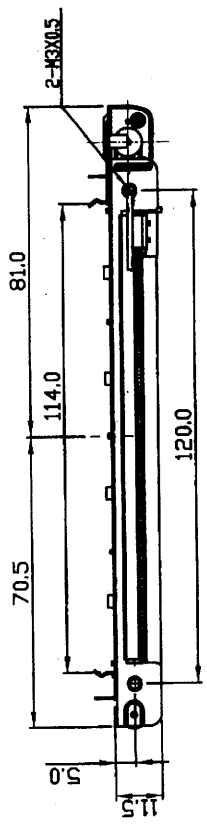

石碇福隆工業區文管中心
2010-09-20
收文日

P.C.B. MOUNTING HOLE DIMENSIONS

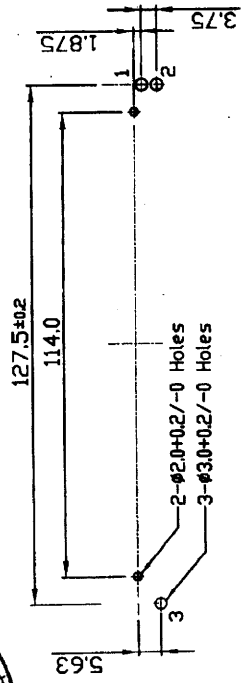

Circuit diagram

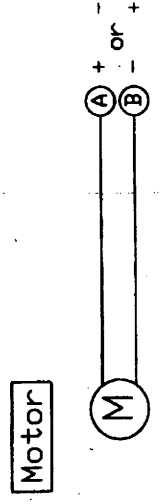
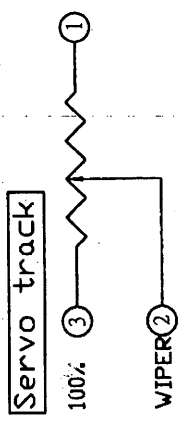

Moving direction of lever and contacts

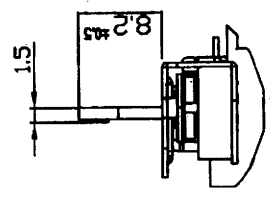
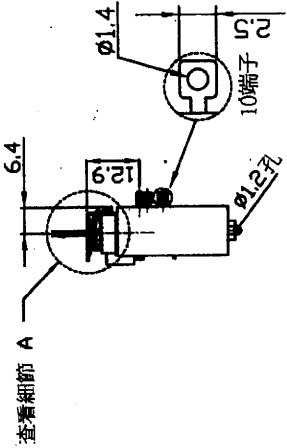
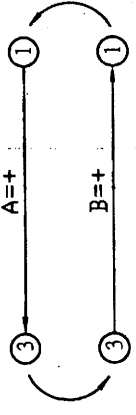

細節 A
刻度 2:1

NOTE:
1. In case of putting a knob on the lever, the length below 25mm is recommended.
2. Mounting screw thread length shall be chassis thickness +3mm or 2 to 2.5mm

No.	DATE	DESCRIPTION	PART No.	NAME	TOL. UNLESS OTHERWISE STATED	FINISH	SCALE	DRAWN BY	CHECKED BY	DRAWING No.
				RA00B1MF-10-08T1-XXX-012	less than ±0.3 above ±0.5 above ±1.0 above ±5	M P.P.H.	1:1	呂 99.9.7	劉 99.9.7	RA00B1MF

TAIWAN ALPHA ELECTRONIC CO., LTD.

一、Environment

1.1 Operating temperature range 使用溫度範圍 -10~+70°C

1.2 Test conditions

Standard atmospheric conditions

Unless otherwise specified, the standard range of atmospheric conditions for making measurements and tests is as follows:

Ambient temperature: 5~35°C Relative humidity : 45~85%

Air pressure: 860 mbar to 1060 mbar

If there is any doubt about the results, measurements shall be made within the following limit:

Ambient temperature: 20±2°C Relative humidity : 60~70%

Air pressure: 860 mbar to 1060 mbar

試驗條件

標準狀態

無特別規定之實驗及測定時以溫度 5~35°C，相對溼度 45~85%，氣

壓 860~1060mbar 之標準狀態測定

發生判定疑問或另有特別要求則以

基準狀態(溫度 20±2°C，相對溼度

60~70%氣壓 860~1060mbar)為準

測定

二、Mechanical characteristics 機械的性能

Item 項目	Conditions 條件		Specifications 規格
1 Lever travel 把柄移動距離			100 ± 1mm
2 Operating force 作動力	Traveling speed 移動速度 40mm/sec 秒	Standard atmospheric conditions 常溫 5°C TO 35°C	< 50gf
		Starting force (standard atmospheric conditions) 始動力(常溫)	Operating force+100gf max 作動力 100gf 以下
3 Braking force 把柄止動強度	5 kgf at a 5mm position from the mounting surface 5 kgf 以上 (固定面起 5mm 處測定)		Without excessive play or poor contact 無顯著鬆動, 接觸不良
4 Side thrust of the lever 把柄橫擠壓強度	A static load of 5kgf shall be applied for 10 sec at the 5mm position from the mounted plate in the direction perpendicular to the axial direction, with the potentiometer mounted in the assembly conditions 本體以螺絲固定於底板上，固定面起 5mm 位置，在於把柄移動方向垂直之方向加 5kgf 靜負荷 10 秒以上		Without deformation or damage in the sliding part and contact part 操作部位及關聯部品不可有顯著變形及破損
5 Thrust and tensile lever 把柄擠壓引張強度	Thrust and tensile static load of 5kgf shall be applied to the potentiometer in the lever direction for 10 sec 於把柄垂直之端面方向，擠壓或引張方向加 5kgf 靜荷重 10sec 以上		Without unusual sliding behavior and damage or play in the lever and unusual sliding. 柄不能有破損，滑動異常

	Item 項目	Conditions 條件	Specifications 規格
6	Lever wobble 把柄橫振	A torsion moment of 250 gf-cm shall be applied at the lever in a direction perpendicular to the axial direction and then the displacement shall be measured 於把柄頭端加 250 gf-cm 之力具，與把柄移動方向相對應之垂直方向作彎曲測定	$2 (2 \times L / 20)$ mm p - p or less L=length of lever L=把柄之長度
7	Distance form the center of the lever 把柄之偏心	After sliding lever as far as it will go in each direction, the distance from the center of the lever to the middle of the mounting screw hole shall be measure at the both ends 把柄對固定孔中心作單側測定	0.5mm or less on each end 單側 0.5mm 以下
8	Resistance to soldering heat 銲錫耐熱性	After soldering without excessive looseness of terminals and failure contact 銲錫後，端子不能有顯著的接觸不良發生	Change in total resistance is relative to the value before test: $\pm 5\%$ without excessive looseness of terminals and contact failure 全阻值初期值 $\pm 5\%$ 以內，端子不能有顯著的接觸不良發生
9	Side life test Without load 無負荷壽命測試	One complete cycle is having the lever travel from origin to full displacement (100mm) and back. In life test, the samples are subjected to a working speed of 600 cycles/hr for a total of 30,000 \pm 200 cycles. 壽命測試，移動速度 600 回/時(往復 1 次 1 回)，合計 30,000 \pm 200 次的滑動。	After Life Test – Total resistance: $\pm 15\%$ Noise: 150 mv Max. Residual resistance: 80 Ω Operating force: < 50gf 壽命測試後 全阻值變化: $\pm 15\%$ 雜音: 150 mv 最大 殘留阻值: 80 Ω 以下 滑動力: 50gf 以內
三、Electrical characteristics 電氣的性能			
1	Nominal total resistance 全阻抗值許容差		10K Ω $\pm 20\%$
2	Resistance law (Taper) 電阻變化特性	Measurement shall be made by the resistance law method 電壓法測定	Refer to Taper graph shown 參照 Taper 表

	Item 項目	Conditions 條件	Specifications 規格	
3	Power rating 額定功率	<p>Power rating is based on continuous full load operation at the maximum voltage between terminal 1 and 3. power rating vs. ambient temperature shall be as denoted on the following graph.</p> <p>端子 1 ~ 3 間連續負載後之功率最大功率周圍溫度對功率影響之曲線如下圖表</p>  <p>The graph plots Power rating ratio (Y-axis, 0 to 100) against Ambient temperature (X-axis, 0 to 100). A solid line shows the ratio is constant at 100% until 50°C, then drops linearly to 33% at 70°C. A dashed horizontal line is drawn at the 33% ratio level.</p>	0.5W	
4	Rated voltage 額定電壓	<p>Rated voltage (額定電壓) $E = \sqrt{PR}$ P : rating power (額定功率) E : Rated voltage (額定電壓) R : nominal total resistance(全阻抗值)</p> <p>when the rated voltage exceeds the maximum operating voltage, the maximum operating voltage becomes the rated voltage. 額定電壓超過最高使用電壓時，最高使用電壓為額定電壓</p>	<p>Maximum operating voltage 最高使用電壓</p>	<p>A.C 500V D.C 10V</p>
5	Residual resistance 殘留阻值	<p>Resistance at each end of the between terminals 1 - 2 and 2 - 3 shall be measured 摺動子在終端位置，在此時端子 1-2 間，端子 2-3 間測定之電阻值</p>	<p>Between 1-2 1-2 間 Less 5Ω 5Ω 以下</p>	<p>Between 2-3 2-3 間 Less 20Ω 20Ω 以下</p>
6	Noise 摺動雜音	<p>Refers to JIS C6443 依 JIS C6443 測定法</p>	<p>Less than 47mV 47 mV 以下</p>	
7	Insulation resistance 絕緣阻抗	<p>A voltage of 250 V DC shall be applied for 1 min, after which measurement shall be made. DC 250 V 1 分鐘</p>	<p>Between individual terminals and frame/shaft/lever. 在端子，固定架，把柄間</p>	<p>100MΩ or more 100MΩ 以上</p>

Item 項目	Conditions 條件		Specifications 規格
Dielectric strength 耐電壓	Trip current: 2mA Measuring frequency: 50/60 Hz 250AC for 1min 電流 2 mA 頻率 50/60 HZ AC 250 V 1 分鐘	Between individual terminals and frame/shaft/lever 在端子，固定架，把柄間	Without damage, arcing or breakdown to parts. 沒有損傷，變形，絕緣破壞等情形。
四: Endurance.耐環境性能			
Cold 耐寒性	The potentiometer shall be stored at a temperature of $-10\pm 2^{\circ}$ C for 96 hours in a temperature chamber. Then the potentiometer shall be taken out of the chamber and its surfacemoisture shall be removed. And then the potentiometer shall be subjected to standard atmospheric conditions for 1 hour, after which measurement shall be made. 溫度 $-10\pm 2^{\circ}$ C 恒溫槽中 96 小時放置後，置於常溫常濕 1 小時除去水滴後，1 小時內測定。		Change in total resistance Is relative to the value before test : $\pm 20\%$ 全阻值初期值 $\pm 20\%$
Dry heat 耐熱性	The potentiometer shall be stored at a temperature of $70\pm 2^{\circ}$ C for 240 ± 8 hours in a temperature chamber. Then the potentiometer shall be maintained at standard atmospheric conditions for 1 hour, after which measurement shall be made. 溫度 $70\pm 2^{\circ}$ C 恒溫箱中 240 ± 8 小時放置後，置於常溫常濕 1 小時除去水滴後，1 小時內測定。		Change in total resistance Is relative to the value before test : $\pm 5\sim 30\%$. Noise : less than 150mv. Operating force: < 50 gf. 全阻值初期值 $\pm 5\sim 30\%$. 雜音: 150mv 以下. 動作力: 50gf. 以下.
Damp heat 耐濕性	The potentiometer shall be stored at a temperature of $40\pm 2^{\circ}$ C with relative humidity of 90% to 95% for 96 ± 4 hours in a temperature chamber. Then the potentiometer shall be maintained at standard atmospheric conditions for 1 hour, after which measurement shall be made. 溫度 $40\pm 2^{\circ}$ C, 濕度 90-95% 恒溫恒濕槽中放置 96 ± 4 小時後，置於常溫常濕 1 小時除去水滴後，1 小時內測定。		Change in total resistance is relative to the value before test : $\pm 20\%$ Insulation resistance: $20M\Omega$ Noise : less than 150mv. Operating force: < 50 gf. 全阻值初值 $\pm 20\%$ 雜音: 150mv 以下. 絕緣電阻: $20M\Omega$ 以上. 動作力: 50gf. 以下
Change of Temperature 溫度循環	After 5 consecutive cycles of test conducted subject to below temperature condition, the measurement should be made within 1 hour upon potentiometer being dried under the ambient temperature and humidity for 1 hour. 以下表條件溫度連續 5 次循環的試驗後，置於常溫常溼 1 小時除去水滴後，1 小時內測定。		Change in total resistance is Relative to the vale before test: $\pm 20\%$ 全阻值初值 $\pm 20\%$
Order 順序		Temperature 溫度	Duration 試驗時間
1.		$-10\pm 3^{\circ}$ C	30 min 分
2.		Standard atmospheric conditions 常溫	10-15 min 分
3.		$70\pm 2^{\circ}$ C	30 min 分
4.		Standard atmospheric conditions 常溫	10-15 min 分

五:Caution 注意事項

1. Do not lock the lever for five seconds or more when the motor is supplied with electricity and do not use the motor under the overloaded condition.
Please use the master type potentiometer with safety device for protecting the over-current in a Motor drive circuit. Because part of the motor is heated excessively and the motor is burned out in case it is used under the overloaded condition continuously.
當馬達在通電情況下,於超負荷的狀態下,柄固定不動的時間不能超過5秒鐘,
若於長時間在超負荷情況下,電位器的部分地方就會發熱燒損,為了保證回路不被破壞,
請務必安裝保護本產品的過電流保護電路。
2. Do not supply the electricity which is not capable of driving the lever to the motor for ten seconds or more.(The value of current is approximately 1 to 300 mA in this case)
請勿施加無法驅動馬達之電流達10秒鐘或更久(此電流值約在1-300mA)
3. Please use the master type potentiometer with a motor-drive circuit which is capable of supplying the sufficient current. This current value is 900 mA.or less.
馬達之輸入電源回路,必須能提供900mA以下電流。
4. Do not use the master type potentiometer in the following atmospheric conditions.
Corrosive atmosphere: For example, H₂S, SO₂, NO₂, Cl₂
Do not use the master type potentiometer with the following materials.
Poison materials : Especially, siliconized materials, cyano materials formalin, phenolic materials.
在以下大氣條件和材料請不要使用上直滑式附馬達電位器。
腐蝕性空氣 L: 例如: H₂S, SO₂, NO₂, Cl₂
有害材料: 含矽原料, 甲醛水, 碳酸物。
5. Avoid storing the master type potentiometer in unusual atmosphere, for example, high Temperature, high humidity, and low temperature.
為避免損壞請不要將電位器放置於高溫. 高濕. 低溫等不正常的大氣條件下

六：PRECAUTION IN USE 注意事項

1. If it will be used the operating point away from the center line of the lever.

it should be shorter as possible.

使用時, 柄的中心線距離操作點愈近愈好

2. About the length of lever

If conditions permit. It is advisable to use the shortest possible lever.

The longer the length up to operating point the more unfavorable slide feeling

Will be given.

柄的長度

如果條件允許, 柄的長度愈短愈好。柄的中心線距離操作點的距離愈短其滑動手感愈好, 反之則滑動手感會愈差。

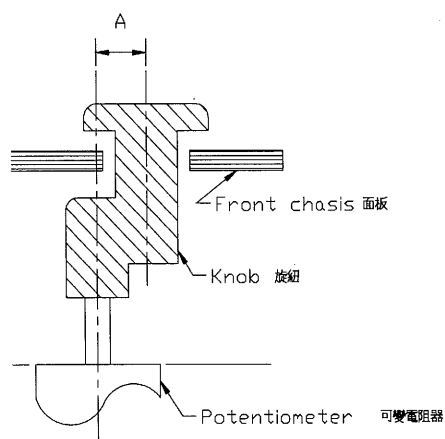

3. Regarding the operating of the lever. please consider the above mentioned, and make sure nothing is wrong with the operation under installing in your appliance that you plan to use our products actually. Knob assembly on the lever and functioning the lever to be performed under the condition of.P.C.B.without warp.

關於柄的操作, 請參考以上的說明, 並確保在實際使用的成品下操作無誤。柄組裝上旋鈕後並於印刷電路板(P.C.B.)上操作不會有扭曲變形的現象。

Motor drive characteristics 馬達運轉性能			
	Item 項目	Conditions 條件	Specifications 規格
1	Rated voltage 額定電壓	Between terminals of the motor 馬達的端子之間	D.C 5 V
2	Operating supply voltage range 使用電壓範圍	Voltage supply ripple: 0.3%or less 電壓變化率 0.3%	D.C 4-6 V
3	Starting current 起動電流	Supply voltage 5 V D.C 輸入電壓:D.C 5 V	800 mA or less 800 mA 以下
4	Starting force 起動作動力	Supply voltage 5 V D.C It shall be measured at the top of lever 測試位置在鐵柄的 先(頭)端位置	20 gf or more 20 gf 以上
5	Moving speed of lever 柄的移動速度	Supply voltage 5 V D.C 輸入電壓: D.C 5 V	20 mm / 0.1sec,or more 20 mm / 0.1 秒以上
6	Maximum current 最大電流	Lock the shaft of the motor and the rated voltage shall be applied to the motor 柄停止時,輸入額定電壓	1200 mA or less 1200 mA 以下

STANDARD RESISTANCE TAPER

B TAPER (JIS:B)

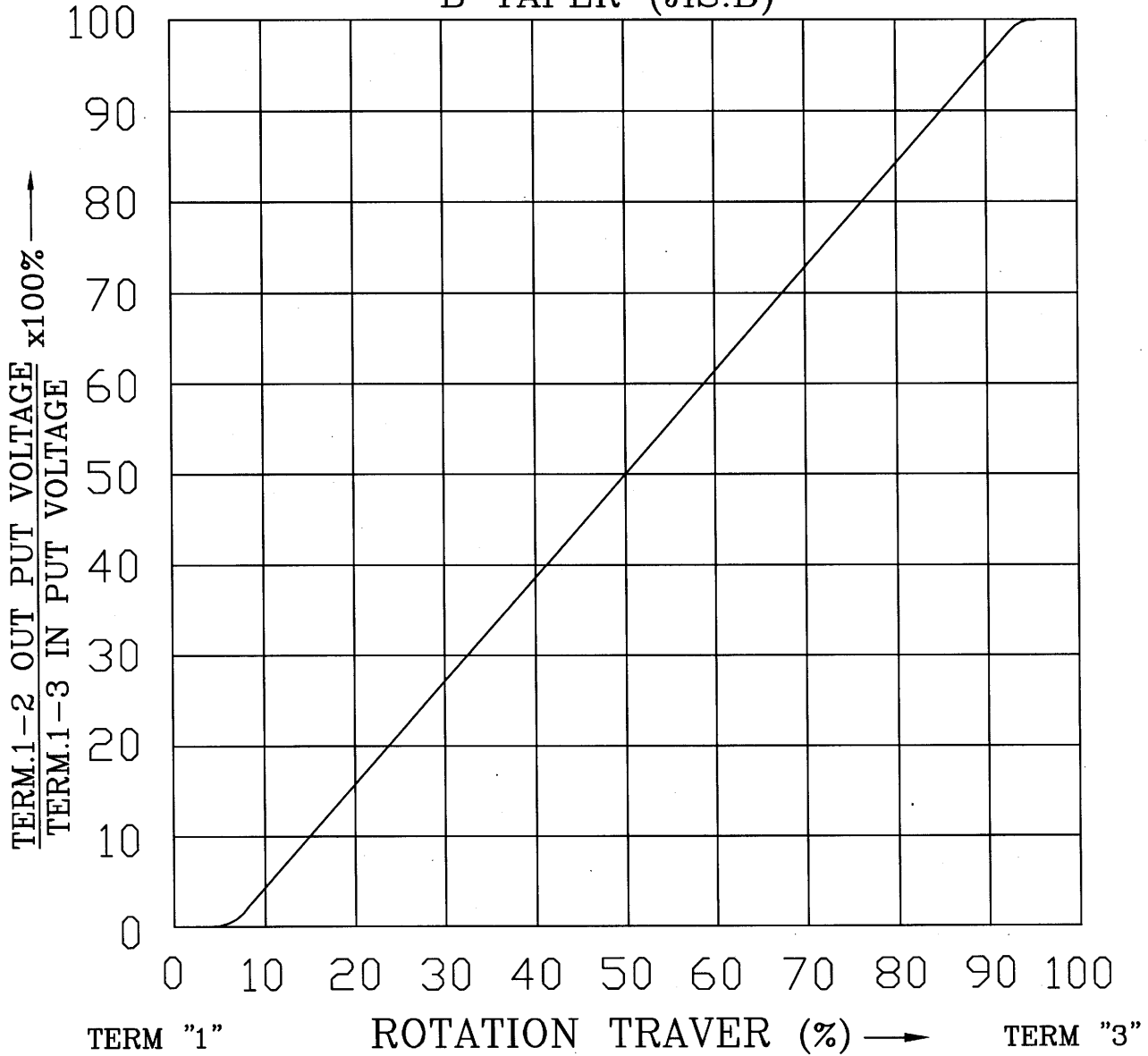

NO.	DATE	DESCRIPTION	MODEL NAME				
TOL. UNLESS OTHERWISE STATED		DIMENSION	SCALE	DRAWN BY	CHECKED BY	APPROVED BY	DRAWING NO.
less than	10	±0.3	mm	何 90.8.21 建志	王 90.8.21 茂松	王 90.8.21 茂松	
above	10 ~ 30	±0.5					
above	30 ~ 100	±1.0					
above		±5°					

可變電阻無鉛焊錫與保管條件共通規格書

Common Specification of Lead-Free Soldering and Storage conditions for Potentiometers

以下焊錫條件以可變電阻置於單層 1.6mm 厚度之印刷電路板上測試為基準。

The specification below is based on testing results of 1.6mm thickness single layer printed circuit board.

1. 手工焊錫條件：

For Manual Soldering：

1-1 操作溫度最高 350°C，操作時間 3 秒以內。

To be performed within 3 seconds at 350°C or below.

2. 自動或半自動機台焊錫條件：

For Automated or Semi-Automated Soldering Equipments:

2-1 使用發泡式且比重 0.82 以上的助焊劑，發泡高度以印刷電路板厚度一半為標準，且助劑不能流入可變電阻基板表面及印刷電路板表面。

Flux of 0.82 specific gravity, applied by foam fluxer, shall be used. Foam head shall be limited to the height which is half thickness of printed circuit board to be soldered. No flux should be allowed to run up onto resistive element board of potentiometer and the surface of printed circuit board.

2-2 預熱時間不超過兩分鐘，焊錫接面 (即印刷電路板底) 最高預熱溫度不超過 100°C。

Regarding preheating, the entire flow duration should not exceed 2 minutes, and soldering surface temperature (undersurface of PCB) shall be settled within 100°C.

2-3 焊錫過程機台設定溫度在 260°C 以下、4 秒以內。

Solder Dipping is to be performed within 4 seconds at 260°C or below.

3. 若回轉型電位器是塑膠軸且帶有檔位，請將主軸先調整至其中一個檔位或中心檔位上才可以進行焊錫作業。

For rotary potentiometer with plastic shaft which have centre detent or multiple detents, the shaft should be settled in relevant detent position prior to soldering process.

4. 手工焊錫、自動或半自動機台焊錫不得超過一回。

Regardless of soldering facility and method, solder dipping or solder smearing must not be carried out more than 1 time.

註：本項焊錫溫度條件不適用於回流焊接作業設備。

Remarks: This specification is not recommended for and applicable in reflow soldering.

焊錫注意事項：

Caution for soldering:

如圖所示，請避免 PCB 上層表面有焊錫

Please avoid soldering on upper surface of P.C.B. as shown.

5. 保管條件(Storage conditions):

產品需儲存在原始的包裝,以及保持常溫

常濕、避免陽光直射、遠離任何腐蝕性氣體。

產品需盡快完全地使用完,建議最慢不要超過

交貨後 6 個月。產品經拆封後，全部的數量都需迅速地使用完。

The products shall be stored in the original packaging and kept at room temperature and humidity, out of direct sunlight, and away from any and all corrosive gas. The products shall be completely used as soon as possible, but no longer than 6 months from the date of delivery. Once product packaging is opened, the complete quantity of such products shall be promptly used.

