

ExaMAX[®]

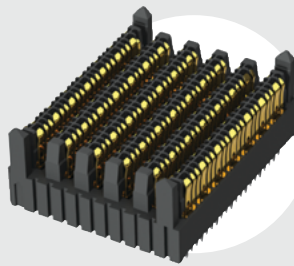

EBTM-6-12-2.0-S-VT-1

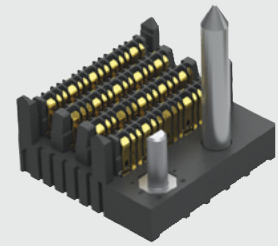

EBTM-4-08-2.0-S-VT-1-L-G

(2.00 mm) .0787"

ExaMAX[®] BACKPLANE SYSTEM

SPECIFICATIONS

For complete specifications and recommended PCB layouts see www.samtec.com?EBTM-VT or www.samtec.com?EBTM-RA

Insulator Material: Liquid Crystal Polymer
Contact Material: Copper Alloy

Plating: Sn or Au over 50 μm (1.27 μm) Ni
Operating Temp Range: -55 °C to +85 °C
Current Rating: 4.2 A per pin (1 pin powered)
Contact Wipe: 2.4 mm
RoHS Compliant: Yes

Mates with:
EBTF-RA

PAM 4
56 Gbps

APPLICATION

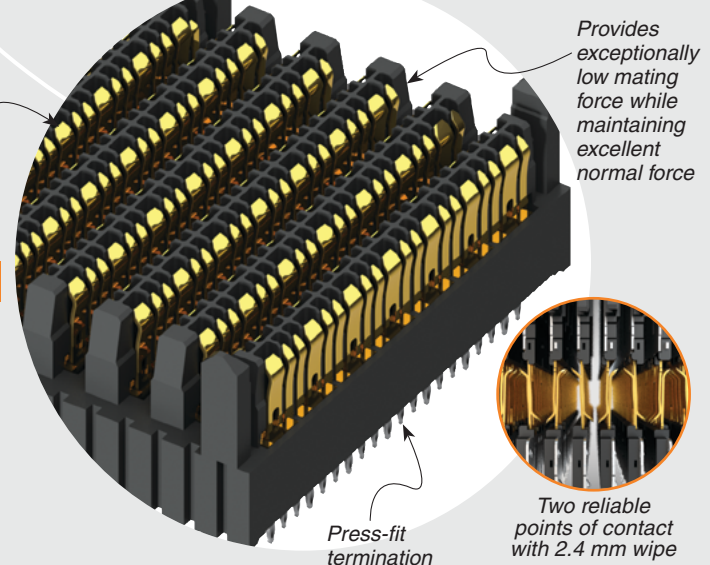

Two reliable points of contact with 2.4 mm wipe

RECOGNITIONS

For complete scope of recognitions see www.samtec.com/quality



EBTM	NO. OF PAIRS PER COLUMN	COLUMNS	COLUMN PITCH
	-4 = 4 Pairs	-06	-2.0 = (2.0 mm) .0787"
	-6 = 6 Pairs	-08	
		-10	
		-12 (-6 pairs only)	

ALSO AVAILABLE (MOQ Required)

- Staging

TOOLING

- For press-fit extraction and insertion tool options, visit www.samtec.com/tooling

GUIDANCE (EBTM-VT)	KEYING							
	-A	-B	-C	-D	-E	-F	-G	-H
-L/-R								

COLUMNS	A	B	C
-06	(11.90) .469	(10.00) .394	(18.35) .722
-08	(15.90) .626	(14.00) .551	(22.35) .880
-10	(19.90) .783	(18.00) .709	(26.35) 1.037
-12	(23.90) .941	(22.00) .866	(30.35) 1.195

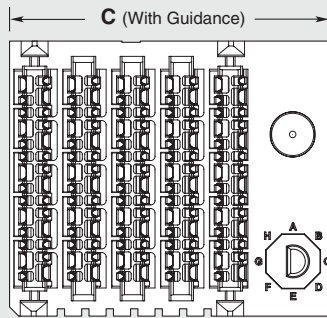

NO. OF PAIRS PER COLUMN	D	E
-4	(22.50) .886	(15.60) .614
-6	(29.70) 1.169	(22.80) .898

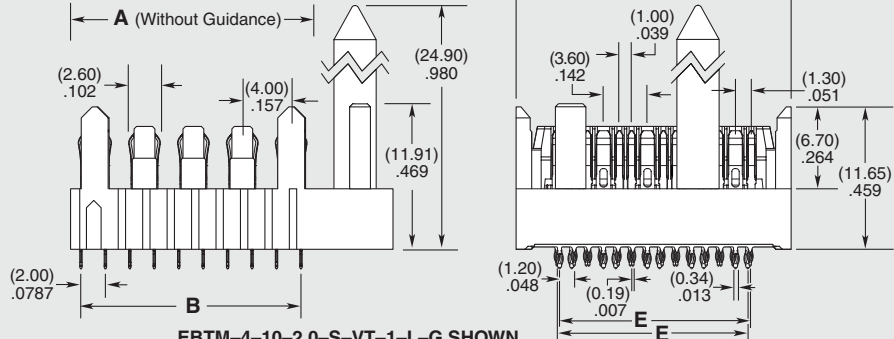

EBTM-4-10-2.0-S-VT-1-L-G SHOWN

Notes: Some lengths, styles and options are non-standard, non-returnable.

ExaMAX[®] is a registered trademark of AFCL.

Due to technical progress, all designs, specifications and components are subject to change without notice.

WWW.SAMTEC.COM

All parts within this catalog are built to Samtec's specifications. Customer specific requirements must be approved by Samtec and identified in a Samtec customer-specific drawing to apply.

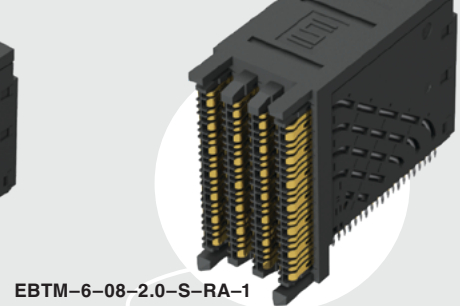
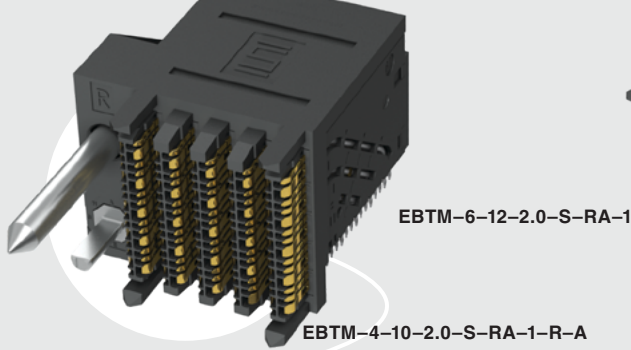

EBTM-VT, EBTM-RA SERIES

Guidance

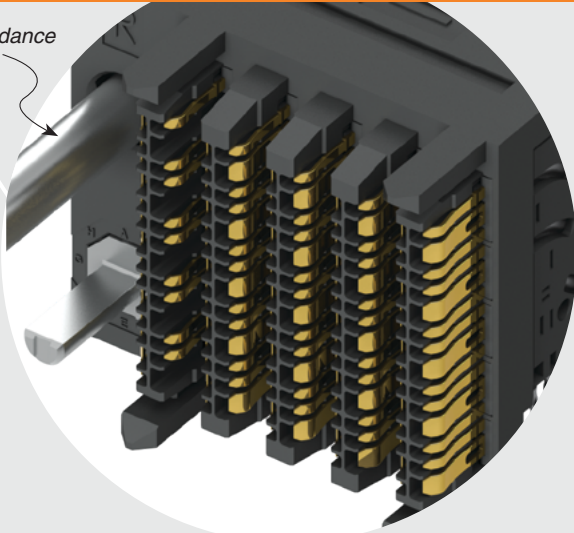

Press-fit termination

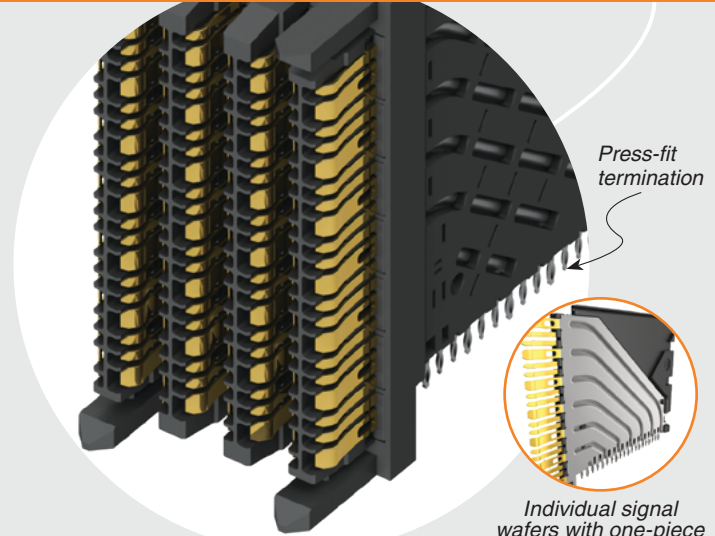

Individual signal wafers with one-piece ground plane

PLATING

-S
= 30 μ" (0.76 μm)
Gold on contact area,
Matte Tin on tail

ORIENTATION

-VT
= Vertical
-RA
= Right-angle

1

GUIDANCE

(Leave Blank for no Guidance)

-L = Left Guidance
-R = Right Guidance

KEYING

(Only available with -L or -R guidance)

(Leave Blank for no keying)

-A thru -H
= Position of flat on Key
(See table for Key)

COLUMNS	A	B
-06	(11.90) .469	(18.35) .722
-08	(15.90) .626	(22.35) .880
-10	(19.90) .783	(26.35) 1.037
-12	(23.90) .941	(30.35) 1.195

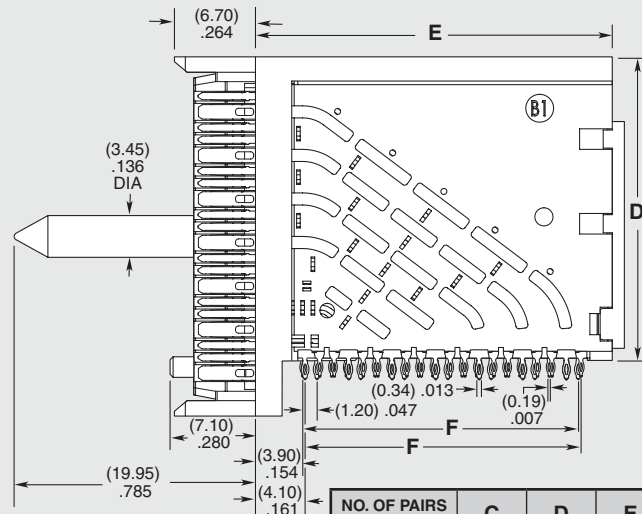
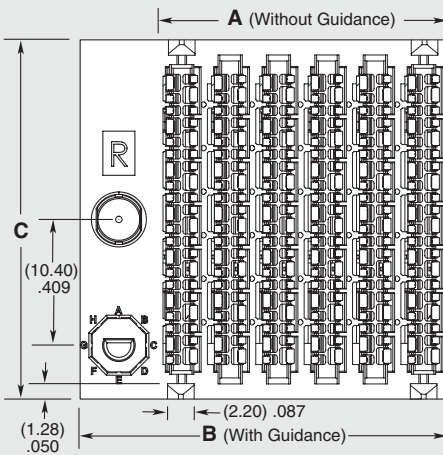

EBTM-6-12-2.0-S-RA-1-R-A SHOWN

GUIDANCE (EBTM-RA)	KEYING							
	-A	-B	-C	-D	-E	-F	-G	-H
-R / -L								

NO. OF PAIRS PER COLUMN	C	D	E	F
-4	(22.50) .886	(17.90) .705	(23.30) .917	(15.60) .614
-6	(29.70) 1.169	(25.10) .988	(30.50) 1.201	(22.80) .898

Due to technical progress, all designs, specifications and components are subject to change without notice.

WWW.SAMTEC.COM

All parts within this catalog are built to Samtec's specifications.
Customer specific requirements must be approved by Samtec and identified in a Samtec customer-specific drawing to apply.