

## ISL85403EVAL2Z

### Evaluation Board User Guide

UG010  
Rev 1.00  
February 2, 2015

## Description

The ISL85403EVAL2Z board allows quick evaluation of the ISL85403 in the noninverting buck-boost configuration. It is a cost effective solution for the low-power, wide input voltage range point-of-load application where both stepping up and stepping down voltage capabilities are required.

## Specifications

The design specifications of the ISL85403EVAL2Z are shown in [Table 1](#).

TABLE 1. SPECIFICATIONS

PARAMETERS	VALUES
Input Voltage ( $V_{IN}$ )	8V to 40V
Output Voltage ( $V_{OUT}$ )	12.0V
Max. Output Current (IOUT_MAX)	1A
Switching Frequency	500kHz
Output Ripple	360mV at 1A Load

## Key Features

- Small, compact design
- $V_{IN}$  range of 8V to 40V
- Convenient power connection

## References

[ISL85403](#) Datasheet

## Ordering Information

PART NUMBER	DESCRIPTION
ISL85403EVAL2Z	ISL85403 Evaluation Board, buck-boost configuration 12V output

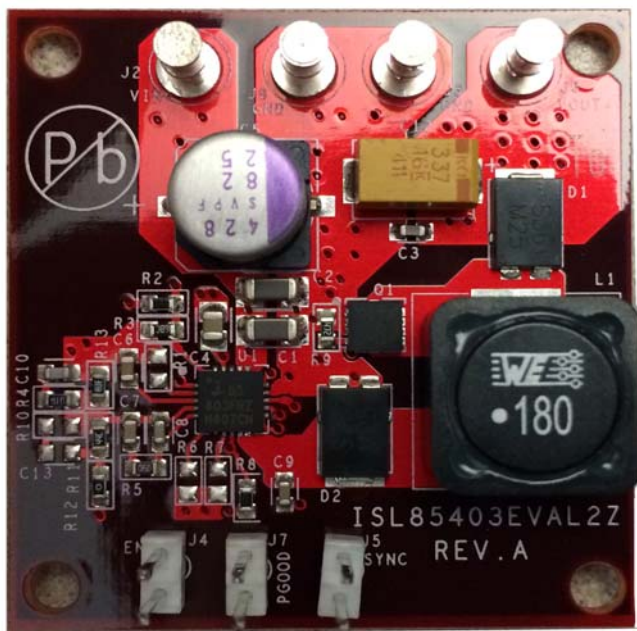

FIGURE 1. TOP VIEW



FIGURE 2. BOTTOM VIEW

## Functional Description

The ISL85403 is a flexible switching regulator with an integrated 127mΩ high-side MOSFET. It can be used as a synchronous buck converter, a 2-stage boost-buck converter, or a noninverting buck-boost converter.

The ISL85403EVAL2Z board demonstrates the operations of the ISL85403 in the noninverting buck-boost configuration. The ISL85403EVAL2Z board is shown in [Figures 1](#) and [2](#).

The schematic is shown on [page 4](#), bill of materials on [page 4](#), and PCB layers for reference start on [page 7](#). [Figures 4](#) through [15](#) show performance data taken from the evaluation board.

## Operating Range

The board input voltage range is 8V to 40V. The output voltage is set to 12V and can be changed by voltage feedback resistors R<sub>11</sub> and R<sub>13</sub>, as shown in [Equation 1](#):

$$R_{13} = R_{11} \cdot \frac{V_{ref}}{V_{OUT} - V_{ref}} \quad (\text{EQ. 1})$$

Note: In order to change to a higher output voltage, the output capacitors have to be changed for the higher voltage rating.

The board is set to a default frequency of 500kHz (FS pin/R<sub>1</sub> is open). The switching frequency can be programmed to other values by a resistor at R<sub>1</sub>. Refer to the [ISL85403](#) datasheet for the resistor value and the switching frequency. The switching frequency can also be synchronized to external clock by connecting the external clock to the SYNC terminal (J5).

## Inductor Current

In the noninverting buck-boost configuration, the inductor current (I<sub>L</sub>) can be expressed as:

$$I_L = I_{OUT} \cdot \frac{V_{OUT} + V_{IN}}{V_{IN}} \quad (\text{EQ. 2})$$

The maximum inductor current happens at the condition of the minimum input voltage and the maximum output current. The inductor used in this noninverting buck-boost configuration should have saturation current higher than the maximum inductor current.

$$I_{L, sat} > I_{OUT, max} \cdot \frac{V_{OUT} + V_{IN, min}}{V_{IN, min}} \quad (\text{EQ. 3})$$

## PCB Layout Guidelines

1. Place the input ceramic capacitors as closely as possible to the IC VIN pin and power ground connecting to the power diode. Keep this loop (input ceramic capacitor, IC VIN pin and diode) as small as possible to minimize the voltage spikes induced by the trace parasitic inductance. A bulk capacitor, C5 (as shown in the [“ISL85403EVAL2Z Circuit Schematic”](#) on [page 3](#)), is included to support long wire connections from power supplies to the evaluation board.
2. Keep the phase node copper area small but large enough to handle the load current.
3. On the output side, place the output ceramic capacitors as closely as possible to the cathode of the power diode and the

source of the MOSFET. Keep this loop (output ceramic capacitor, MOSFET and diode) as small as possible to minimize the voltage spikes induced by the trace parasitic inductance.

4. Place the output ceramic and aluminum capacitors close to the power stage components as well.
5. Place vias (at least 9) in the bottom pad of the IC. The bottom pad should be placed in ground copper plane with an area as large as possible in multiple layers to effectively reduce the thermal impedance.
6. Place the 4.7μF ceramic decoupling capacitor (C4 as shown in the [“ISL85403EVAL2Z Circuit Schematic”](#) on [page 3](#)) as close as possible to the IC's VCC pin. Put multiple vias close to the ground pad of this capacitor.
7. Keep the bootstrap capacitor close to the IC.
8. Keep the LGATE drive trace as short as possible and try to avoid using vias in the LGATE drive path to achieve the lowest impedance.
9. Place the output voltage sense trace close to the place that is to be strictly regulated.
10. Place all the peripheral control components close to the IC.

## Quick Test Setup

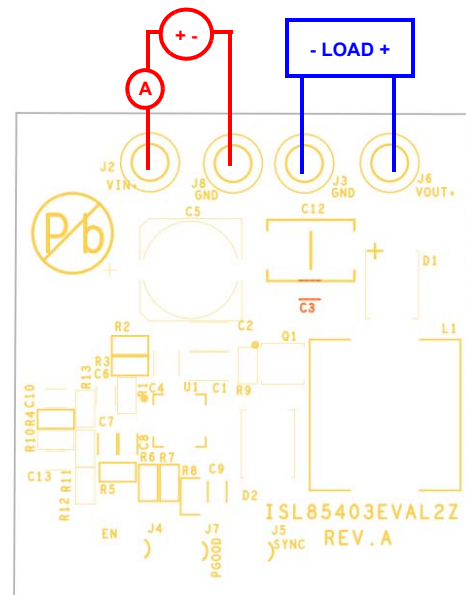

FIGURE 3. ISL85403EVAL2Z BOARD SETUP

1. Connect the power supply to the input terminals VIN (J2) and GND (J8). Connect the load terminals to the output VOUT (J6) and GND (J3). Make sure the setup is correct prior to applying any power or load to the board.
2. Adjust the power supply to 8V to 40V and turn it on.
3. Verify the output voltage is 12V and use oscilloscope to monitor the phase node waveforms.



## Bill of Materials

REF DES	PART NUMBER	QTY	DESCRIPTION	MANUFACTURER
C5	HHXA630ARA330MHA0G	1	Aluminum Electrolytic Capacitor, SMD, 8x10, 33 $\mu$ F, 63V, 20%, 40m $\Omega$ , ROHS	UNITED CHEMI-CON
C6	VARIOUS	1	CAP, SMD, 0603, 0.1 $\mu$ F, 50V, 10%, X7R, ROHS	VARIOUS
C3	VARIOUS	1	CAP, SMD, 0603, 1 $\mu$ F, 16V, 10%, X5R, ROHS	VARIOUS
C9	VARIOUS	1	CAP, SMD, 0603, 0.22 $\mu$ F, 25V, 10%, X7R, ROHS	VARIOUS
C10	VARIOUS	1	CAP, SMD, 0603, 470pF, 50V, 5%, NPO, ROHS	VARIOUS
C7	VARIOUS	1	CAP, SMD, 0603, 4700pF, 50V, 10%, X7R, ROHS	VARIOUS
C8	VARIOUS	1	CAP, SMD, 0603, 68pF, 50V, 10%, NPO, ROHS	VARIOUS
C1, C2	VARIOUS	2	CAP, SMD, 1206, 4.7 $\mu$ F, 50V, 10%, X5R, ROHS	VARIOUS
C12	T521X337M016ATE025	1	CAP-TANT, LOW-ESR, SMD, 7.3x4.3x4, 330 $\mu$ F, 16V, 20%, 25m $\Omega$ , ROHS	KEMET
D1, D2	SS6P3LHM3/86A	2	DIODE-SCHOTTKY RECTIFIER, SMD, SMPC, 60V, 3A, ROHS	VISHAY
L1	744770118	1	COIL-PWR INDUCTOR, SMD, 12mm, 18 $\mu$ H, 20%, 4.2A, 0.032 $\Omega$ , ROHS	WURTH
U1	ISL85403IRZ	1	IC-SWITCHING REGULATOR, 20P, QFN, 4X4, ROHS	INTERSIL
Q1	BSZ100N06LS3G	1	TRANSIST-MOS, N-CHANNEL, 8P, PG-TSDSON-8, 60V, 20A, ROHS	INFINEON
R2	VARIOUS	1	RES, SMD, 0603, 348k, 1/10W, 1%, TF, ROHS	VARIOUS
R3	VARIOUS	1	RES, SMD, 0603, 49.9k, 1/10W, 1%, TF, ROHS	VARIOUS
R4	VARIOUS	1	RES, SMD, 0603, 100 $\Omega$ , 1/10W, 1%, TF, ROHS	VARIOUS
R5	VARIOUS	1	RES, SMD, 0603, 113k, 1/10W, 1%, TF, ROHS	VARIOUS
R8	VARIOUS	1	RES, SMD, 0603, 200k, 1/10W, 1%, TF, ROHS	VARIOUS
R9	VARIOUS	1	RES, SMD, 0603, 4.7k, 1/10W, 1%, TF, ROHS	VARIOUS
R11	VARIOUS	1	RES, SMD, 0603, 28k, 1/10W, 1%, TF, ROHS	VARIOUS
R12	VARIOUS	1	RES, SMD, 0603, 0 $\Omega$ , 1/10W, 1%, TF, ROHS	VARIOUS
R13	VARIOUS	1	RES, SMD, 0603, 2k, 1/10W, 1%, TF, ROHS	VARIOUS
R1, R6, R7, R10, C13	N/A	0	Do not populate	N/A

# Typical Performance Curves

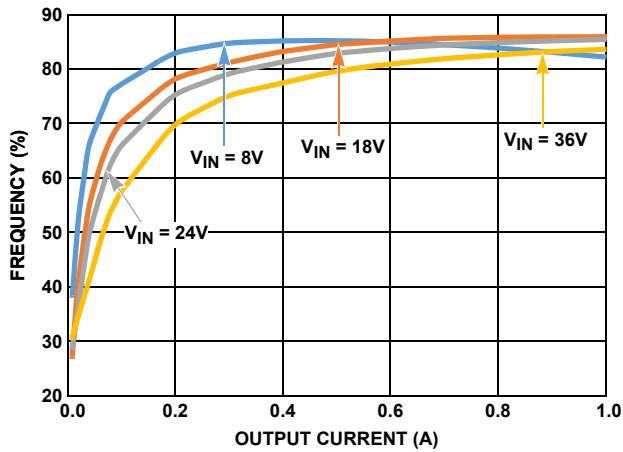

FIGURE 4. EFFICIENCY vs LOAD

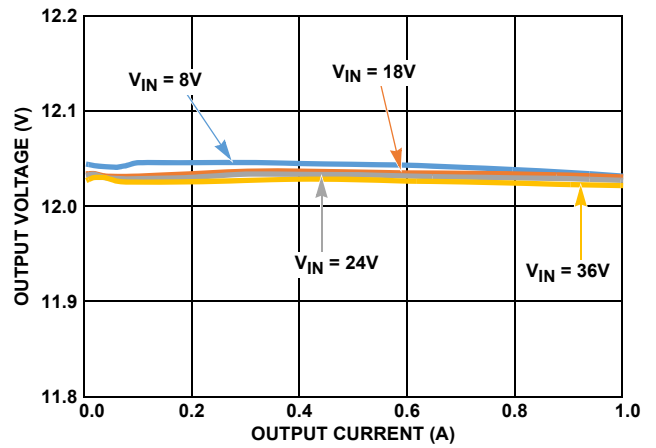

FIGURE 5. LOAD REGULATION

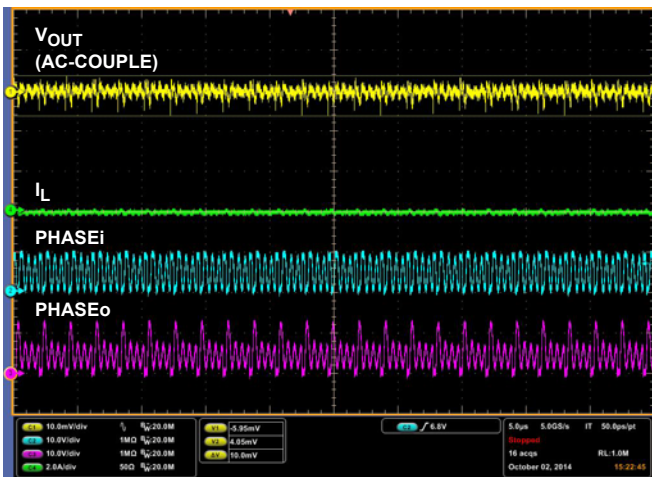

FIGURE 6. OUTPUT RIPPLE AT 0A LOAD ( $V_{IN} = 8V$ )

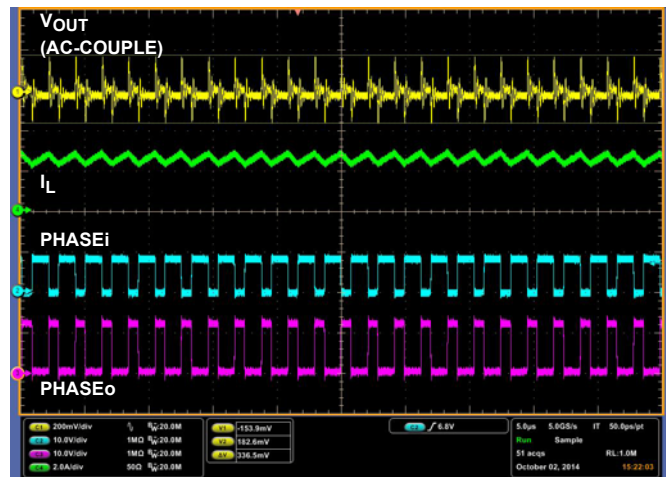

FIGURE 7. OUTPUT RIPPLE AT 1A LOAD ( $V_{IN} = 8V$ )

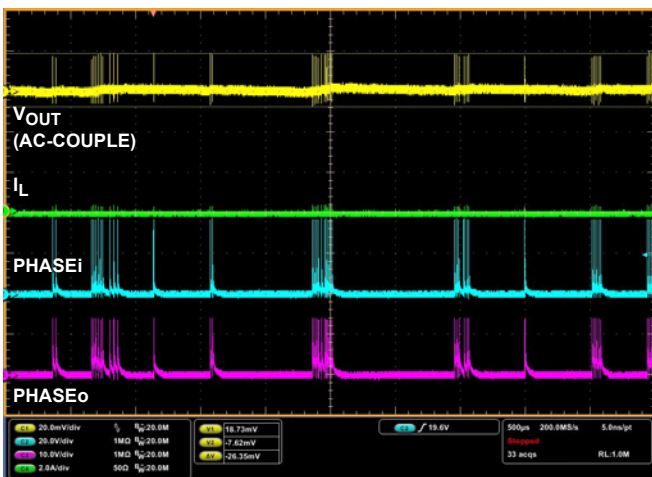

FIGURE 8. OUTPUT RIPPLE AT 0A LOAD ( $V_{IN} = 36V$ )

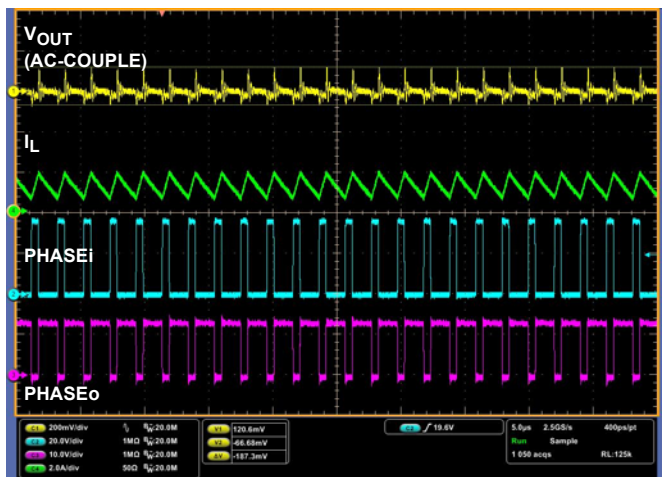

FIGURE 9. OUTPUT RIPPLE AT 1A LOAD ( $V_{IN} = 36V$ )

### Typical Performance Curves (Continued)

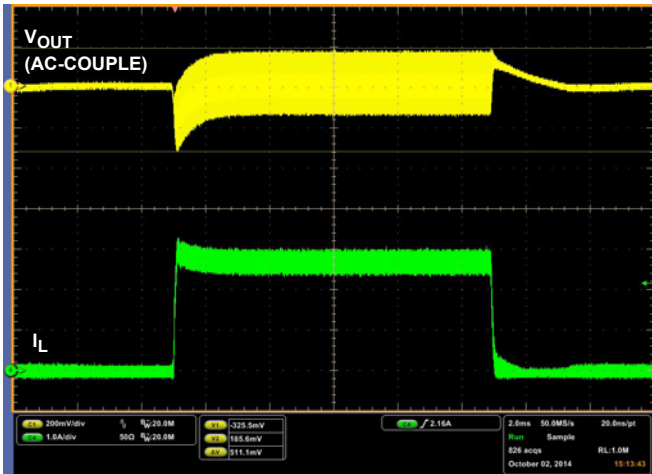

FIGURE 10. LOAD TRANSIENT RESPONSE 0A->1A, VIN = 8V



FIGURE 11. LOAD TRANSIENT RESPONSE 0A->1A, VIN = 36V

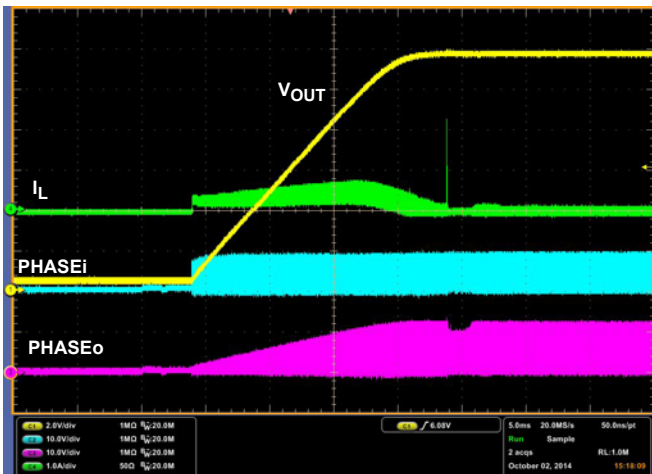

FIGURE 12. SOFT-START AT 0A LOAD (VIN = 8V)

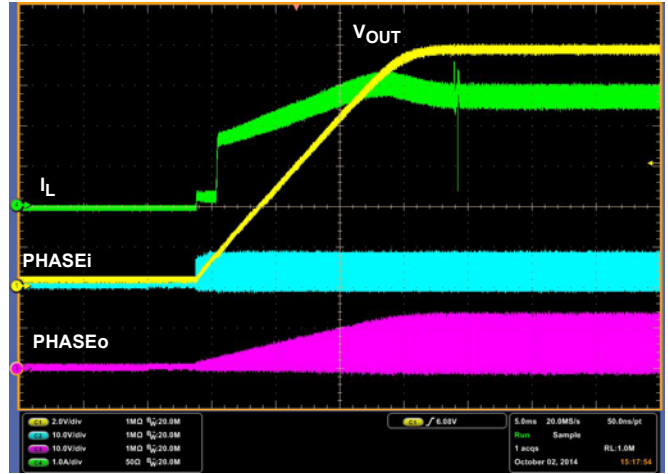

FIGURE 13. SOFT-START AT 1A LOAD (VIN = 8V)

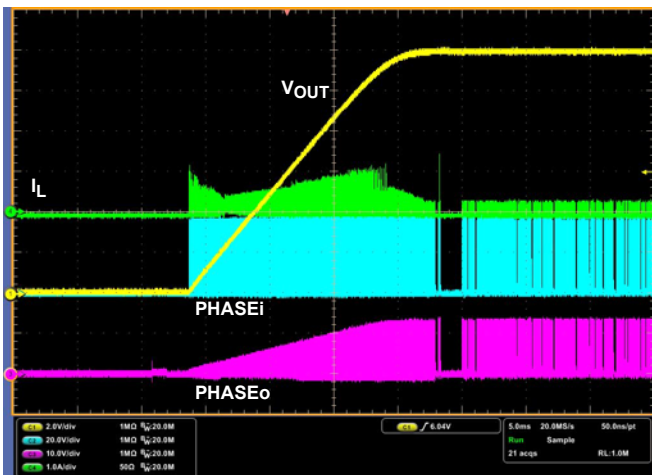

FIGURE 14. SOFT-START AT 0A LOAD (VIN = 36V)

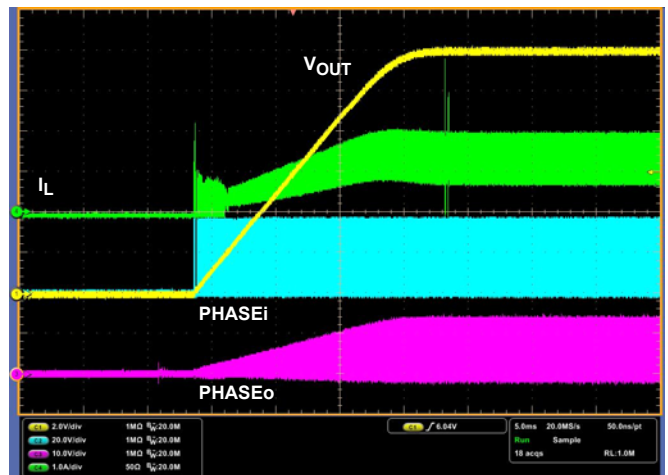

FIGURE 15. SOFT-START AT 1A LOAD (VIN = 36V)

# Board Layout

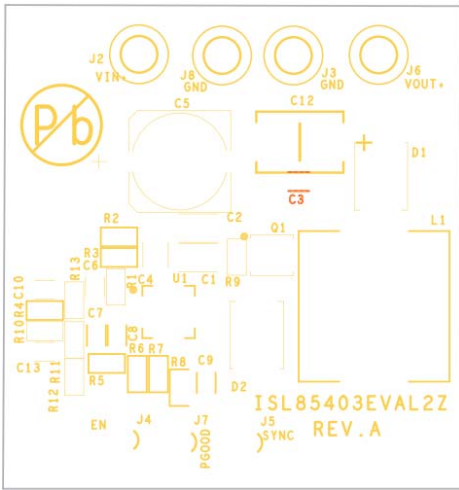

FIGURE 16. SILKSCREEN TOP

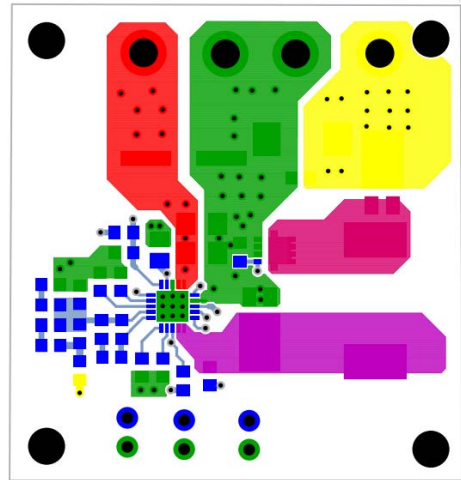

FIGURE 17. TOP LAYER

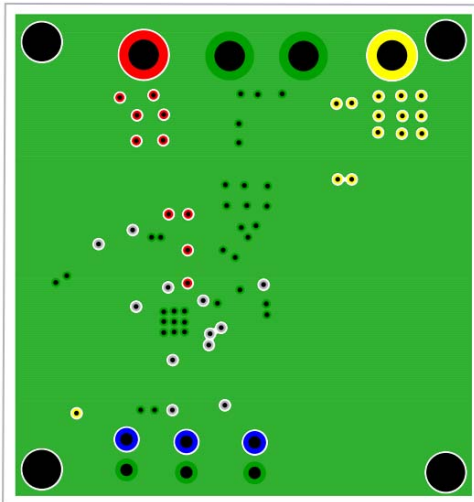

FIGURE 18. LAYER 2

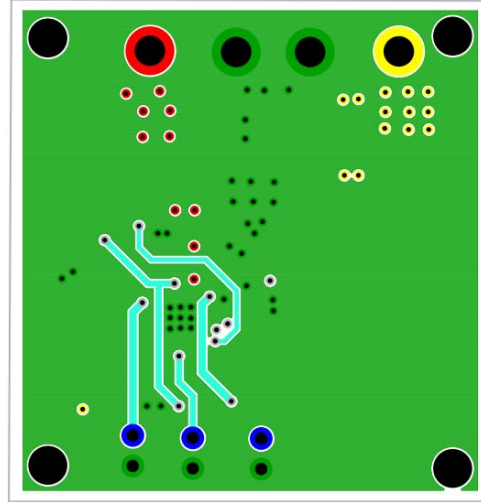

FIGURE 19. LAYER 3

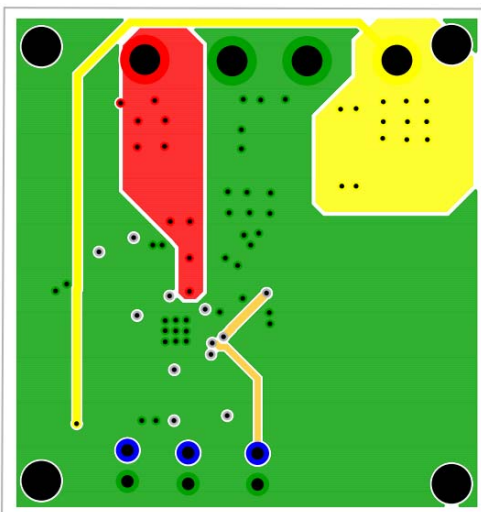

FIGURE 20. BOTTOM LAYER



FIGURE 21. SILKSCREEN BOTTOM

## Notice

1. Descriptions of circuits, software and other related information in this document are provided only to illustrate the operation of semiconductor products and application examples. You are fully responsible for the incorporation or any other use of the circuits, software, and information in the design of your product or system. Renesas Electronics disclaims any and all liability for any losses and damages incurred by you or third parties arising from the use of these circuits, software, or information.
2. Renesas Electronics hereby expressly disclaims any warranties against and liability for infringement or any other claims involving patents, copyrights, or other intellectual property rights of third parties, by or arising from the use of Renesas Electronics products or technical information described in this document, including but not limited to, the product data, drawings, charts, programs, algorithms, and application examples.
3. No license, express, implied or otherwise, is granted hereby under any patents, copyrights or other intellectual property rights of Renesas Electronics or others.
4. You shall not alter, modify, copy, or reverse engineer any Renesas Electronics product, whether in whole or in part. Renesas Electronics disclaims any and all liability for any losses or damages incurred by you or third parties arising from such alteration, modification, copying or reverse engineering.
5. Renesas Electronics products are classified according to the following two quality grades: "Standard" and "High Quality". The intended applications for each Renesas Electronics product depends on the product's quality grade, as indicated below.  
"Standard": Computers; office equipment; communications equipment; test and measurement equipment; audio and visual equipment; home electronic appliances; machine tools; personal electronic equipment; industrial robots; etc.  
"High Quality": Transportation equipment (automobiles, trains, ships, etc.); traffic control (traffic lights); large-scale communication equipment; key financial terminal systems; safety control equipment; etc.  
Unless expressly designated as a high reliability product or a product for harsh environments in a Renesas Electronics data sheet or other Renesas Electronics document, Renesas Electronics products are not intended or authorized for use in products or systems that may pose a direct threat to human life or bodily injury (artificial life support devices or systems; surgical implantations; etc.), or may cause serious property damage (space system; undersea repeaters; nuclear power control systems; aircraft control systems; key plant systems; military equipment; etc.). Renesas Electronics disclaims any and all liability for any damages or losses incurred by you or any third parties arising from the use of any Renesas Electronics product that is inconsistent with any Renesas Electronics data sheet, user's manual or other Renesas Electronics document.
6. When using Renesas Electronics products, refer to the latest product information (data sheets, user's manuals, application notes, "General Notes for Handling and Using Semiconductor Devices" in the reliability handbook, etc.), and ensure that usage conditions are within the ranges specified by Renesas Electronics with respect to maximum ratings, operating power supply voltage range, heat dissipation characteristics, installation, etc. Renesas Electronics disclaims any and all liability for any malfunctions, failure or accident arising out of the use of Renesas Electronics products outside of such specified ranges.
7. Although Renesas Electronics endeavors to improve the quality and reliability of Renesas Electronics products, semiconductor products have specific characteristics, such as the occurrence of failure at a certain rate and malfunctions under certain use conditions. Unless designated as a high reliability product or a product for harsh environments in a Renesas Electronics data sheet or other Renesas Electronics document, Renesas Electronics products are not subject to radiation resistance design. You are responsible for implementing safety measures to guard against the possibility of bodily injury, injury or damage caused by fire, and/or danger to the public in the event of a failure or malfunction of Renesas Electronics products, such as safety design for hardware and software, including but not limited to redundancy, fire control and malfunction prevention, appropriate treatment for aging degradation or any other appropriate measures. Because the evaluation of microcomputer software alone is very difficult and impractical, you are responsible for evaluating the safety of the final products or systems manufactured by you.
8. Please contact a Renesas Electronics sales office for details as to environmental matters such as the environmental compatibility of each Renesas Electronics product. You are responsible for carefully and sufficiently investigating applicable laws and regulations that regulate the inclusion or use of controlled substances, including without limitation, the EU RoHS Directive, and using Renesas Electronics products in compliance with all these applicable laws and regulations. Renesas Electronics disclaims any and all liability for damages or losses occurring as a result of your noncompliance with applicable laws and regulations.
9. Renesas Electronics products and technologies shall not be used for or incorporated into any products or systems whose manufacture, use, or sale is prohibited under any applicable domestic or foreign laws or regulations. You shall comply with any applicable export control laws and regulations promulgated and administered by the governments of any countries asserting jurisdiction over the parties or transactions.
10. It is the responsibility of the buyer or distributor of Renesas Electronics products, or any other party who distributes, disposes of, or otherwise sells or transfers the product to a third party, to notify such third party in advance of the contents and conditions set forth in this document.
11. This document shall not be reprinted, reproduced or duplicated in any form, in whole or in part, without prior written consent of Renesas Electronics.
12. Please contact a Renesas Electronics sales office if you have any questions regarding the information contained in this document or Renesas Electronics products.  
(Note 1) "Renesas Electronics" as used in this document means Renesas Electronics Corporation and also includes its directly or indirectly controlled subsidiaries.  
(Note 2) "Renesas Electronics product(s)" means any product developed or manufactured by or for Renesas Electronics.

(Rev.4.0-1 November 2017)



### SALES OFFICES

Renesas Electronics Corporation

<http://www.renesas.com>

Refer to "<http://www.renesas.com/>" for the latest and detailed information.

**Renesas Electronics America Inc.**  
1001 Murphy Ranch Road, Milpitas, CA 95035, U.S.A.  
Tel: +1-408-432-8888, Fax: +1-408-434-5351

**Renesas Electronics Canada Limited**  
9251 Yonge Street, Suite 8309 Richmond Hill, Ontario Canada L4C 9T3  
Tel: +1-905-237-2004

**Renesas Electronics Europe Limited**  
Dukes Meadow, Millboard Road, Bourne End, Buckinghamshire, SL8 5FH, U.K  
Tel: +44-1628-651-700, Fax: +44-1628-651-804

**Renesas Electronics Europe GmbH**  
Arcadiastrasse 10, 40472 Düsseldorf, Germany  
Tel: +49-211-6503-0, Fax: +49-211-6503-1327

**Renesas Electronics (China) Co., Ltd.**  
Room 1709 Quantum Plaza, No.27 ZhichunLu, Haidian District, Beijing, 100191 P. R. China  
Tel: +86-10-8235-1155, Fax: +86-10-8235-7679

**Renesas Electronics (Shanghai) Co., Ltd.**  
Unit 301, Tower A, Central Towers, 555 Langao Road, Putuo District, Shanghai, 200333 P. R. China  
Tel: +86-21-2226-0888, Fax: +86-21-2226-0999

**Renesas Electronics Hong Kong Limited**  
Unit 1601-1611, 16/F., Tower 2, Grand Century Place, 193 Prince Edward Road West, Mongkok, Kowloon, Hong Kong  
Tel: +852-2265-6688, Fax: +852-2886-9022

**Renesas Electronics Taiwan Co., Ltd.**  
13F, No. 363, Fu Shing North Road, Taipei 10543, Taiwan  
Tel: +886-2-8175-9600, Fax: +886-2-8175-9670

**Renesas Electronics Singapore Pte. Ltd.**  
80 Bendemeer Road, Unit #06-02 Hyflux Innovation Centre, Singapore 339949  
Tel: +65-6213-0200, Fax: +65-6213-0300

**Renesas Electronics Malaysia Sdn.Bhd.**  
Unit 1207, Block B, Menara Amcorp, Amcorp Trade Centre, No. 18, Jln Persiaran Barat, 46050 Petaling Jaya, Selangor Darul Ehsan, Malaysia  
Tel: +60-3-7955-9390, Fax: +60-3-7955-9510

**Renesas Electronics India Pvt. Ltd.**  
No.777C, 100 Feet Road, HAL 2nd Stage, Indiranagar, Bangalore 560 038, India  
Tel: +91-80-67208700, Fax: +91-80-67208777

**Renesas Electronics Korea Co., Ltd.**  
17F, KAMCO Yangjae Tower, 262, Gangnam-daero, Gangnam-gu, Seoul, 06265 Korea  
Tel: +82-2-558-3737, Fax: +82-2-558-5338