

1 2 3 4 5 6

A

B

C

D

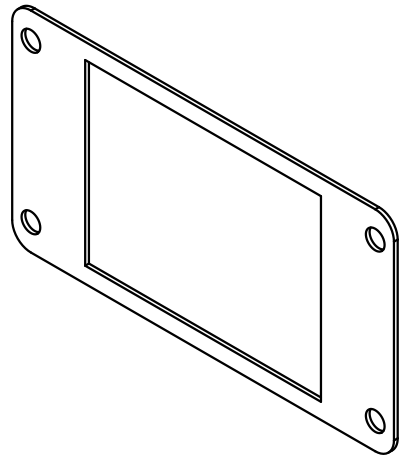
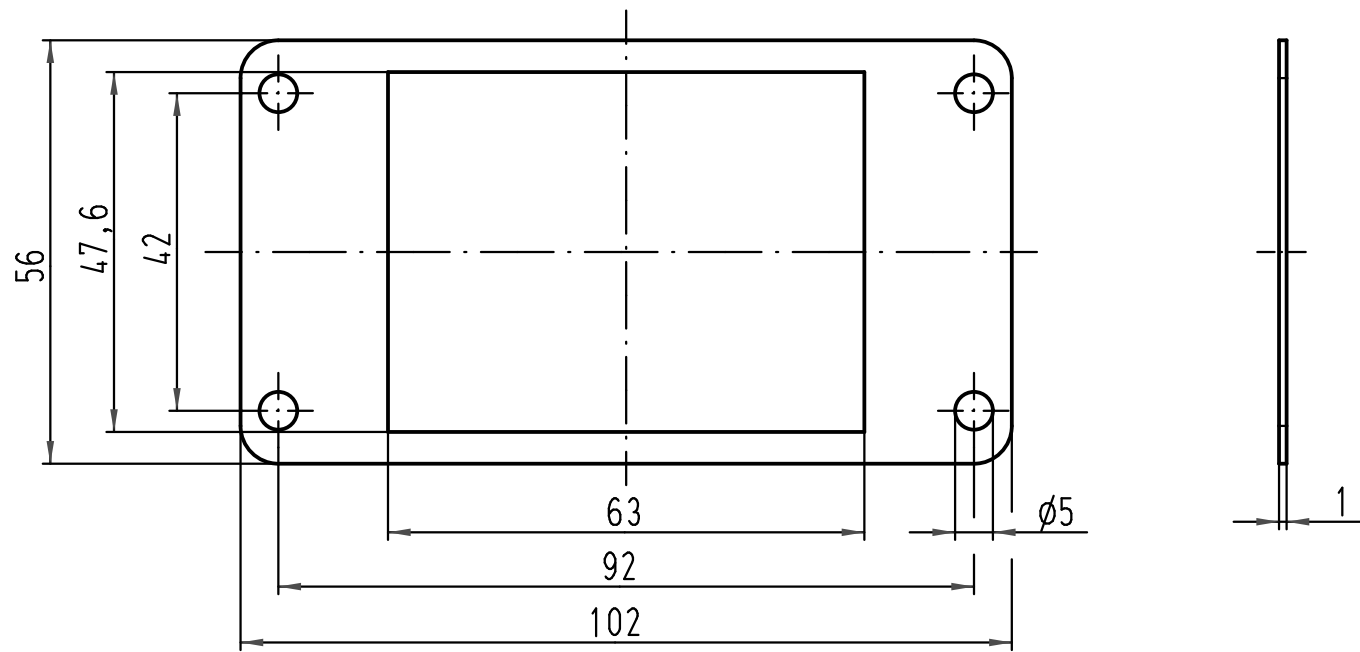

All Dimensions in mm Original Size DIN A 4		Techn. Character.			Nicht tolerierte Masse/ Free size tolerances		
			Dat.	Name	Maßstab/ Scale 1:1	Flanschgummidichtung Han 32A <i>gasket Han 32A</i>	
			Detail.	09.08.07			Ho
			Insp.				Sch
			Stand.				
413111			HARTING Electric GmbH & Co. KG			TB 09 20 000 9994 Sub.	
Mod.	Dat.	Name	D-32339 Espelkamp				
						Blatt/ page	