

PTR016V

16 Volt DC radial leaded, PolyTron™ PTC devices

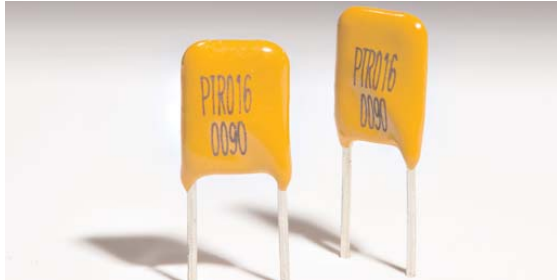

Product features

- PolyTron™ radial leaded thru-hole PTC device
- Maximum 16 V
- Current ratings from 0.9 A to 15 A
- Fast time-to-trip
- Low resistance
- Halogen free, lead free, RoHS compliant

Applications

- Medical equipment
- Telecommunications
- White goods
- Computers and peripherals

Agency information

- cURus: Recognized Card: File E343021 (Ihold 3A-15 A)
- TUV File: J 50194729

Ordering information/ part number system

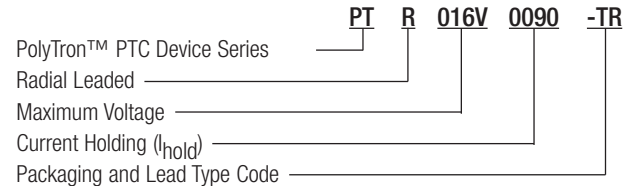

Lead Codes: TR & BK - Straight Leads, TR1 & BK1 - Kinked Leads

TR & TR1 On Reels

- 0.9-1.85 A - 3000 devices
- 2.5-4 A - 2500 devices
- 5-7 A - 1500 devices
- 8-15 A - 1000 devices

BK & BK1 In Poly Bags

- 0.9-1.60 A - 1000 devices
- 1.85-9.00 A - 500 devices
- 10.00-15.00 A - 250 devices

Specifications												
Catalog Number	V _{max} (Vdc)	I _{max} (A)	I _{hold} @ +23 °C (A)	I _{trip} @ +23 °C (A)	Pd Typ. (W)	Time to Trip (Max.)		Resistance (Ω)			Agency Information	
						(A)	(sec)	Initial (R _i)		Post Trip (R _t)	cURus	TUV
								Min.	Max.			
PTR016V0090	16	40	0.90	1.80	0.60	8.00	1.20	0.070	0.120	0.180		X
PTR016V0110	16	40	1.10	2.20	0.70	8.00	2.30	0.050	0.095	0.140		X
PTR016V0135	16	40	1.35	2.70	0.80	8.00	4.50	0.040	0.074	0.120		X
PTR016V0160	16	40	1.60	3.20	0.90	8.00	9.00	0.030	0.061	0.110		X
PTR016V0185	16	40	1.85	3.70	1.00	8.00	10.00	0.030	0.051	0.090		X
PTR016V0250	16	40	2.50	5.00	1.20	8.00	40.00	0.020	0.036	0.070		X
PTR016V0300	16	100	3.00	5.10	2.30	15.00	1.00	0.038	0.065	0.098	X	X
PTR016V0400	16	100	4.00	6.80	2.40	20.00	1.70	0.021	0.038	0.060	X	X
PTR016V0500	16	100	5.00	8.50	2.60	25.00	2.00	0.010	0.023	0.034	X	X
PTR016V0600	16	100	6.00	10.20	2.80	30.00	3.30	0.006	0.018	0.028	X	X
PTR016V0700	16	100	7.00	11.90	3.00	35.00	3.50	0.006	0.013	0.020	X	X
PTR016V0800	16	100	8.00	13.60	3.00	40.00	5.00	0.005	0.011	0.018	X	X
PTR016V0900	16	100	9.00	15.30	3.30	45.00	5.50	0.005	0.009	0.014	X	X
PTR016V1000	16	100	10.00	17.00	3.60	50.00	6.00	0.004	0.007	0.010	X	X
PTR016V1100	16	100	11.00	18.70	3.70	55.00	7.00	0.003	0.006	0.009	X	X
PTR016V1200	16	100	12.00	20.40	4.20	60.00	7.50	0.003	0.006	0.009	X	X
PTR016V1300	16	100	13.00	22.10	4.60	65.00	8.50	0.002	0.006	0.008	X	X
PTR016V1400	16	100	14.00	23.80	4.60	70.00	9.00	0.002	0.005	0.007	X	X
PTR016V1500	16	100	15.00	25.50	4.60	75.00	10.00	0.002	0.005	0.007	X	X

Notes: I_{hold} – Hold current: Maximum current device will pass without interruption in +23 °C still air.
 I_{trip} – Trip current: Minimum current that will switch the device from low resistance to high resistance in +23 °C still air.
 V_{max}: Maximum continuous voltage device can withstand without damage at rated current.
 I_{max}: Maximum fault current device can withstand without damage at rated voltage.
 Pd: Power dissipated from device when in the tripped state in +23 °C still air.
 R_i (min.): Minimum resistance of device as supplied at +23 °C unless otherwise specified.
 R_i (max.): Maximum resistance of device when measured one hour post reflow (SMD) or one hour post trip (radial-leaded device) at +23 °C unless otherwise specified.



Powering Business Worldwide

Dimensions - mm

Part Number	A Max.	B Max Lead Type		C	D Min.	E Max.	F	Figure/Lead Style	
		Straight (-TR)	Kink (-TR1)					Straight TR	Kink TR1
PTR016V0090	7.4	12.2	12.2	5.0±0.8	7.6	3.5	0.5±0.02	2	1
PTR016V0110	7.4	14.2	14.2	5.0±0.8	7.6	3.5	0.5±0.02	2	1
PTR016V0135	8.9	13.5	13.5	5.0±0.8	7.6	3.5	0.5±0.02	2	1
PTR016V0160	8.9	15.2	15.2	5.0±0.8	7.6	3.5	0.5±0.02	2	1
PTR016V0185	10.2	15.7	15.7	5.0±0.8	7.6	3.5	0.5±0.02	2	1
PTR016V0250	11.4	18.3	20.5	5.0±0.8	7.6	3.5	0.5±0.02	2	1
PTR016V0300	7.1	11.0	14.0	5.0±0.8	7.6	3.5	0.8±0.02	2	1
PTR016V0400	8.9	12.8	14.8	5.0±0.8	7.6	3.5	0.8±0.02	2	1
PTR016V0500	10.4	14.3	16.0	5.0±0.8	7.6	3.5	0.8±0.02	2	1
PTR016V0600	10.7	17.1	19.0	5.0±0.8	7.6	3.5	0.8±0.02	2	1
PTR016V0700	11.2	19.7	22.0	5.0±0.8	7.6	3.5	0.8±0.02	2	1
PTR016V0800	12.7	20.9	23.0	5.0±0.8	7.6	3.5	0.8±0.02	2	1
PTR016V0900	14.0	21.9	24.0	5.0±0.8	7.6	3.5	0.8±0.02	2	1
PTR016V1000	16.5	25.2	28.0	5.0±0.8	7.6	3.5	0.8±0.02	2	1
PTR016V1100	17.5	26.0	29.0	5.0±0.8	7.6	3.5	0.8±0.02	2	1
PTR016V1200	17.5	28.0	31.0	10.0±0.8	7.6	3.5	1.0±0.02	2	1
PTR016V1300	21.6	29.2	32.0	10.0±0.8	7.6	3.5	1.0±0.02	2	1
PTR016V1400	23.5	27.9	30.0	10.0±0.8	7.6	3.5	1.0±0.02	2	1
PTR016V1500	25.1	29.0	32.0	10.0±0.8	7.6	3.5	1.0±0.02	2	1

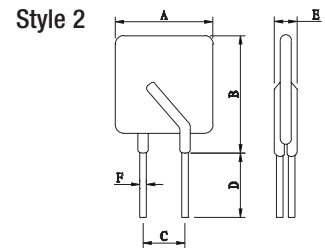
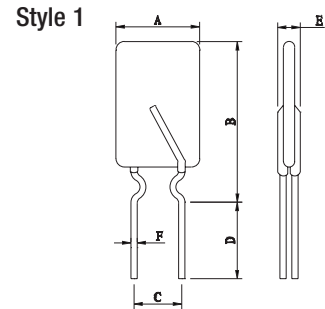

Packaging/Taping Specifications

Description	IEC Mark	Dimension (mm)	Tolerance (mm)
Sprocket hole pitch	P ₀	12.7	±0.3
Ordinate to adjacent component lead:			
PTR016V0090~PTR016V0250	P ₁	3.6	±1.0
PTR016V0300~PTR016V1100	P ₁	4.5	±1.0
PTR016V1200~PTR016V1500	P ₁	7.2	±1.0
Device pitch:			
PTR016V0090~PTR016V0600	P	12.7	±1.0
PTR016V0700~PTR016V1400	P	25.4	±1.0
PTR016V1500	P	38.1	±1.0
Lead spacing	C	*	--
Carrier tape width	W	18	±1.0
Top distance between tape edges	W ₀	3.0	Max.
Hold-down tape width	W ₁	12	±1.0
Sprocket hole position	W ₂	9.0	+0.75/-0.5
Abscissa to top:			
PTR016V0090~PTR016V0600	H ₁	32.2	Max.
PTR016V0700~PTR016V1500	H ₁	47.5	Max.
Abscissa to plane			
(straight lead)	H	18.0	+2/-0
(kinked lead)	H ₀	16.0	±0.5
Sprocket hole diameter	D ₀	4	±0.2
Lead protrusion	L ₁	1	Max.
Tape thickness	t	0.9	Max.
Body lateral deviation	Δ _h	0	±1.0
Body tape plane deviation	Δ _p	0	±1.3
Reel width	W ₃	56	Max.
Reel diameter		340	±10
Arbor hole diameter	n ₀	31	±1
Core diameter	n	80	Min.

* See Dimensions table.

Style 1 - PTR016V0090, PTR016V0110, PTR016V0135, PTR016V0160-PTR016V1000

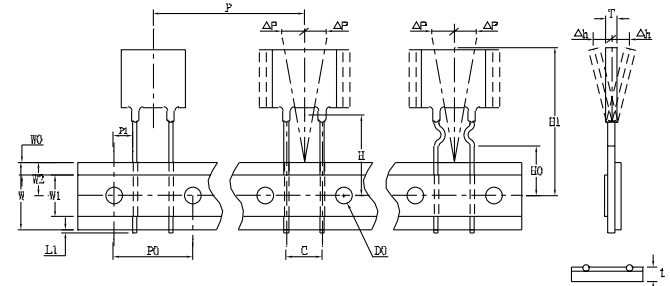

Style 2 - PTR016V1200-PTR016V1500

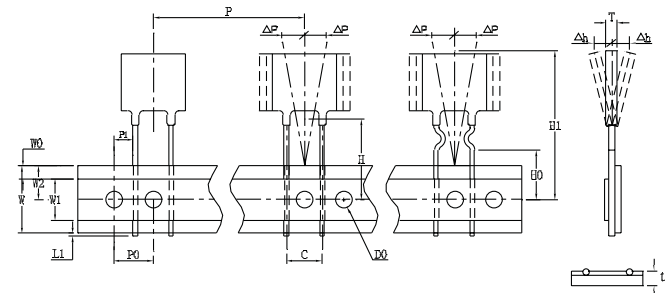

Reel Specifications

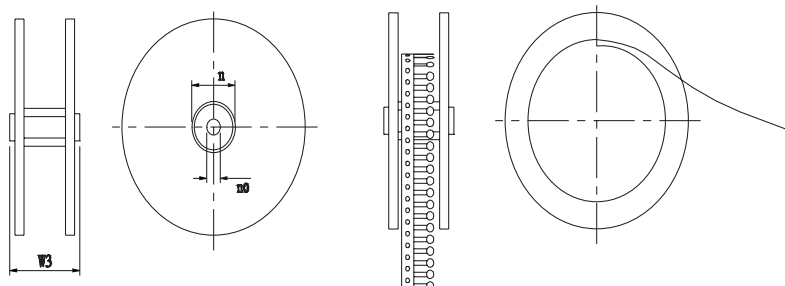

Time-to-Trip Curves at +23 °C - 0.9-2.5 A

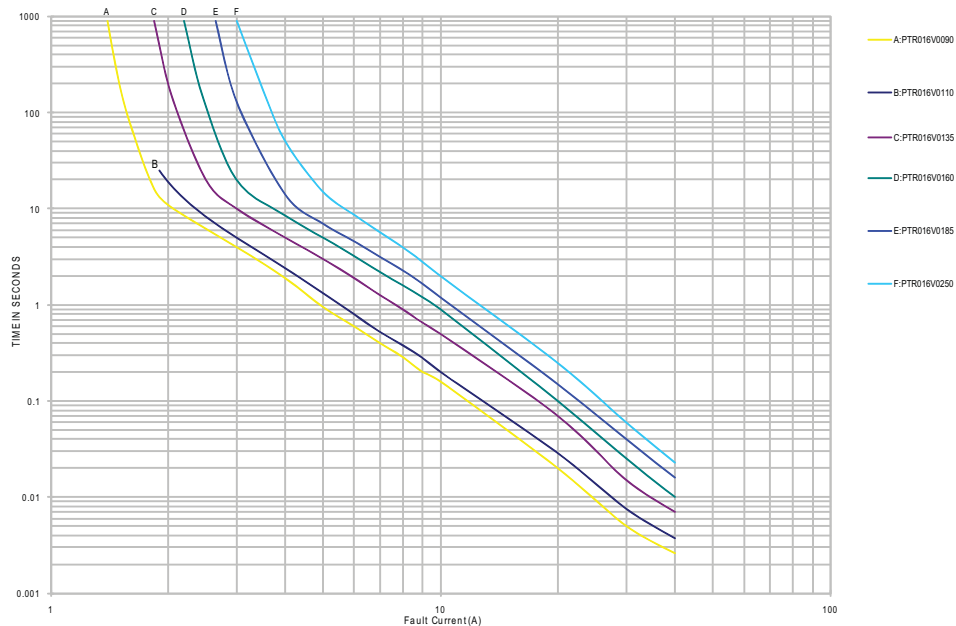

Time-to-Trip Curves at +23 °C - 3.0-15 A

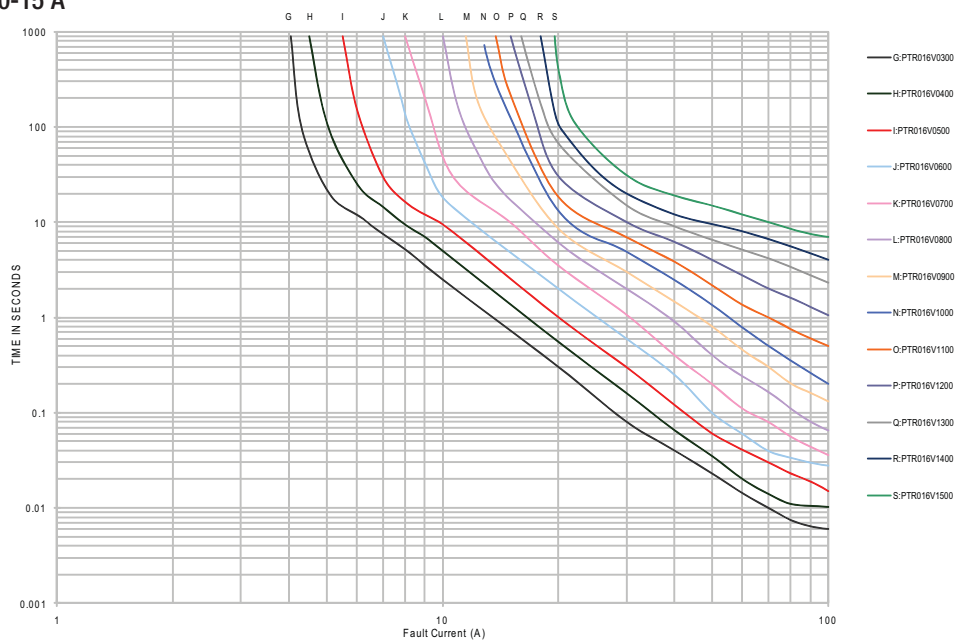

Thermal Derating Curve

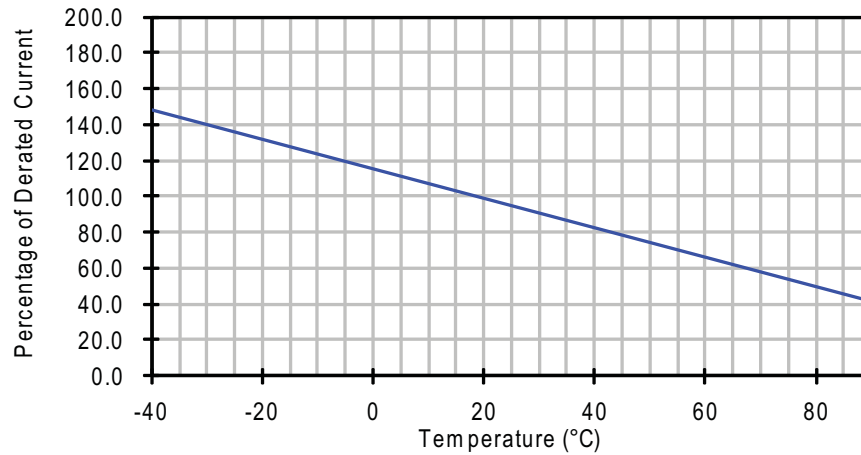

Recommended Wave Solder Profile

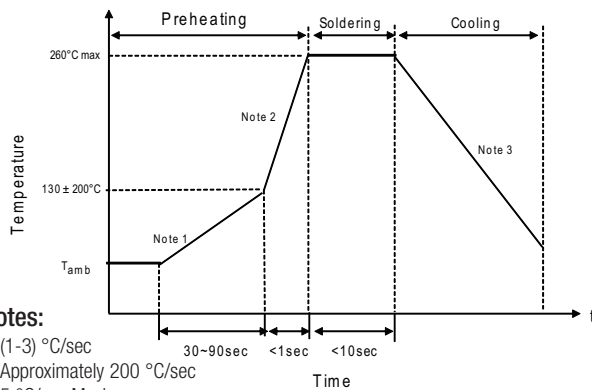

Notes:

1. (1-3) °C/sec
2. Approximately 200 °C/sec
3. 5 °C/sec Maximum

Recommended Reworking Conditions with Soldering Iron

- Soldering Iron Tip Temperature: +360 °C max.
- Solder Time: 3 seconds max.
- Distance from Thermistor: 2 mm min.

Environmental Specifications	
Characteristic	Value
Operating Temperature Range	-40 °C to +85 °C
Surface Temperature Trip State	+125 °C max.
Thermal Shock	+85 °C to -40 °C , 10 cycles, 5% typical resistance change
Solvent Resistance	MIL-STD-202 Method 215, no change
Humidity Age Test	+85 °C, 85% R.H., 1000 hours ±5% typical resistance change. Specified temperature (+23 °C ± 3 °C)
Storage Temperature Range	-10 °C to +40 °C
Storage Duration	One year
Storage Relative Humidity	≤75%
Storage Conditions	Keep away from corrosive atmosphere and sunlight

Material Composition

- Lead material:
 - PTR016V0090-PTR016V0250 Tin-plated copper clad steel
 - PTR016V0300-PTR016V1500 Tin-plated copper
- Insulating material: Cured epoxy resin meeting UL 94V0 requirements

Life Support Policy: Eaton does not authorize the use of any of its products for use in life support devices or systems without the express written approval of an officer of the Company. Life support systems are devices which support or sustain life, and whose failure to perform, when properly used in accordance with instructions for use provided in the labeling, can be reasonably expected to result in significant injury to the user.

Eaton reserves the right, without notice, to change design or construction of any products and to discontinue or limit distribution of any products. Eaton also reserves the right to change or update, without notice, any technical information contained in this bulletin.

Eaton
Electronics Division
 1000 Eaton Boulevard
 Cleveland, OH 44122
 United States
www.eaton.com/electronics

© 2017 Eaton
 All Rights Reserved
 Printed in USA
 Publication No. 4399 BU-SB111164
 October 2017