

FIRST CIRCUIT MARK
(NOT SHOWING ON 2
AND 3 CIRCUITS SERIES)

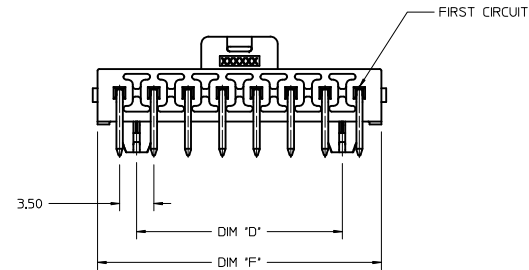

NOTES:

- MATERIAL :
HOUSING
OPTION 1: LCP E130i BLACK
OPTION 2: LCP E130i NATURAL
TERMINAL: COPPER ALLOY
- PLATING FINISH:
OPTION 1 - 1.5µm(60µin)-2.5µm(100µin) TIN OVER
1.25µm(50µin)-2.5µm(100µin) NICKEL OVERALL
OPTION 2 - 0.35µm(15µin) GOLD CONTACT AREA,
1.5µm(60µin)-2.5µm(100µin) TIN TAIL AREA OVER
1.25µm(50µin)-2.5µm(100µin) NICKEL OVERALL
OPTION 3 - 0.70µm(30µin) GOLD CONTACT AREA,
1.5µm(60µin)-2.5µm(100µin) TIN TAIL AREA OVER
1.25µm(50µin)-2.5µm(100µin) NICKEL OVERALL
- PARTS TO BE PACKAGED PER PK-172310-9001
- PRODUCT SPECIFICATION PS-172323-0001
- PART MATES WITH MOLEX RECEPTACLE HOUSING
172256 AND 172260
- PART CONFORMS TO CLASS 'C' REQUIREMENTS OF SPECIFICATION
PS-45499-002 WITH 0.13 MM MAXIMUM FLASH ALLOWED IN CORE
HOLES AND FRONT SURFACE.
- DISCOLORATION IN THE BANDOLIER AREA OF THE PIN IS
INHERENT TO THE PLATING PROCESS AND IS DUE TO THE MASKING
EFFECT OF THE CARRIER. THIS DISCOLORATION IS IN A NON-FUNCTIONAL
AREA OF THE PIN AND WILL NOT AFFECT THE PERFORMANCE OF THE
HEADER ASSEMBLY.
- ASSEMBLY SPECIFICATION: AS-172323-0001

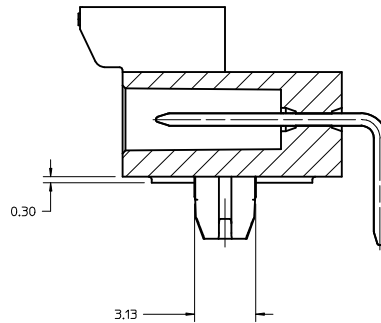
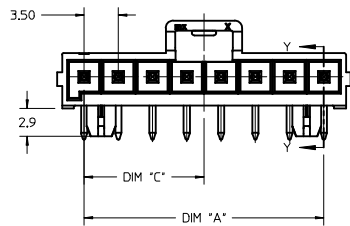
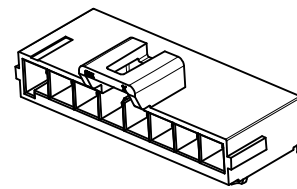
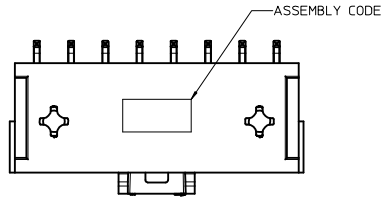
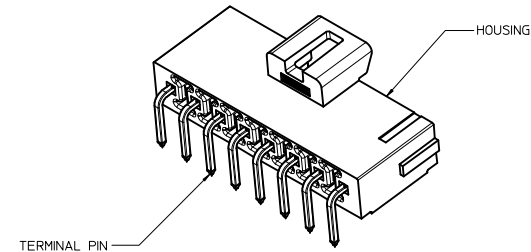
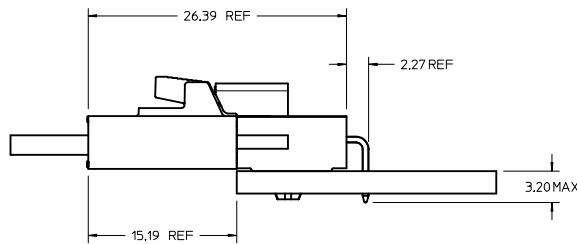

X RELEASE IEC NO: LCP2015-4103 DRAWN: DROSCA CHYK: APPR: RHODGE 2015/04/13 2015/04/15	QUALITY SYMBOLS	GENERAL TOLERANCES (UNLESS SPECIFIED)	DIMENSION STYLE	SCALE	DESIGN UNITS	THIRD ANGLE PROJECTION
	▽=0	mm INCH	MM ONLY	4:1	METRIC	☉
	▽=0	4 PLACES ± ---	DRAWN BY DATE			TITLE
	▽=0	3 PLACES ± ---	DROSCA 2014/03/05			ULTRA-FIT R/A HEADER 2-8 CKTS SINGLE ROW
		2 PLACES ± 0.25	CHECKED BY DATE			
		1 PLACE ± 0.50	APPROVED BY DATE			
		0 PLACE ± ---	JCOMERCI 2014/04/24			
		ANGULAR ±1/2°	MATERIAL NO.			
		DRAFT WHERE APPLICABLE MUST REMAIN WITHIN DIMENSIONS	SEE CHART		DOCUMENT NO.	
			SIZE D		SD-172310-1000	
						SHEET NO. 1 OF 3

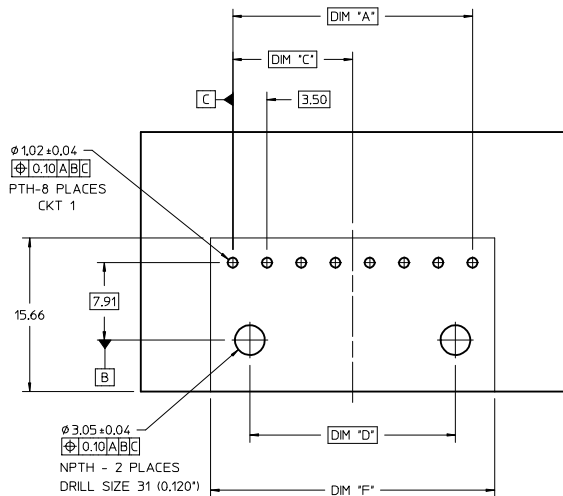

PCB LAYOUT 4,5,6,7 AND 8 COMPONENT SIDE
RECOMMENDED PCB THICKNESS 1.60MM-2.40MM

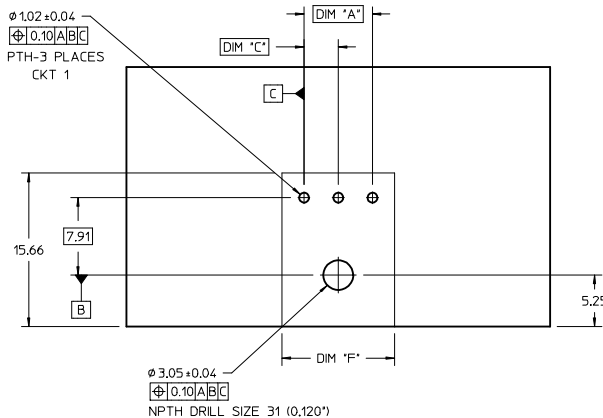

PCB LAYOUT 3 CIRCUIT COMPONENT SIDE
RECOMMENDED PCB THICKNESS 1.60MM-2.40MM

TIN PLATING							
PART NO.	COLOR	CIRCUIT SIZE	KEY OPTION	DIM A	DIM F	DIM C	DIM D
172310-1102	BLACK	2	KEY A	3.50	8.00	1.75	0.00
172310-1103	BLACK	3	KEY A	7.00	11.50	3.50	0.00
172310-1104	BLACK	4	KEY A	10.50	15.00	5.25	7.00
172310-1105	BLACK	5	KEY A	14.00	18.50	7.00	10.50
172310-1106	BLACK	6	KEY A	17.50	22.00	8.75	14.00
172310-1107	BLACK	7	KEY A	21.00	25.50	10.50	17.50
172310-1108	BLACK	8	KEY A	24.50	29.00	12.25	21.00
172310-2102	NATURAL	2	KEY B	3.50	8.00	1.75	0.00
172310-2103	NATURAL	3	KEY B	7.00	11.50	3.50	0.00
172310-2104	NATURAL	4	KEY B	10.50	15.00	5.25	7.00
172310-2105	NATURAL	5	KEY B	14.00	18.50	7.00	10.50
172310-2106	NATURAL	6	KEY B	17.50	22.00	8.75	14.00
172310-2107	NATURAL	7	KEY B	21.00	25.50	10.50	17.50
172310-2108	NATURAL	8	KEY B	24.50	29.00	12.25	21.00

15 MICROINCH GOLD PLATING							
PART NO.	COLOR	CIRCUIT SIZE	KEY OPTION	DIM A	DIM F	DIM C	DIM D
172310-1202	BLACK	2	KEY A	3.50	8.00	1.75	0.00
172310-1203	BLACK	3	KEY A	7.00	11.50	3.50	0.00
172310-1204	BLACK	4	KEY A	10.50	15.00	5.25	7.00
172310-1205	BLACK	5	KEY A	14.00	18.50	7.00	10.50
172310-1206	BLACK	6	KEY A	17.50	22.00	8.75	14.00
172310-1207	BLACK	7	KEY A	21.00	25.50	10.50	17.50
172310-1208	BLACK	8	KEY A	24.50	29.00	12.25	21.00
172310-2202	NATURAL	2	KEY B	3.50	8.00	1.75	0.00
172310-2203	NATURAL	3	KEY B	7.00	11.50	3.50	0.00
172310-2204	NATURAL	4	KEY B	10.50	15.00	5.25	7.00
172310-2205	NATURAL	5	KEY B	14.00	18.50	7.00	10.50
172310-2206	NATURAL	6	KEY B	17.50	22.00	8.75	14.00
172310-2207	NATURAL	7	KEY B	21.00	25.50	10.50	17.50
172310-2208	NATURAL	8	KEY B	24.50	29.00	12.25	21.00

30 MICROINCH GOLD PLATING							
PART NO.	COLOR	CIRCUIT SIZE	KEY OPTION	DIM A	DIM F	DIM C	DIM D
172310-1302	BLACK	2	KEY A	3.50	8.00	1.75	0.00
172310-1303	BLACK	3	KEY A	7.00	11.50	3.50	0.00
172310-1304	BLACK	4	KEY A	10.50	15.00	5.25	7.00
172310-1305	BLACK	5	KEY A	14.00	18.50	7.00	10.50
172310-1306	BLACK	6	KEY A	17.50	22.00	8.75	14.00
172310-1307	BLACK	7	KEY A	21.00	25.50	10.50	17.50
172310-1308	BLACK	8	KEY A	24.50	29.00	12.25	21.00
172310-2302	NATURAL	2	KEY B	3.50	8.00	1.75	0.00
172310-2303	NATURAL	3	KEY B	7.00	11.50	3.50	0.00
172310-2304	NATURAL	4	KEY B	10.50	15.00	5.25	7.00
172310-2305	NATURAL	5	KEY B	14.00	18.50	7.00	10.50
172310-2306	NATURAL	6	KEY B	17.50	22.00	8.75	14.00
172310-2307	NATURAL	7	KEY B	21.00	25.50	10.50	17.50
172310-2308	NATURAL	8	KEY B	24.50	29.00	12.25	21.00

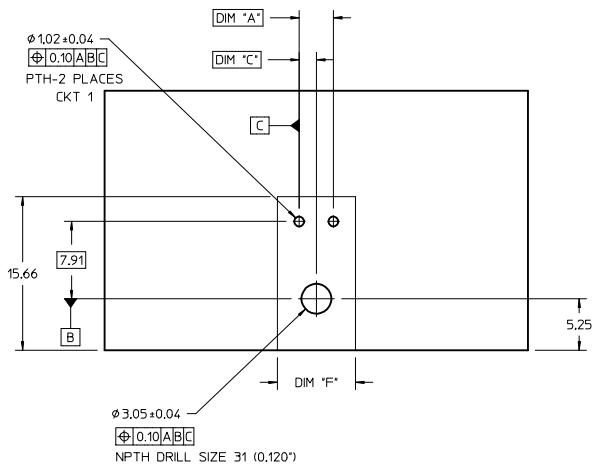

PCB LAYOUT 2 CIRCUIT COMPONENT SIDE
RECOMMENDED PCB THICKNESS 1.60MM-2.40MM

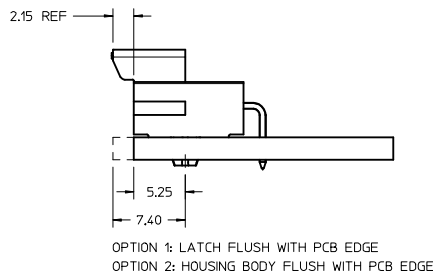

OPTION 1: LATCH FLUSH WITH PCB EDGE
OPTION 2: HOUSING BODY FLUSH WITH PCB EDGE

NOTE: DATUM -A- IS ON PCB COMPONENT SIDE

SEE PAGE 1 IEC NO: UCP2015-4103 DRAWN: DROSCA CHKD: APPR: RHODGE DATE: 2015/04/13 DATE: 2015/04/15	QUALITY SYMBOLS	GENERAL TOLERANCES (UNLESS SPECIFIED)	DIMENSION STYLE	SCALE	DESIGN UNITS	THIRD ANGLE PROJECTION	
	$\nabla=0$ $\nabla=0$ $\nabla=0$	mm INCH 4 PLACES ± --- ± --- 3 PLACES ± --- ± --- 2 PLACES ± 0.25 ± --- 1 PLACE ± 0.50 ± --- 0 PLACE ± --- ± ---	MM ONLY	4:1	METRIC	DRAWN BY: DROSCA DATE: 2014/03/05 CHECKED BY: DATE APPROVED BY: JCOMERCI DATE: 2014/04/24	TITLE: ULTRA-FIT R/A HEADER 2-8 CKTS SINGLE ROW molex DOCUMENT NO: SD-172310-1000
	ANGULAR ±1/2° DRAFT WHERE APPLICABLE MUST REMAIN WITHIN DIMENSIONS	MATERIAL NO: SEE PAGE 1 SIZE D	SHEET NO: 2 OF 3				
	THIS DRAWING CONTAINS INFORMATION THAT IS PROPRIETARY TO MOLEX INCORPORATED AND SHOULD NOT BE USED WITHOUT WRITTEN PERMISSION						

20 19 18 17 16 15 14 13 12 11 10 9 8 7 6 5 4 3 2 1

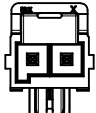

2 CKT

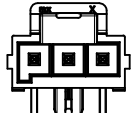

3 CKT

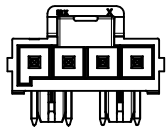

4 CKT

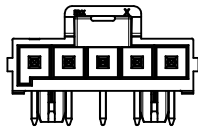

5 CKT

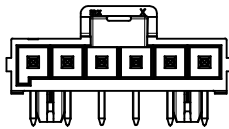

6 CKT

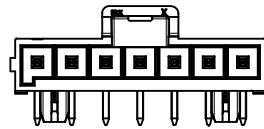

7 CKT

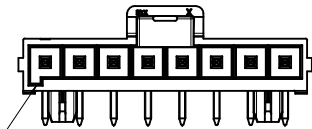

8 CKT

KEY A
(BLACK)

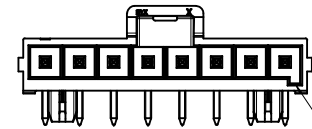

KEY B
(NATURAL)

SEE PAGE 1 IEC NO: UCF2015-4103 DRAWN: DROSCA 2015/04/13 CHKD: APPR: RHODGE 2015/04/15 REVISIONS 1 DESCRIPTION	QUALITY SYMBOLS	GENERAL TOLERANCES (UNLESS SPECIFIED)	DIMENSION STYLE	SCALE	DESIGN UNITS	THIRD ANGLE PROJECTION
	$\nabla=0$ $\nabla=0$ $\nabla=0$	4 PLACES ± --- ± --- 3 PLACES ± --- ± --- 2 PLACES ± 0.25 ± --- 1 PLACE ± 0.50 ± --- 0 PLACE ± --- ± ---	mm INCH ANGULAR ±1/2° DRAFT WHERE APPLICABLE MUST REMAIN WITHIN DIMENSIONS	MM ONLY DRAWN BY: DROSCA DATE: 2014/03/05 CHECKED BY: DATE: APPROVED BY: JCOMERCI DATE: 2014/04/24	4:1	METRIC
MATERIAL NO: SIZE: D	SEE PAGE 1	SHEET NO: 3 OF 3	THIS DRAWING CONTAINS INFORMATION THAT IS PROPRIETARY TO MOLEX INCORPORATED AND SHOULD NOT BE USED WITHOUT WRITTEN PERMISSION			

19 18 17 16 15 14 13 12 11 10 9 8 7 6 5 4 3 2 1