



High-Output-Drive, Precision, Low-Power, Single-Supply, Rail-to-Rail I/O Op Amps with Shutdown

General Description

The MAX4165–MAX4169 family of operational amplifiers combines excellent DC accuracy with high output current drive, single-supply operation, and rail-to-rail inputs and outputs. These devices operate from a single +2.7V to +6.5V supply, or from dual $\pm 1.35V$ to $\pm 3.25V$ supplies. They typically draw 1.2mA supply current, and are guaranteed to deliver 80mA output current.

The MAX4166/MAX4168 have a shutdown mode that reduces supply current to 38 μA per amplifier and places the outputs into a high-impedance state. The MAX4165–MAX4169's precision performance combined with high output current, wide input/output dynamic range, single-supply operation, and low power consumption makes them ideal for portable audio applications and other low-voltage, battery-powered systems. The MAX4165 is available in the space-saving 5-pin SOT23 package and the MAX4166 is available in a tiny 2mm x 2mm x 0.8mm μDFN package.

Selector Guide

PART	AMPS PER PACKAGE	SHUTDOWN MODE
MAX4165	Single	—
MAX4166	Single	Yes
MAX4167	Dual	—
MAX4168	Dual	Yes
MAX4169	Quad	—

Applications

Portable/Battery-Powered Audio Applications
 Portable Headphone Speaker Drivers
 Laptop/Notebook Computers
 Sound Ports/Cards
 Set-Top Boxes
 Cell Phones
 Hands-Free Car Phones (kits)
 Signal Conditioning
 Digital-to-Analog Converter Buffers
 Transformer/Line Drivers
 Motor Drivers

Typical Operating Circuit appears at end of data sheet.

Features

- ◆ 80mA (min) Output Drive Capability
- ◆ Rail-to-Rail Input Common-Mode Voltage Range
- ◆ Rail-to-Rail Output Voltage Swing
- ◆ 1.2mA Supply Current per Amplifier
- ◆ +2.7V to +6.5V Single-Supply Operation
- ◆ 5MHz Gain-Bandwidth Product
- ◆ 250 μV Offset Voltage
- ◆ 120dB Voltage Gain ($R_L = 100k\Omega$)
- ◆ 88dB Power-Supply Rejection Ratio
- ◆ No Phase Reversal for Overdriven Inputs
- ◆ Unity-Gain Stable for Capacitive Loads to 250pF
- ◆ Low-Power Shutdown Mode:
 Reduces Supply Current to 38 μA Places Outputs in High-Impedance State
- ◆ Available in 5-Pin SOT23 Package (MAX4165) or 2mm x 2mm x 0.8mm μDFN (MAX4166)

Ordering Information

PART	TEMP RANGE	PIN-PACKAGE	TOP MARK
MAX4165EUK-T	-40°C to +85°C	5 SOT23-5	AABY
MAX4166EPA	-40°C to +85°C	8 Plastic DIP	—
MAX4166ESA	-40°C to +85°C	8 SO	—
MAX4166EUA	-40°C to +85°C	8 μMAX	—
MAX4166ELA+T	-40°C to +85°C	8 μDFN -8	AAG

+ Denotes lead-free package.

Ordering Information continued on last page.

Pin Configurations

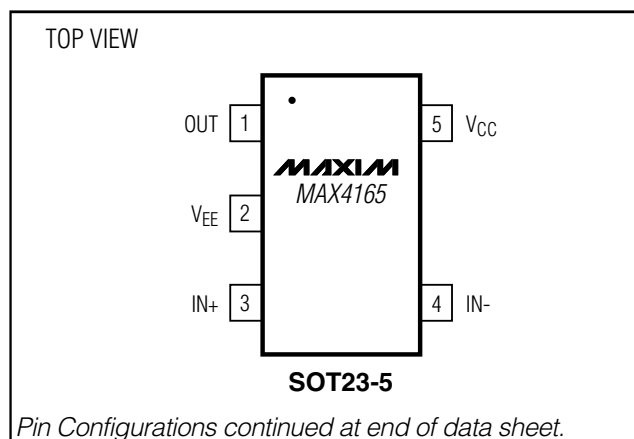

High-Output-Drive, Precision, Low-Power, Single-Supply, Rail-to-Rail I/O Op Amps with Shutdown

ABSOLUTE MAXIMUM RATINGS

Supply Voltage (V_{CC} to V_{EE})	7V	8-Pin μ DFN (derate 4.8mW/°C above +70°C)	380mW
IN_+ , IN_- , \overline{SHDN}	$(V_{EE} - 0.3V) + (V_{CC} + 0.3V)$	10-Pin μ MAX (derate 5.60mW/°C above +70°C)	444mW
OUT_+ (shutdown mode)	$(V_{EE} - 0.3V) + (V_{CC} + 0.3V)$	14-Pin Plastic DIP (derate 10.00mW/°C above +70°C)	800mW
Output Short-Circuit Duration to V_{CC} or V_{EE} (Note 1)	Continuous	14-Pin SO (derate 8.33mW/°C above +70°C)	667mW
Continuous Power Dissipation ($T_A = +70^\circ\text{C}$)		Operating Temperature Range	-40°C to +85°C
5-Pin SOT23 (derate 7.10mW/°C above +70°C)	571mW	Junction Temperature	+150°C
8-Pin Plastic DIP (derate 9.09mW/°C above +70°C)	727mW	Storage Temperature Range	-65°C to +150°C
8-Pin SO (derate 5.88mW/°C above +70°C)	471mW	Lead Temperature (soldering, 10s)	+300°C
8-Pin μ MAX (derate 4.10mW/°C above +70°C)	330mW		

Note 1: Continuous power dissipation should also be observed.

Stresses beyond those listed under "Absolute Maximum Ratings" may cause permanent damage to the device. These are stress ratings only, and functional operation of the device at these or any other conditions beyond those indicated in the operational sections of the specifications is not implied. Exposure to absolute maximum rating conditions for extended periods may affect device reliability.

DC ELECTRICAL CHARACTERISTICS

($V_{CC} = +2.7V$ to $+6.5V$, $V_{EE} = 0V$, $V_{CM} = 0V$, $V_{OUT} = (V_{CC} / 2)$, $R_L = 100k\Omega$ to $(V_{CC} / 2)$, $V_{\overline{SHDN}} \geq 2V$, $T_A = +25^\circ\text{C}$, unless otherwise noted.)

PARAMETER	SYMBOL	CONDITIONS		MIN	TYP	MAX	UNITS
Input Offset Voltage	V_{OS}	$V_{CM} = V_{EE}$ to V_{CC}	MAX416_EPA/EPD	0.25	0.85	mV	
			MAX416_ESA/ESD	0.25	0.85		
			MAX416_EUA/EUB/ELA	0.35	1.7		
			MAX416_EUK	0.35	1.5		
			MAX4169E_D	0.25	1.0		
Input Bias Current	I_B	$V_{CM} = V_{EE}$ to V_{CC}	± 50	± 150	nA		
Input Offset Current	I_{OS}	$V_{CM} = V_{EE}$ to V_{CC}	± 1	± 15	nA		
Differential Input Resistance	$R_{IN(DIFF)}$	$ V_{IN+} - V_{IN-} \leq 1.8V$	500		k Ω		
		$ V_{IN+} - V_{IN-} > 1.8V$	2				
Common-Mode Input Voltage Range	V_{CM}	Inferred from CMRR test	$V_{EE} - 0.25$	$V_{CC} + 0.25$	V		
Common-Mode Rejection Ratio	CMRR	$V_{EE} - 0.25V < V_{CM} < (V_{CC} + 0.25V)$	MAX416_EPA/EPD	72	93	dB	
			MAX416_ESA/ESD	72	93		
			MAX416_EUA/EUB/ELA	62	89		
			MAX416_EUK	63	90		
			MAX4169E_D	71	93		
Power-Supply Rejection Ratio	PSRR	$V_{CC} = 2.7V$ to $6.5V$	MAX416_EPA/EPD	72	88	dB	
			MAX416_ESA/ESD	72	88		
			MAX416_EUA/EUB/ELA	72	86		
			MAX416_EUK	72	86		
			MAX4169E_D	70	88		
Output Resistance	R_{OUT}	$A_{VCL} = +1V/V$	0.1		k Ω		
Off-Leakage Current in Shutdown	$I_{OUT(\overline{SHDN})}$	$V_{\overline{SHDN}} < 0.8V$, $V_{OUT} = 0V$ to V_{CC}	± 0.001	± 2	μA		
Large-Signal Voltage Gain	A_{VOL}	$V_{CC} = 5V$	$V_{OUT} = 0.2V$ to $4.8V$, $R_L = 100k\Omega$	95	120	dB	
			$V_{OUT} = 0.6V$ to $4.4V$, $R_L = 25\Omega$	71	83		

High-Output-Drive, Precision, Low-Power, Single-Supply, Rail-to-Rail I/O Op Amps with Shutdown

MAX4165-MAX4169

DC ELECTRICAL CHARACTERISTICS (continued)

($V_{CC} = +2.7V$ to $+6.5V$, $V_{EE} = 0V$, $V_{CM} = 0V$, $V_{OUT} = (V_{CC} / 2)$, $R_L = 100k\Omega$ to $(V_{CC} / 2)$, $V_{SHDN} \geq 2V$, $T_A = +25^\circ C$, unless otherwise noted.)

PARAMETER	SYMBOL	CONDITIONS		MIN	TYP	MAX	UNITS
Output Voltage Swing	V_{OUT}	$V_{CC} = 5V$	$R_L = 100k\Omega$	$V_{CC} - V_{OH}$	15	30	mV
				$V_{OL} - V_{EE}$	10	25	
			$R_L = 25\Omega$	$V_{CC} - V_{OH}$	340	430	
				$V_{OL} - V_{EE}$	160	350	
Output Source/Sink Current (Note 2)		$V_{OUT} = 0.6V$ to $(V_{CC} - 0.6V)$		± 80	± 125		mA
\overline{SHDN} Logic Threshold (Note 3)	V_{IL}	Shutdown mode				0.8	V
	V_{IH}	Normal mode		2.0			
\overline{SHDN} Input Bias Current		$V_{EE} < V_{SHDN} < V_{CC}$				± 3.0	μA
Operating Supply-Voltage Range	V_{CC}	Inferred from PSRR test		2.7		6.5	V
Quiescent Supply Current (per Amplifier)	I_{CC}	$V_{CC} = 5V$			1.3	1.5	mA
		$V_{CC} = 3V$			1.2	1.4	
Shutdown Supply Current (per Amplifier)	$I_{CC}(\overline{SHDN})$	$V_{SHDN} < 0.8V$	$V_{CC} = 5V$		58	75	μA
			$V_{CC} = 3V$		38	49	

DC ELECTRICAL CHARACTERISTICS

($V_{CC} = +2.7V$ to $+6.5V$, $V_{EE} = 0V$, $V_{CM} = 0V$, $V_{OUT} = (V_{CC} / 2)$, $R_L = 100k\Omega$ to $(V_{CC} / 2)$, $V_{SHDN} \geq 2V$, $T_A = -40^\circ C$ to $+85^\circ C$, unless otherwise noted.) (Note 4)

PARAMETER	SYMBOL	CONDITIONS		MIN	TYP	MAX	UNITS
Input Offset Voltage	V_{OS}	$V_{CM} = V_{EE}$ to V_{CC}	MAX416_EPA/EPD			1.0	mV
			MAX416_ESA/ESD			1.0	
			MAX416_EUA/EUB/ELA			4.9	
			MAX416_EUK			4.3	
			MAX4169E_D			1.2	
Offset-Voltage Tempco	$\Delta V_{OS}/\Delta T$				± 3		$\mu V/^\circ C$
Input Bias Current	I_B	$V_{CM} = V_{EE}$ to V_{CC}				± 225	nA
Input Offset Current	I_{OS}	$V_{CM} = V_{EE}$ to V_{CC}				± 21	nA
Common-Mode Input Voltage Range	V_{CM}	Inferred from CMRR test		$V_{EE} - 0.15$		$V_{CC} + 0.15$	V
Common-Mode Rejection Ratio	CMRR	$V_{EE} - 0.15V < V_{CM} < (V_{CC} + 0.15V)$	MAX416_EPA/EPD			71	dB
			MAX416_ESA/ESD			71	
			MAX416_EUA/EUB/ELA			56	
			MAX416_EUK			57	
			MAX4169E_D			69	
Power-Supply Rejection Ratio	PSRR	$V_{CC} = 2.7V$ to $6.5V$	MAX416_EPA/EPD			67	dB
			MAX416_ESA/ESD			67	
			MAX416_EUA/EUB/ELA			65	
			MAX416_EUK			65	
			MAX4169E_D			66	

High-Output-Drive, Precision, Low-Power, Single-Supply, Rail-to-Rail I/O Op Amps with Shutdown

DC ELECTRICAL CHARACTERISTICS (continued)

($V_{CC} = +2.7V$ to $+6.5V$, $V_{EE} = 0V$, $V_{CM} = 0V$, $V_{OUT} = (V_{CC} / 2)$, $R_L = 100k\Omega$ to $(V_{CC} / 2)$, $V_{SHDN} \geq 2V$, $T_A = -40^\circ C$ to $+85^\circ C$, unless otherwise noted.)

PARAMETER	SYMBOL	CONDITIONS	MIN	TYP	MAX	UNITS
Off-Leakage Current in Shutdown	$I_{OUT(SHDN)}$	$V_{SHDN} < 0.8V$, $V_{OUT} = 0V$ to V_{CC}			± 5	μA
Large-Signal Voltage Gain	A_{VOL}	$V_{CC} = 5V$	$V_{OUT} = 0.2V$ to $4.8V$, $R_L = 100k\Omega$	90		dB
			$V_{OUT} = 0.6V$ to $4.4V$, $R_L = 25\Omega$	66		
Output Voltage Swing	V_{OUT}	$V_{CC} = 5V$	$R_L = 100k\Omega$	$V_{CC} - V_{OH}$	40	mV
				$V_{OL} - V_{EE}$	30	
			$R_L = 25\Omega$	$V_{CC} - V_{OH}$	490	
				$V_{OL} - V_{EE}$	400	
Output Source/Sink Current (Note 2)		$V_{OUT} = 0.6V$ to $(V_{CC} - 0.6V)$	± 80			mA
SHDN Logic Threshold (Note 3)	V_{IL}	Shutdown mode			0.8	V
	V_{IH}	Normal mode	2.0			
SHDN Input Bias Current		$V_{EE} < V_{SHDN} < V_{CC}$			± 3.5	μA
Operating Supply-Voltage Range	V_{CC}	Inferred from PSRR test	2.7		6.5	V
Quiescent Supply Current (per Amplifier)	I_{CC}	$V_{CC} = 5V$			1.7	mA
		$V_{CC} = 3V$			1.6	
Shutdown Supply Current (per Amplifier)	$I_{CC(SHDN)}$	$V_{SHDN} < 0.8V$	$V_{CC} = 5V$		82	μA
			$V_{CC} = 3V$		54	

Note 2: Although the minimum output current is guaranteed to be $\pm 80mA$, exercise caution to ensure that the absolute maximum power-dissipation rating of the package is not exceeded.

Note 3: SHDN logic thresholds are referenced to V_{EE} .

Note 4: The MAX4165EUK is 100% tested at $+25^\circ C$. All temperature limits are guaranteed by design.

AC ELECTRICAL CHARACTERISTICS

($V_{CC} = +2.7V$ to $+6.5V$, $V_{EE} = 0V$, $V_{CM} = 0V$, $V_{OUT} = (V_{CC} / 2)$, $R_L = 2.5k\Omega$ to $(V_{CC} / 2)$, $V_{SHDN} \geq 2V$, $C_L = 15pF$, $T_A = +25^\circ C$, unless otherwise noted.)

PARAMETER	SYMBOL	CONDITIONS	MIN	TYP	MAX	UNITS
Gain-Bandwidth Product	GBWP			5		MHz
Full-Power Bandwidth	FPBW	$V_{OUT} = 4V_{p-p}$, $V_{CC} = 5V$		260		kHz
Slew Rate	SR			2		V/ μs
Phase Margin	PM			68		degrees
Gain Margin	GM			21		dB
Total Harmonic Distortion	THD	$f = 10kHz$, $V_{OUT} = 2V_{p-p}$, $A_{VCL} = +1V/V$		0.005		%
Settling Time to 0.01%	t_S	$A_{VCL} = +1V/V$, 2V step		2.1		μs
Input Capacitance	C_{IN}			3		pF
Input Voltage-Noise Density	e_n	$f = 1kHz$		26		nV/\sqrt{Hz}
Input Current-Noise Density	i_n	$f = 1kHz$		0.4		pA/\sqrt{Hz}
Channel-to-Channel Isolation		$f = 1kHz$, $R_L = 100k\Omega$ (MAX4167-MAX4169)		125		dB
Capacitive Load Stability		$A_{VCL} = +1V/V$, no sustained oscillations		250		pF
Shutdown Time	t_{SHDN}			1		μs
Enable Time from Shutdown	t_{ENABLE}			1		μs
Power-Up Time	t_{ON}			5		μs

High-Output-Drive, Precision, Low-Power, Single-Supply, Rail-to-Rail I/O Op Amps with Shutdown

Typical Operating Characteristics

($V_{CC} = +5.0V$, $V_{EE} = 0V$, $R_L = 100k\Omega$, $T_A = +25^\circ C$, unless otherwise noted.)

MAX4165-MAX4169



High-Output-Drive, Precision, Low-Power, Single-Supply, Rail-to-Rail I/O Op Amps with Shutdown

Typical Operating Characteristics (continued)

($V_{CC} = +5.0V$, $V_{EE} = 0V$, $R_L = 100k\Omega$, $T_A = +25^\circ C$, unless otherwise noted.)

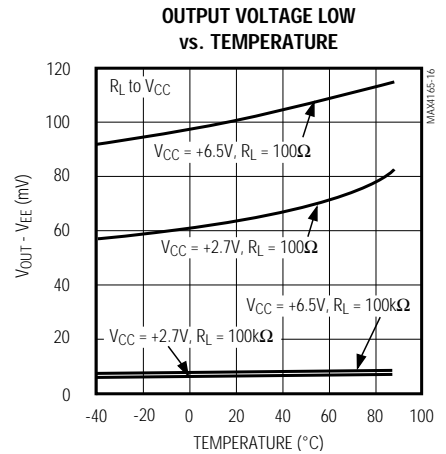
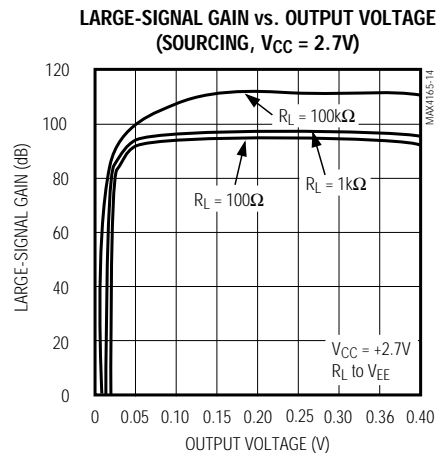
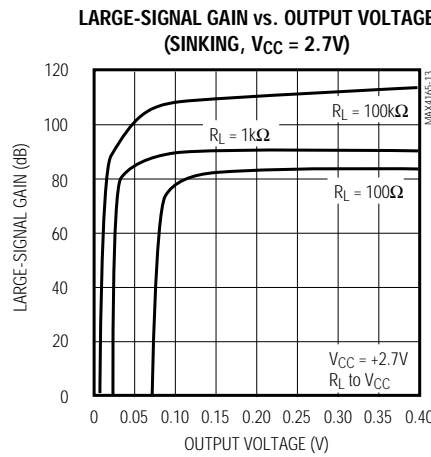
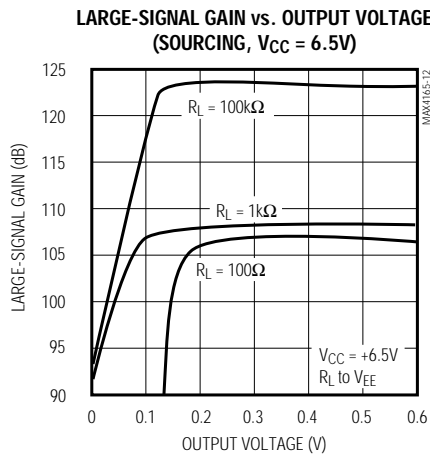
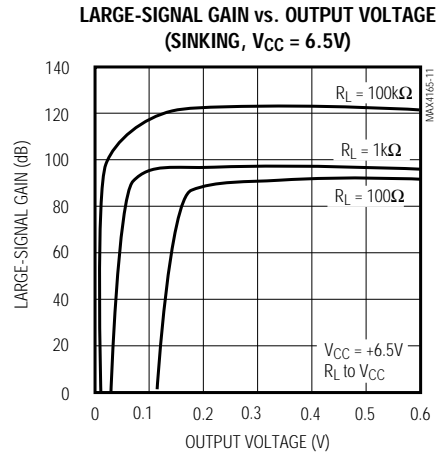
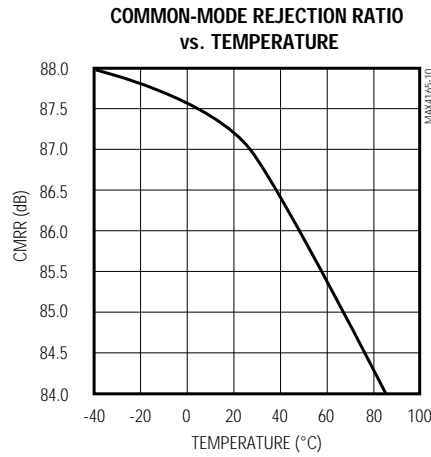
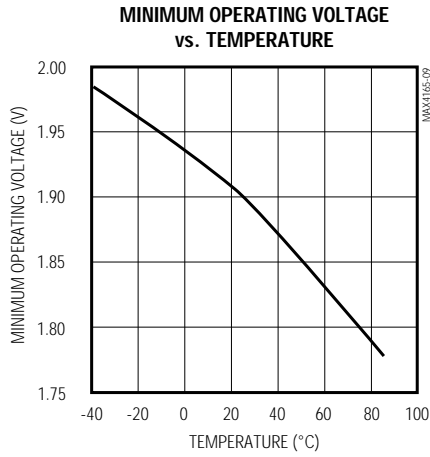

High-Output-Drive, Precision, Low-Power, Single-Supply, Rail-to-Rail I/O Op Amps with Shutdown

Typical Operating Characteristics (continued)

($V_{CC} = +5.0V$, $V_{EE} = 0V$, $R_L = 100k\Omega$, $T_A = +25^\circ C$, unless otherwise noted.)

MAX4165-MAX4169

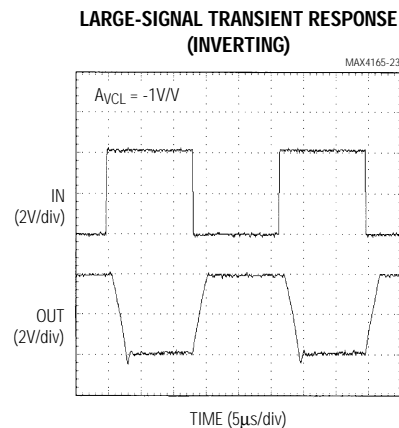
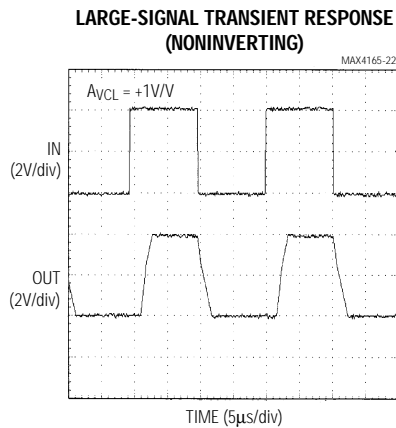
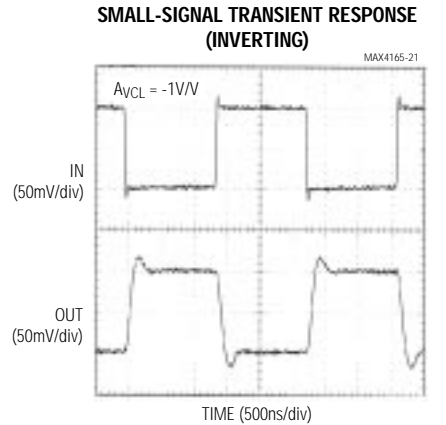
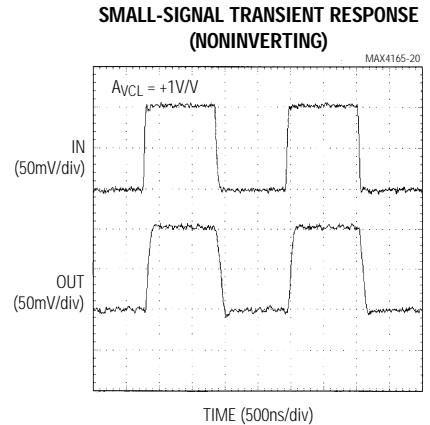
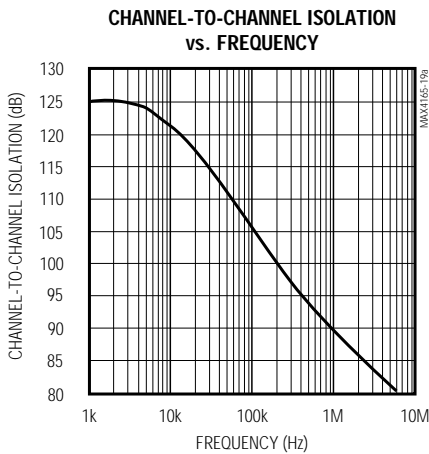
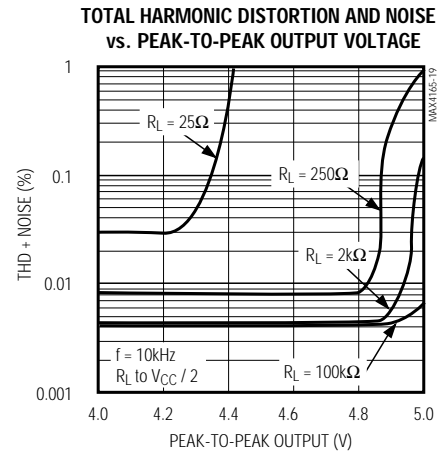
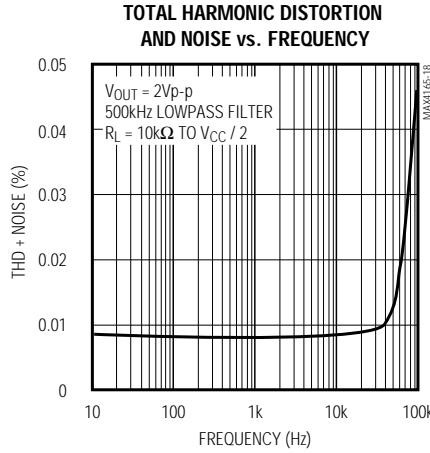
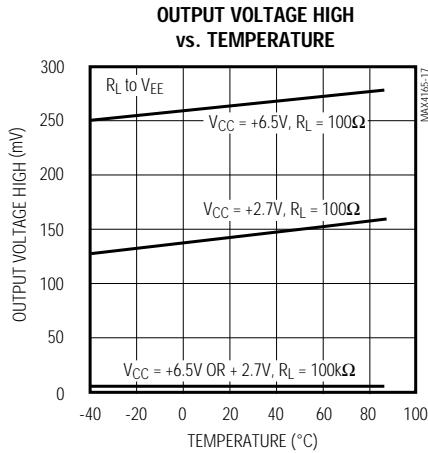

High-Output-Drive, Precision, Low-Power, Single-Supply, Rail-to-Rail I/O Op Amps with Shutdown

Pin Description

MAX4165	PIN						NAME	FUNCTION
	MAX4166		MAX4167	MAX4168		MAX4169		
	DIP/SO μMAX	μDFN		DIP/SO	μMAX			
1	6	4	—	—	—	—	OUT	Output
—	1, 5	2, 6	—	5, 7, 8, 10	—	—	N.C.	No Connection. Not internally connected.
—	—	—	1, 7	1, 13	1, 9	1, 7	OUT1, OUT2	Outputs for Amplifiers 1 and 2
2	4	3	4	4	4	11	V _{EE}	Negative Supply. Ground for single-supply operation.
3	3	1	—	—	—	—	IN+	Noninverting Input
—	—	—	2, 6	2, 12	2, 8	2, 6	IN1-, IN2-	Inverting Inputs for Amplifiers 1 and 2
4	2	7	—	—	—	—	IN-	Inverting Input
—	—	—	3, 5	3, 11	3, 7	3, 5	IN1+, IN2+	Noninverting Inputs for Amplifiers 1 and 2
5	7	5	8	14	10	4	V _{CC}	Positive Supply
—	—	—	—	6, 9	5, 6	—	$\overline{\text{SHDN1}}$, $\overline{\text{SHDN2}}$	Active-Low Shutdown Inputs for Amplifiers 1 and 2. Drive low for shutdown mode. Drive high or connect to V _{CC} for normal operation.
—	8	8	—	—	—	—	$\overline{\text{SHDN}}$	Active-Low Shutdown Input. Drive low for shutdown mode. Drive high or connect to V _{CC} for normal operation.
—	—	—	—	—	—	8, 14	OUT3, OUT4	Outputs for Amplifiers 3 and 4
—	—	—	—	—	—	9, 13	IN3-, IN4-	Inverting Inputs for Amplifiers 3 and 4
—	—	—	—	—	—	10, 12	IN3+, IN4+	Noninverting Inputs for Amplifiers 3 and 4

High-Output-Drive, Precision, Low-Power, Single-Supply, Rail-to-Rail I/O Op Amps with Shutdown

Applications Information

Package Power Dissipation

Warning: Due to the high output current drive, this op amp can exceed the absolute maximum power-dissipation rating. As a general rule, as long as the peak current is less than or equal to 80mA, the maximum package power dissipation will not be exceeded for any of the package types offered. There are some exceptions to this rule, however. The absolute maximum power-dissipation rating of each package should always be verified using the following equations. The following equation gives an approximation of the package power dissipation:

$$P_{IC(DISS)} \cong V_{RMS} I_{RMS} \cos \theta$$

where: V_{RMS} = the RMS voltage from V_{CC} to V_{OUT} when sourcing current

= the RMS voltage from V_{OUT} to V_{EE} when sinking current

I_{RMS} = the RMS current flowing out of or into the op amp and the load

θ = the phase difference between the voltage and the current. For resistive loads, $\cos \theta = 1$.

For example, the circuit in Figure 1 has a package power dissipation of 157mW.

$$\begin{aligned} V_{RMS} &\cong (V_{CC} - V_{DC}) - \frac{V_{PEAK}}{\sqrt{2}} \\ &= 6.5V - 3.25V - \frac{1.5V}{\sqrt{2}} = 2.189V_{RMS} \end{aligned}$$

$$\begin{aligned} I_{RMS} &\cong I_{DC} + \frac{I_{PEAK}}{\sqrt{2}} = \frac{3.25V}{60\Omega} + \frac{1.5V/60\Omega}{\sqrt{2}} \\ &= 71.84mA_{RMS} \end{aligned}$$

Therefore, $P_{IC(DISS)} = V_{RMS} I_{RMS} \cos \theta = 157mW$

Adding a coupling capacitor improves the package power dissipation because there is no DC current to the load, as shown in Figure 2.

$$\begin{aligned} V_{RMS} &\cong (V_{CC} - V_{DC}) - \frac{V_{PEAK}}{\sqrt{2}} \\ &= 6.5V - 3.25V - \frac{1.5V}{\sqrt{2}} = 2.189V_{RMS} \end{aligned}$$

$$\begin{aligned} I_{RMS} &\cong I_{DC} + \frac{I_{PEAK}}{\sqrt{2}} = 0A + \frac{1.5V/60\Omega}{\sqrt{2}} \\ &= 17.67mA_{RMS} \end{aligned}$$



Figure 1. A Circuit Example where the MAX4165/MAX4166 is Being Used in Single-Supply Operation

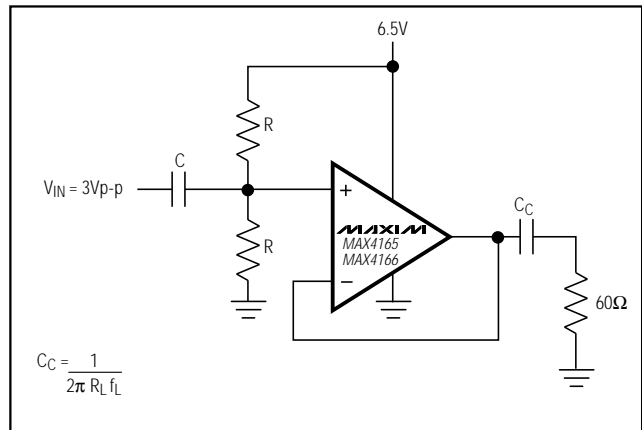

Figure 2. A Circuit Example where Adding a Coupling Capacitor Greatly Reduces the Power Dissipation of Its Package

Therefore, $P_{IC(DISS)} = V_{RMS} I_{RMS} \cos \theta = 38.6mW$

The absolute maximum power-dissipation rating of this package would be exceeded if the configuration in Figure 1 were used with all four of the MAX4169ESD's amplifiers at a high ambient temperature of +75°C (157mW x 4 amplifiers = 628mW + a derating of 8.33mW/°C x 5°C = 669mW). Note that 669mW just exceeds the absolute maximum power dissipation of 667mW for the 14-pin SO package (see the *Absolute Maximum Ratings* section).

High-Output-Drive, Precision, Low-Power, Single-Supply, Rail-to-Rail I/O Op Amps with Shutdown

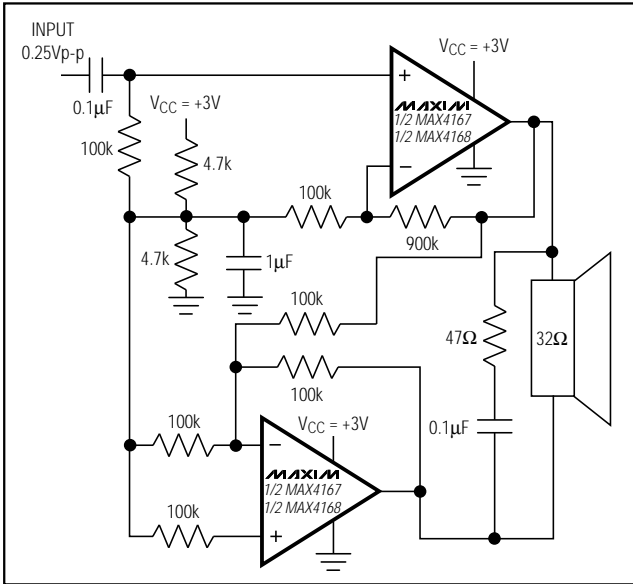

Figure 3. Dual MAX4167/MAX4168 Bridge Amplifier for 200mW at 3V

Single-Supply Speaker Driver

The MAX4165/MAX4166 can be used as a single-supply speaker driver, as shown in the *Typical Operating Circuit*. Capacitor C1 is used for blocking DC (a 0.1µF ceramic capacitor can be used). When choosing resistors R3 and R4, take into consideration the input bias current as well as how much supply current can be tolerated. Choose resistors R1 and R2 according to the amount of gain and current desired. Capacitor C3 ensures unity gain for DC. A 10µF electrolytic capacitor is suitable for most applications. The coupling capacitor C2 sets a low-frequency pole and is fairly large in value. For a 32Ω load, a 100µF coupling capacitor gives a low-frequency pole at 50Hz. The low-frequency pole can be set according to the following equation:

$$f = 1 / 2\pi (RLC2)$$

Bridge Amplifier

The circuit shown in Figure 3 uses a dual MAX4167/MAX4168 to implement a 3V, 200mW amplifier suitable for use in size-constrained applications. This configuration eliminates the need for the large coupling capacitor required by the single op-amp speaker driver when single-supply operation is a must. Voltage gain is set to +10V/V; however, it can be changed by adjusting the 900kΩ resistor value. DC voltage at the speaker is limited to 10mV. The 47Ω and 0.1µF capacitors across the speaker maintain a low impedance at the load as frequency increases.



Figure 4. Reducing Offset Error Due to Bias Current (Noninverting)



Figure 5. Reducing Offset Error Due to Bias Current (Inverting)

Rail-to-Rail Input Stage

Devices in the MAX4165-MAX4169 family of high-output-current amplifiers have rail-to-rail input and output stages designed for low-voltage, single-supply operation. The input stage consists of separate NPN and PNP differential stages that combine to provide an input common-mode range that extends 0.25V beyond the supply rails. The PNP stage is active for input voltages close to the negative rail, and the NPN stage is active for input voltages near the positive rail. The switchover transition region, which occurs near $V_{CC} / 2$, has been extended to minimize the slight degradation in common-mode rejection ratio caused by mismatch of the input pairs.

High-Output-Drive, Precision, Low-Power, Single-Supply, Rail-to-Rail I/O Op Amps with Shutdown

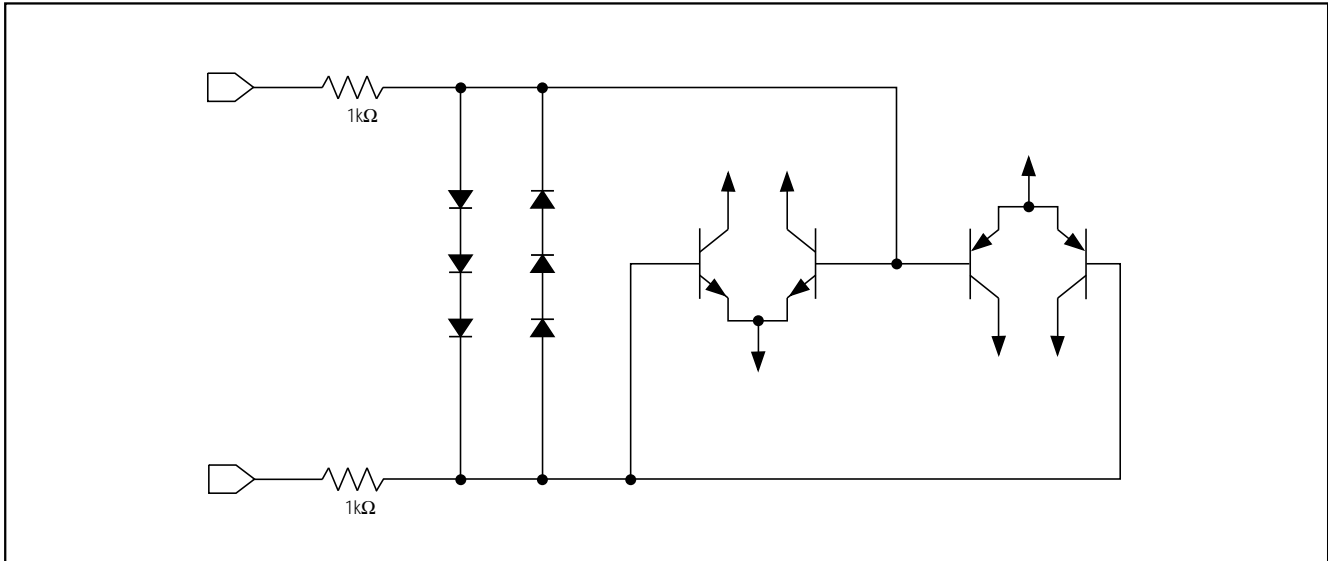

Figure 6. Input Protection Circuit

Since the input stage switches between the NPN and PNP pairs, the input bias current changes polarity as the input voltage passes through the transition region. Match the effective impedance seen by each input to reduce the offset error caused by input bias currents flowing through external source impedances (Figures 4 and 5).

High source impedances, together with input capacitance, can create a parasitic pole that produces an underdamped signal response. Reducing the input impedance or placing a small (2pF to 10pF) capacitor across the feedback resistor improves response.

The MAX4165–MAX4169's inputs are protected from large differential input voltages by 1kΩ series resistors and back-to-back triple diodes across the inputs (Figure 6).

For differential voltages less than 1.8V, input resistance is typically 500kΩ. For differential input voltages greater than 1.8V, input resistance is approximately 2kΩ. The input bias current is given by the following equation:

$$I_{BIAS} = (V_{DIFF} - 1.8V) / 2k\Omega$$

Rail-to-Rail Output Stage

The minimum output is within millivolts of ground for single-supply operation, where the load is referenced to ground (V_{EE}). Figure 7 shows the input voltage range and the output voltage swing of a MAX4165 connected as a voltage follower. The maximum output voltage swing is load dependent; however, it is guaranteed to be within 430mV of the positive rail ($V_{CC} = 5V$) even with maximum load (25Ω to ground).

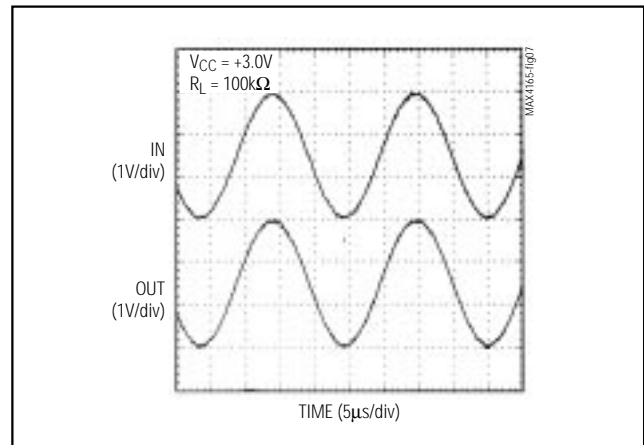

Figure 7. Rail-to-Rail Input/Output Range

Driving Capacitive Loads

The MAX4165–MAX4169 have a high tolerance for capacitive loads. They are stable with capacitive loads up to 250pF. Figure 8 is a graph of the stable operating region for various capacitive loads vs. resistive loads. Figures 9 and 10 show the transient response with excessive capacitive loads (1500pF), with and without the addition of an isolation resistor in series with the output. Figure 11 shows a typical noninverting capacitive-load-driving circuit in the unity-gain configuration. The resistor improves the circuit's phase margin by isolating the load capacitor from the op amp's output.

High-Output-Drive, Precision, Low-Power, Single-Supply, Rail-to-Rail I/O Op Amps with Shutdown

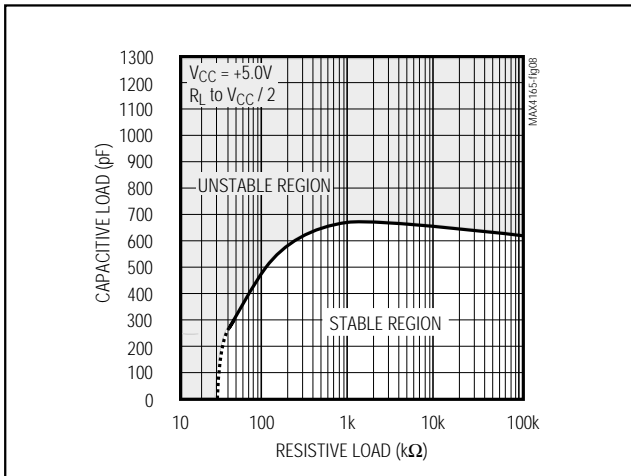

Figure 8. Capacitive Load Stability

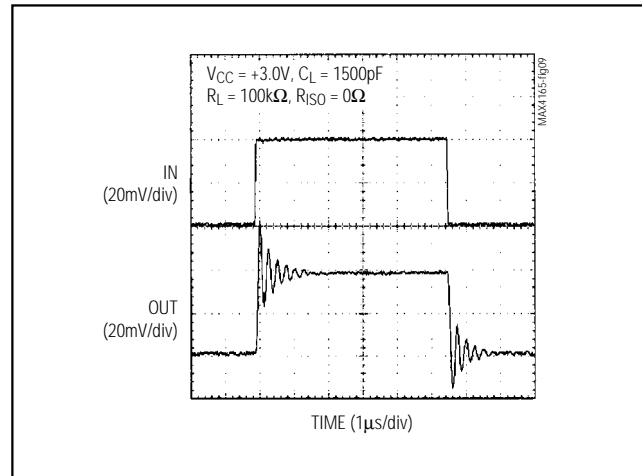

Figure 9. Small-Signal Transient Response with Excessive Capacitive Load

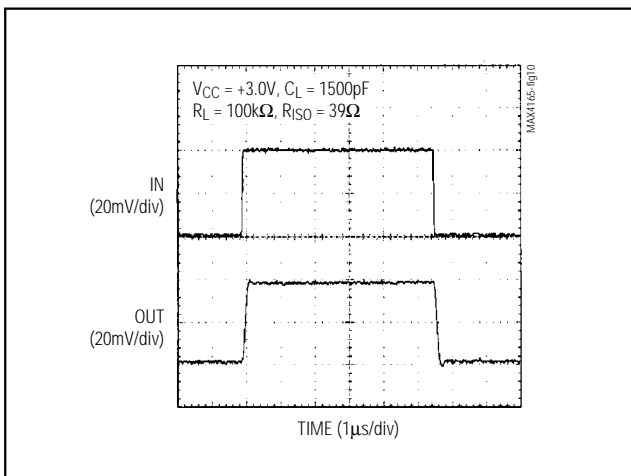

Figure 10. Small-Signal Transient Response with Excessive Capacitive Load with Isolation Resistor

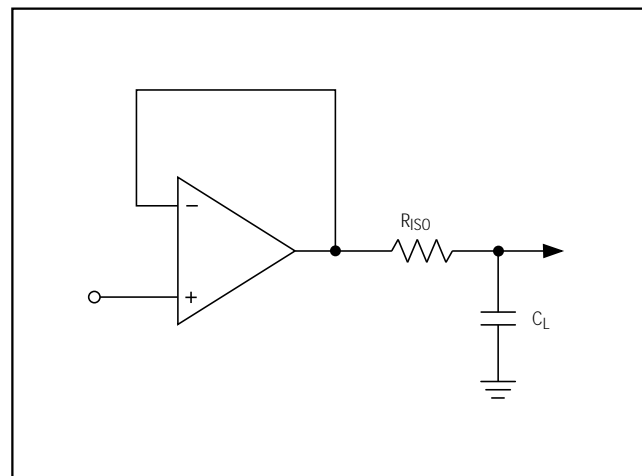

Figure 11. Capacitive-Load-Driving Circuit

Power-Up and Shutdown Modes

The MAX4166/MAX4168 have a shutdown option. When the shutdown pin ($\overline{\text{SHDN}}$) is pulled low, supply current drops to $58\mu\text{A}$ per amplifier ($V_{\text{CC}} = +5\text{V}$), the amplifiers are disabled, and their outputs are placed in a high-impedance state. Pulling $\overline{\text{SHDN}}$ high or leaving it floating enables the amplifier. In the dual MAX4168, the two amplifiers shut down independently. Figures 12 and 13 show the MAX4166's output voltage and supply-current responses to a shutdown pulse. The MAX4166-MAX4169 typically settle within $5\mu\text{s}$ after power-up (Figure 14).

Power Supplies and Layout

The MAX4165-MAX4169 can operate from a single $+2.7\text{V}$ to $+6.5\text{V}$ supply, or from dual $\pm 1.35\text{V}$ to $\pm 3.25\text{V}$ supplies. For single-supply operation, bypass the power supply with a $0.1\mu\text{F}$ ceramic capacitor in parallel with at least $1\mu\text{F}$. For dual-supply operation, bypass each supply to ground. Good layout improves performance by decreasing the amount of stray capacitance at the op amps' inputs and outputs. Decrease stray capacitance by placing external components close to the op amps' pins, minimizing trace and lead lengths.

High-Output-Drive, Precision, Low-Power, Single-Supply, Rail-to-Rail I/O Op Amps with Shutdown

MAX4165-MAX4169

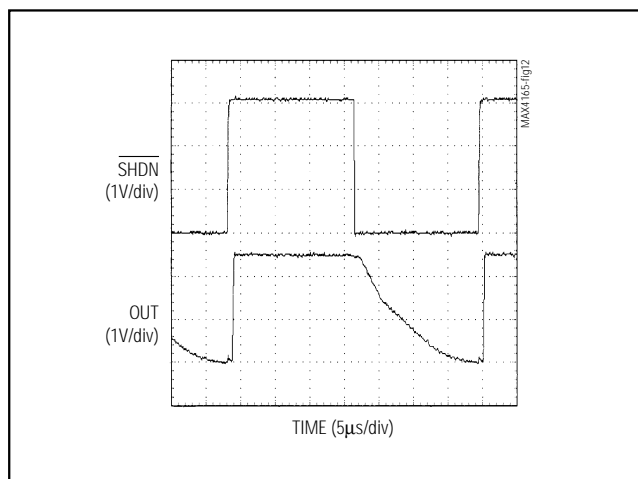

Figure 12. Shutdown Output Voltage Enable/Disable

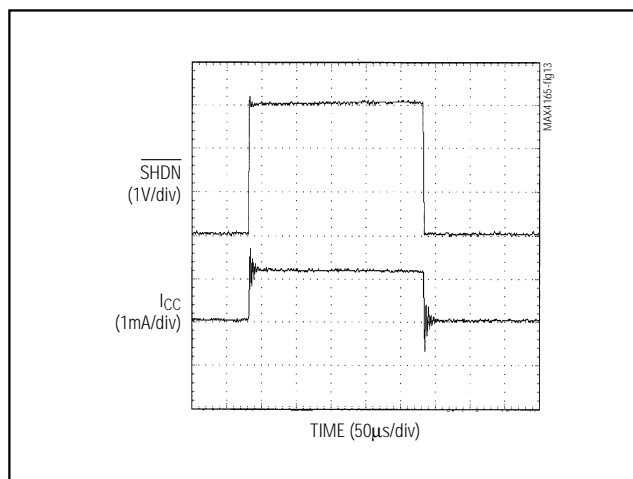

Figure 13. Shutdown Enable/Disable Supply Current

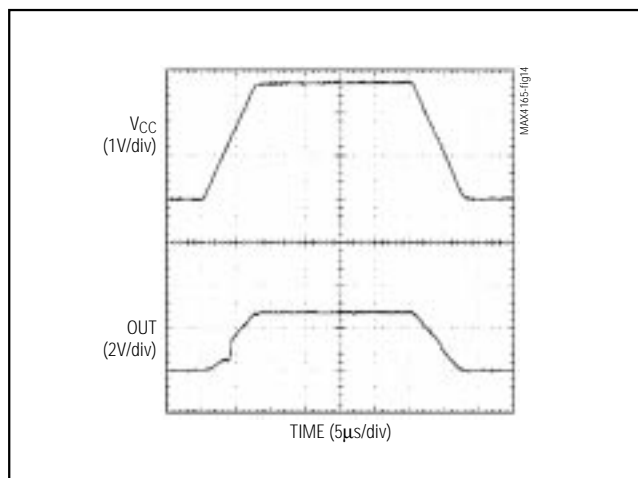

Figure 14. Power-Up/Down Output Voltage

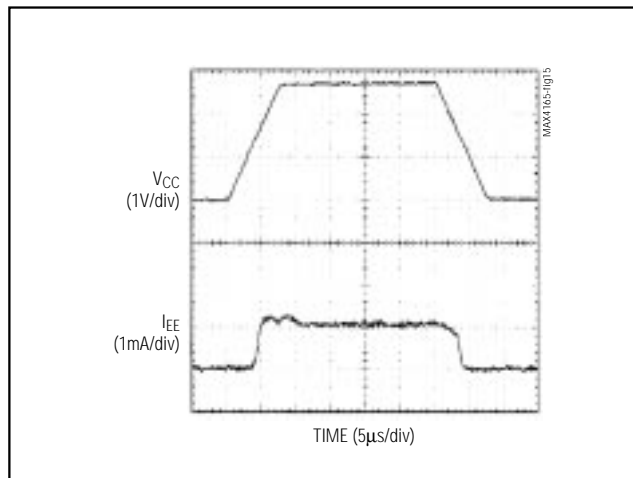
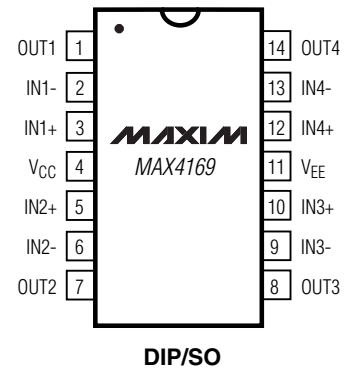
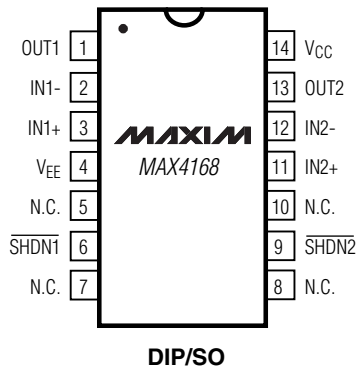
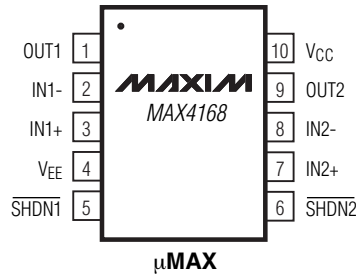
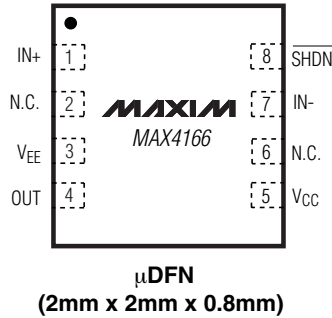

Figure 15. Power-Up/Down Supply Current

High-Output-Drive, Precision, Low-Power, Single-Supply, Rail-to-Rail I/O Op Amps with Shutdown

Pin Configurations (continued)

TOP VIEW



High-Output-Drive, Precision, Low-Power, Single-Supply, Rail-to-Rail I/O Op Amps with Shutdown

MAX4165-MAX4169

Typical Operating Circuit

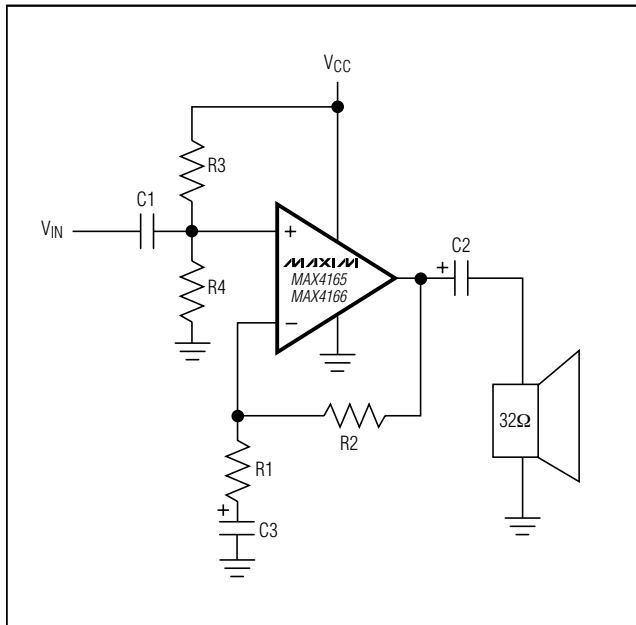

Ordering Information (continued)

PART	TEMP RANGE	PIN-PACKAGE	TOP MARK
MAX4167EPA	-40°C to +85°C	8 Plastic DIP	—
MAX4167ESA	-40°C to +85°C	8 SO	—
MAX4168EPD	-40°C to +85°C	14 Plastic DIP	—
MAX4168ESD	-40°C to +85°C	14 SO	—
MAX4168EUB	-40°C to +85°C	10 μMAX	—
MAX4169EPD	-40°C to +85°C	14 Plastic DIP	—
MAX4169ESD	-40°C to +85°C	14 SO	—

Chip Information

MAX4165 TRANSISTOR COUNT: 230
 MAX4166 TRANSISTOR COUNT: 230
 MAX4167 TRANSISTOR COUNT: 462
 MAX4168 TRANSISTOR COUNT: 462
 MAX4169 TRANSISTOR COUNT: 924

Package Information

(The package drawing(s) in this data sheet may not reflect the most current specifications. For the latest package outline information go to www.maxim-ic.com/packages.)

DIM	INCHES		MILLIMETERS	
	MIN	MAX	MIN	MAX
A	-	0.043	-	1.10
A1	0.002	0.006	0.05	0.15
A2	0.030	0.037	0.75	0.95
b	0.010	0.014	0.25	0.36
c	0.005	0.007	0.13	0.18
D	0.116	0.120	2.95	3.05
e	0.0256 BSC		0.65 BSC	
E	0.116	0.120	2.95	3.05
H	0.188	0.198	4.78	5.03
L	0.016	0.026	0.41	0.66
α	0°	6°	0°	6°
S	0.0207 BSC		0.5250 BSC	

NOTES:

- D&E DO NOT INCLUDE MOLD FLASH.
- MOLD FLASH OR PROTRUSIONS NOT TO EXCEED 0.15MM (.006").
- CONTROLLING DIMENSION: MILLIMETERS.
- MEETS JEDEC MO-187C-AA.

DALLAS SEMICONDUCTOR **MAXIM**

PROPRIETARY INFORMATION

TITLE: PACKAGE OUTLINE, 8L uMAX uSOP

APPROVAL	DOCUMENT CONTROL NO. 21-0036	REV. J	1/1
----------	------------------------------	--------	-----

High-Output-Drive, Precision, Low-Power, Single-Supply, Rail-to-Rail I/O Op Amps with Shutdown

Package Information (continued)

(The package drawing(s) in this data sheet may not reflect the most current specifications. For the latest package outline information go to www.maxim-ic.com/packages.)

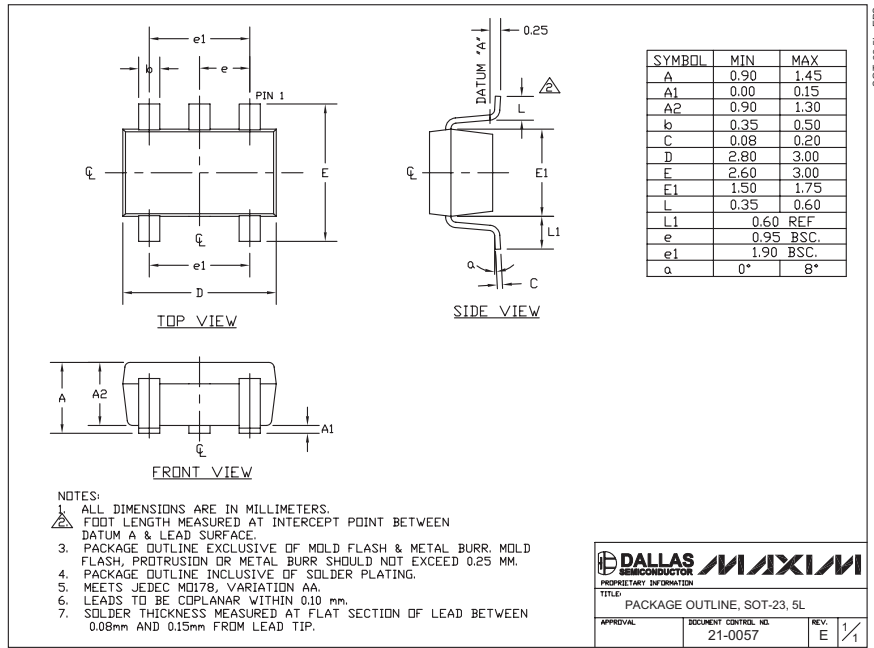

SOT-23 5L EFS

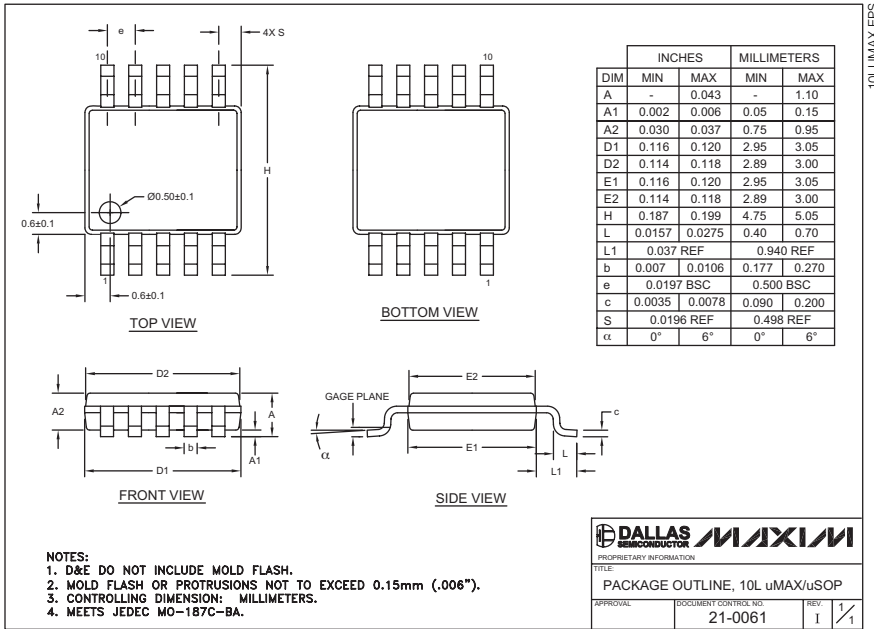

10L uMAX EFS

High-Output-Drive, Precision, Low-Power, Single-Supply, Rail-to-Rail I/O Op Amps with Shutdown

Package Information (continued)

(The package drawing(s) in this data sheet may not reflect the most current specifications. For the latest package outline information go to www.maxim-ic.com/packages.)

MAX4165-MAX4169

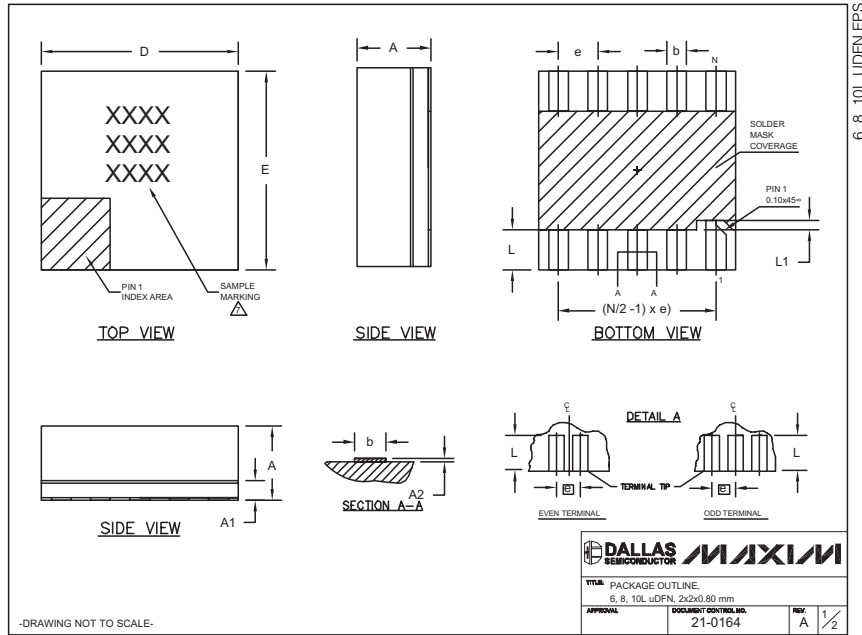

COMMON DIMENSIONS			
SYMBOL	MIN.	NOM.	MAX.
A	0.70	0.75	0.80
A1	0.15	0.20	0.25
A2	0.020	0.025	0.035
D	1.95	2.00	2.05
E	1.95	2.00	2.05
L	0.30	0.40	0.50
L1	0.10 REF.		

PACKAGE VARIATIONS				
PKG. CODE	N	e	b	(N/2 - 1) x e
L622-1	6	0.65 BSC	0.30±0.05	1.30 REF.
L822-1	8	0.50 BSC	0.25±0.05	1.50 REF.
L1022-1	10	0.40 BSC	0.20±0.03	1.60 REF.

NOTES:
 1. ALL DIMENSIONS ARE IN mm. ANGLES IN DEGREES.
 2. COPLANARITY SHALL NOT EXCEED 0.08mm.
 3. WARPAGE SHALL NOT EXCEED 0.10mm.
 4. PACKAGE LENGTH/PACKAGE WIDTH ARE CONSIDERED AS SPECIAL CHARACTERISTIC(S).
 5. "N" IS THE TOTAL NUMBER OF LEADS.
 6. NUMBER OF LEADS SHOWN ARE FOR REFERENCE ONLY.
 7. MARKING IS FOR PACKAGE ORIENTATION REFERENCE ONLY.

DALLAS SEMICONDUCTOR		MAXIM	
TITLE: PACKAGE OUTLINE 6, 8, 10L uDFN, 2x2x0.80 mm			
APPROVAL	DOCUMENT CONTROL, INC.	REV:	A 1/2
	21-0164		

-DRAWING NOT TO SCALE-

Maxim cannot assume responsibility for use of any circuitry other than circuitry entirely embodied in a Maxim product. No circuit patent licenses are implied. Maxim reserves the right to change the circuitry and specifications without notice at any time.

Maxim Integrated Products, 120 San Gabriel Drive, Sunnyvale, CA 94086 408-737-7600 _____ 17