

## Features

### Regulated Converters

- UL/ RAILWAYS Certified Constant Current LED Driver
- Wide Input and Output Voltage Range
- Digital PWM and Analogue Voltage Dimming
- Short Circuit Protected
- Pinned or Wired Versions
- IP67 rated for /W Version
- 96% Efficiency
- 5 year Warranty

### Description

The RCD series is a step-down constant current source designed for driving high power white LEDs. Standard output currents available are 300mA, 350mA, 500mA, 600mA, 700mA, 1000mA and 1200mA to make this driver compatible with a wide range of LEDs applications. Despite its compact size, the RCD series is fully featured with very high efficiency, wide input voltage range, high ambient operating temperature and two means of dimming: PWM/digital control and analogue voltage dimming. Both dimming controls are independent and can be combined. The driver is also designed to be as reliable as the LEDs it is driving, even at the full operating temperature. Options include an IP67-rated wired version (/W) and a version with built-in reference output voltage (/Vref) to power sensors or for easy analogue dimming.

### Selection Guide

Part Number	Input Range (VDC)	Output Current (mA)	Output Voltage (Vmin-Vmax)	Dimming Control	Options	Mounting Style
RCD-24-0.30 <sup>(a)(b)</sup>	4.5-36V	0-300	2-35	Digital + Analogue	Vref	Pins or Wired
RCD-24-0.35 <sup>(a)(b)</sup>	4.5-36V	0-350	2-35	Digital + Analogue	Vref	Pins or Wired
RCD-24-0.50 <sup>(a)(b)</sup>	4.5-36V	0-500	2-35	Digital + Analogue	Vref	Pins or Wired
RCD-24-0.60 <sup>(a)(b)</sup>	4.5-36V	0-600	2-35	Digital + Analogue	Vref	Pins or Wired
RCD-24-0.70 <sup>(a)(b)</sup>	4.5-36V	0-700	2-35	Digital + Analogue	Vref	Pins or Wired
RCD-24-1.00 <sup>(b)</sup>	6-36V	0-1000	3-31	Digital + Analogue		Pins or Wired
RCD-24-1.20 <sup>(b)</sup>	6-36V	0-1200	3-31	Digital + Analogue		Pins or Wired

<sup>(a)(b)</sup> Standard is no suffix with PCB Pins.

<sup>(a)</sup> Add suffix /Vref for pinned version with Vref output and analogue dimming

<sup>(b)</sup> Add suffix /W for wired version without dimming control (four wires)

<sup>(b)</sup> Add suffix /W/X1 for wired version with analogue dimming control (five wires)

<sup>(b)</sup> Add suffix /W/X2 for wired version with PWM dimming control (five wires)

<sup>(b)</sup> Add suffix /W/X3 for wired version with both analogue and PWM dimming controls (six wires)

<sup>(a)</sup> Add suffix /W/Vref for wired version with Vref output and analogue dimming (six wires)

### Specifications (typical at 25°C, nominal input voltage, rated output current unless otherwise specified )

Input Voltage (absolute maximum)	40VDC max	
Recommended Input Voltage	300mA-700mA	5V min. / 24V typ. / 36VDC max
	1000mA-1200mA	6V min. / 24V typ. / 36VDC max
Input Filter	Capacitor	
Output Current Accuracy (Vin = 24DC)	300mA-700mA	±1% typ, ±3% max.
	1000mA-1200mA	±2% typ, ±5% max.
Internal Power Dissipation	Worst case load of 5 LEDs	800mW max
Output Current Stability	Vin=36V, Vout =1-9 LEDs	±1% max
Output Ripple and Noise (20MHz BW) Vin=36V, Vout =1-9 LEDs	300mA-700mA	150mVp-p max
	1000mA-1200mA	300mVp-p max
Temperature Coefficient	-40°C to +85°C ambient	±0.015%/°C max
Maximum Capacitive Load	100µF	
Operating Frequency	300mA-700mA	210kHz min/ 250kHz typ/ 280kHz max
	1000mA-1200mA	350kHz min/ 450kHz typ/ 550kHz max
Efficiency at Full Load	96% max.	
Short Circuit Protection	Regulated at rated output current	

continued on next page

## LIGHTLINE

### DC/DC-Converter

with 5 year Warranty

# RECOM

## Constant Current LED Driver



**E358085**

**EN-50121-3-2 Certified**  
**EN-60950-1 Certified**  
**UL-60950-1 Certified**

## RCD-24

## Derating-Graph

(Ambient Temperature)



Refer to Application Notes

### Specifications (typical at 25°C, nominal input voltage, rated output current unless otherwise specified)

Operating Temperature Range (free air convection)	300mA-350mA	-40°C to +85°C
	500mA	-40°C to +80°C
	600mA	-40°C to +75°C
	700mA-1000mA	-40°C to +71°C
	1200mA	-40°C to +65°C

Storage Temperature Range		-55°C to +125°C
Maximum Case Temperature		100°C
Thermal Impedance	Natural Convection	55°C/Watt
Case Material (Pinned or Wired Versions)	Non Conductive Black Plastic	
Potting Material (Pinned or Wired Versions)	Epoxy (UL94-V0)	
Dimensions	Pinned/Wired	22.1 x 12.6 x 8.5mm
Weight	Pinned/Wired	4.5g/6.8g
Soldering Profile	Pinned	265°C/10 sec. max
Packing Quantities (Refer to App Notes for Tube sizes)	Pinned Versions	39pcs per Tube
	Wired Versions	5pcs per Bag

### PWM Dimming and ON/OFF Control (Leave open if not used - do not tie to +Vin)

Remote ON/OFF	DC/DC ON	300mA-700mA	Open or $0V < V_r < 0.6V$
Threshold Voltages		1000mA-1200mA	Open or $0V < V_r < 0.8V$
	DC/DC OFF (Standby)	300mA-700mA	$0.6 < V_r < 2.9V$
		1000mA-1200mA	$1.4 < V_r < 2.2V$
	DC/DC OFF (Shutdown)	300mA-700mA	$2.9V < V_r < 6V$
		1000mA-1200mA	$2.2V < V_r < 15V$
	Remote Pin Drive Current	$V_r = 5V$	1mA max
Quiescent Input Current in Shutdown Mode	$V_{in} = 36V$		200µA max
Maximum PWM Frequency	For Linear Operation		200Hz max.
	Frequency Limit		1000Hz max.

### Analogue Dimming Control (leave open if not used - do not tie to +Vin)

Input Voltage Limits	Standard	-0.3V - 15V
	Vref Version	-0.3V - 5V
Control Voltage Range (see Graphs)	Full On	$0.13V \pm 50mV$
	300, 700, 1200mA: Full Off	$4.2V \pm 150mV$
	1000mA: Full Off	$4.35V \pm 100mV$
	Vref Version: Full Off	$2.6V \pm 100mV$
	Vc=5V	0.2mA max.
Analogue Pin Drive Current	Vref Voltage	$3.3V \pm 70mV$
	Vref Output Current	5mA
	Vref Output Short Circuit Current	18mA typ.

### Environmental

Relative Humidity	5% to 95% RH, non-condensing	
/W Versions	IP67	
Shock / Vibration	EN61373	
EMC Railways	EN50121-3-2:2006	
Conducted Emissions	(with filter, see note)	EN55022 Class B
Radiated Emissions	(all series except >700mA)	EN55022 Class B
ESD		EN61000-4-2 Criterion A
Radiated Immunity		EN61000-4-3 Criterion A
Fast Transient		EN61000-4-4 Criterion A
Conducted Immunity		EN61000-4-6 Criterion A
MTBF (RCD-24-0.70, Nominal Vin, Full Load) using MIL-HDBK 217F	+25°C	$605 \times 10^3$ hours
	+71°C	$516 \times 10^3$ hours
Safety Standards	EN General Safety	Report: SPCLVD1109081EN60950-1 2nd Edition
	EMC Railway	Report: 12A082105E-C EN50121-3-2
	UL General Safety	Report: E358085-A3 UL60950-1 CSA C22.2 No 60950-1-03

### Note:

- Requires an input filter to meet EN55022 Class B conducted emissions - see next page
- All LED Drivers may not be used without a load. They must be switched on the primary side only. Noncompliance may damage the LED or reduce its lifetime.

### Digital Dimming

PWM Digital Control Signal



Output Current (LED appears dim)



PWM Digital Control Signal

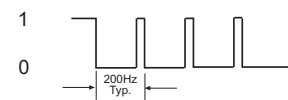

Output Current (LED appears bright)



### Analogue Dimming

#### Standard Version:



#### Vref Version:



### Combined PWM and Analogue Dimming

PWM Digital Control Signal

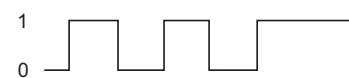

Output Current

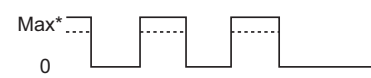

\* Max output current can also be set using Analogue input

## Typical Characteristics



## Standard Application Circuit (no external components required for normal use)



## EMI Filter Suggestions



RCD-24-0.30 - RCD-24-0.70

C1 = 1µF MLCC  
 L1 = 22µH

RCD-24-1.00 - RCD-24-1.20

C1 = 2.2µF MLCC  
 L1 = 47µH



## Recommended Class B PCB Layout for Pinned Version



RCD-24-0.30 - RCD-24-0.70

No dimming or PWM dimming:  
 L1 = 47µH  
 C2 = C3 = 10nF MLCC  
 Other caps not required  
 Analogue Dimming used:  
 L1 = 120µH  
 C2 = C7 = 10nF MLCC  
 Other caps not required

RCD-24-1.00 - RCD-24-1.20

L1 = 220µH  
 C2 = 10nF  
 C3 = C5 = 2.2nF  
 C4 = C6 = C7 = C8 = 100nF  
 All capacitors MLCC  
 C2\* = optional 2µ2 MLCC only if L1 starts to resonate with the back ripple current.

## Application Examples

### LED DRIVER with 0-10V Interface



### LED DIMMER for up to 10 white LEDs



### MULTIPLE LED DRIVER (up to 20 LEDs)



### LED DIMMER with high frequency PWM control



Driving Two Strings of 350mA LEDs with one 700mA Driver using a current mirror

Note:

It is not possible to parallel the drivers to increase the current.

## LED Temperature Monitoring

### Automatic LED Overtemperature Protection

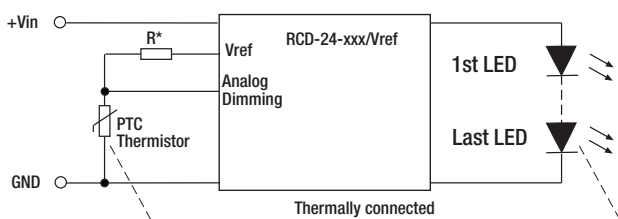

\*Typically, choose R so that  $R=R_{ptc} @ 85^{\circ}C$  and  $R > 660 \Omega$ .

### Typical Response Curve (PTC = 500 Ohm @ 70°C)

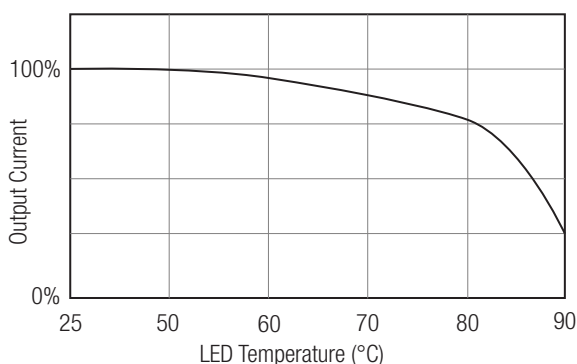

## RGB Driver

### SIMPLE RGB Mixer

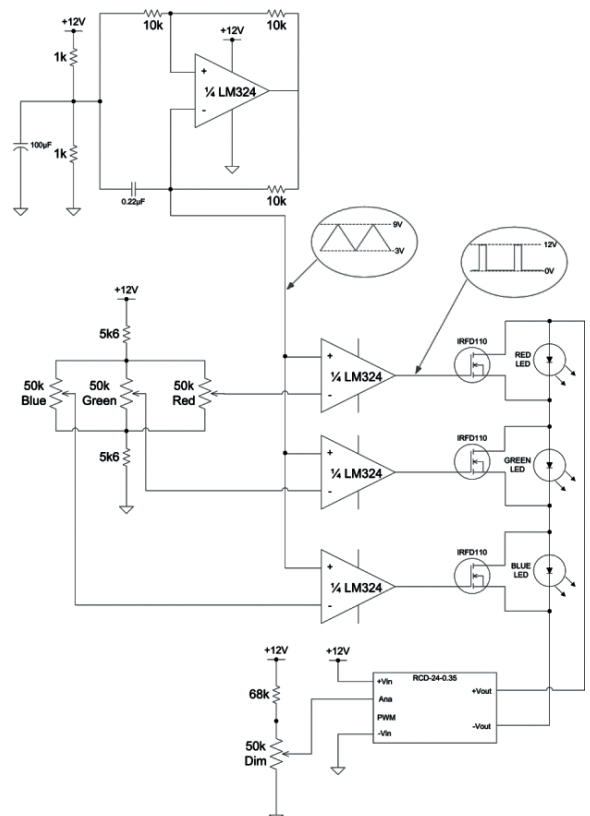

**Package Style and Pinning**

**Pinned Version**



Pin Connections		RCD-24 Series	
Pin #	Out	Comments	
1	+Vin	DC Supply	
2	Analogue Dimming	Leave open if not used	
3	PWM/ON/OFF	Leave open if not used	
(3	Vref	Vref Version only)	
4	GND	Do not connect to -Vout	
5	-Vout	LED Cathode Connection	
6	+Vout	LED Anode Connection	

XX.X ± 0.5 mm  
XX.XX ± 0.25 mm  
Pin Tolerance ± 0.1 mm

Leave >1mm space around case on PCB for air circulation

**Recommended Footprint Details**



**Wired Versions**



Wire Connections		RCD-24/W Series	
Wire #	Function	Comments	
1 (Red)	+Vin	DC Supply	
4 (Black)	GND	Do not connect to -Vout	
5 (Brown)	-Vout	LED Cathode Connection	
6 (Yellow)	+Vout	LED Anode Connection	

Wire length = 100mm + 10mm stripped & tinned = 110mm total  
Wire outside diameter = 1.6mm  
Wire core diameter = 0.75mm  
Wire is UL/CSA listed/ 22AWG / 300V Rated

**RCD-24**

**Package Style and Pinning**

**Wired Versions**

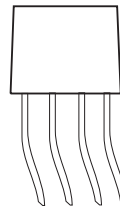
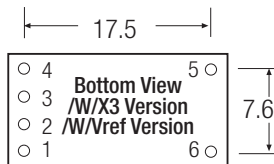
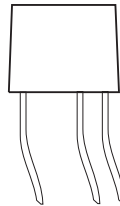
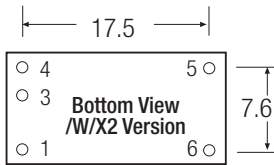
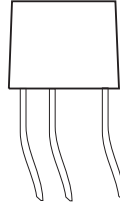
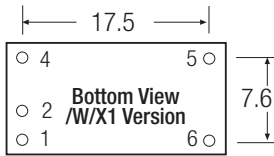

Wire Connections	RCD-24/W/X Series	
Wire #	Function	Comments
2 (Green)	Ana Dimming	/X1
3 (Blue)	PWM Dimming	/X2
2 + 3 (Green + Blue)	Ana + PWM Dimming	/X3
2 + 3 (Green + Yellow)	Ana Dimming + Vref	/Vref

Wire length = 100mm + 10mm stripped & tinned = 110mm total  
 Wire outside diameter = 1.6mm  
 Wire core diameter = 0.75mm  
 Wire is UL/CSA listed/ 22AWG / 300V Rated

Wired Versions are packed in bags - 5pcs per bag.

**Warning: Do not connect or disconnect the LED load while the converter is powered on. This may damage or reduce the lifetime of the LED.**