

Bluetooth / WLAN / WiFi Ceramic Chip Antenna

Ground cleared under antenna, clearance area 4.00 x 4.25/6.25 mm. Pulse Part Number W3008, W3008C



Features

- Omni directional radiation
- Low profile
- Compact size W x L x H (3.2 x 1.6 x 1.1 mm)
- Low weight (33 mg)
- Fully SMD compatible
- Lead free soldering compatible
- Tape and reel packing
- RoHS Compliant Product

Applications

- Bluetooth, WLAN, WiFi
- IEEE 802.11b/g
- ZigBee IEEE 802.15.4
- 2.4 GHz WLAN
- 2.4 GHz ISM Band Systems

Electrical specifications @ +25 °C

Note: Electrical characteristics depend on test board (GP) size and antenna positioning on GP and Ground Clearance area size.

Bluetooth, W3008

Typical performance (test board size 80x37 mm, PWB ground clearance area 4.00 x 4.25 mm)

Frequency Range [MHz]	Linear Max Gain [dBi]	Efficiency [%] / [dB]	Return loss min. [dB]	Impedance [Ω]	Operating Temperature [°C]
2400–2483.5	1.7 (Peak) 0.7 (Band edges)	70 / -1.6 (Peak) 55 / -2.6 (Band edges)	-8	50	-40 to +85

Bluetooth / WLAN / WiFi, W3008C

Typical performance (test board size 80x37 mm, PWB ground clearance area 4.00 x 6.25 mm)

Frequency Range [MHz]	Linear Max Gain [dBi]	Efficiency [%] / [dB]	Return loss min. [dB]	Impedance [Ω]	Operating Temperature [°C]
2400–2483.5	2.2 (Peak) 1.9 (Band edges)	75 / -1.3 (Peak) 70 / -1.6 (Band edges)	-11	50	-40 to +85

Pulse Finland Oy

Takatie 6
90440 Kempele, Finland
Tel: +358 207 935 500
Fax: +358 207 935 501
www.pulseeng.com/antennas



Bluetooth / WLAN / WiFi Ceramic Chip Antenna

Terminal Configuration

PWB Layout

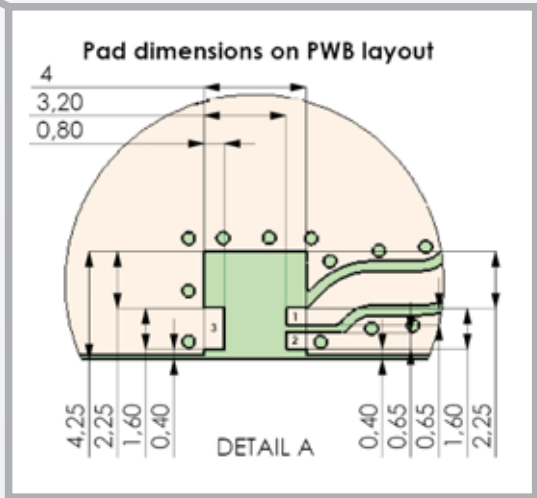
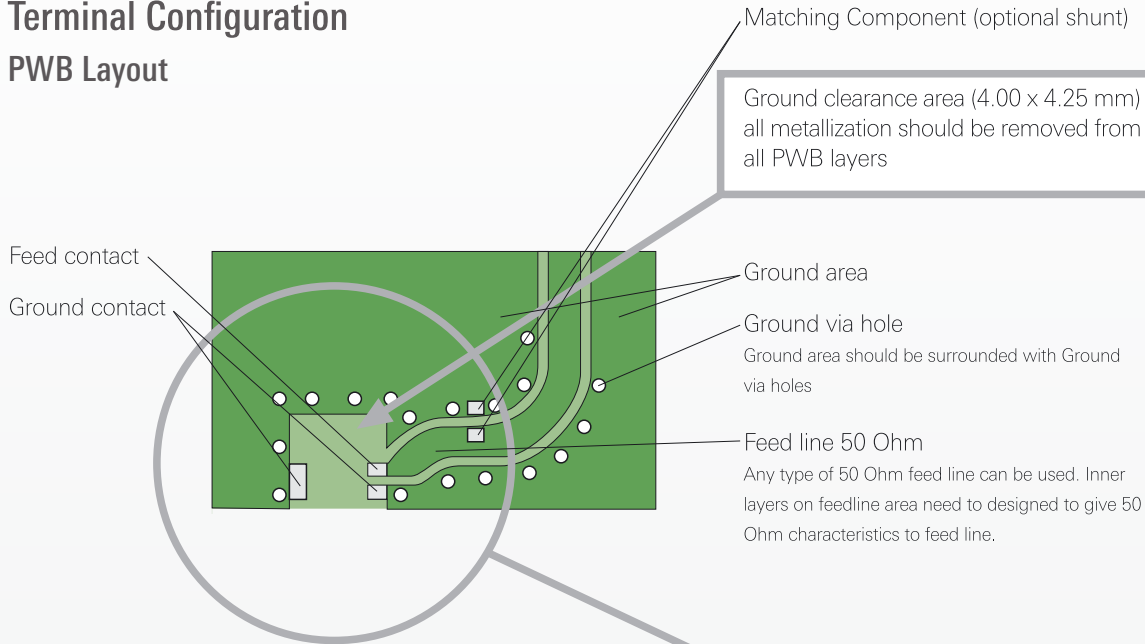

PWB features

No.	Terminal name	Terminal Dimensions
1	Feed	0.8 x 0.65 mm
2	GND	0.8 x 0.65 mm
3	GND	0.8 x 1.60 mm

Pulse Finland Oy

Takatie 6
90440 Kempele, Finland
Tel: +358 207 935 500
Fax: +358 207 935 501
www.pulseeng.com/antennas



Bluetooth / WLAN / WiFi Ceramic Chip Antenna

Terminal Configuration

PWB Layout

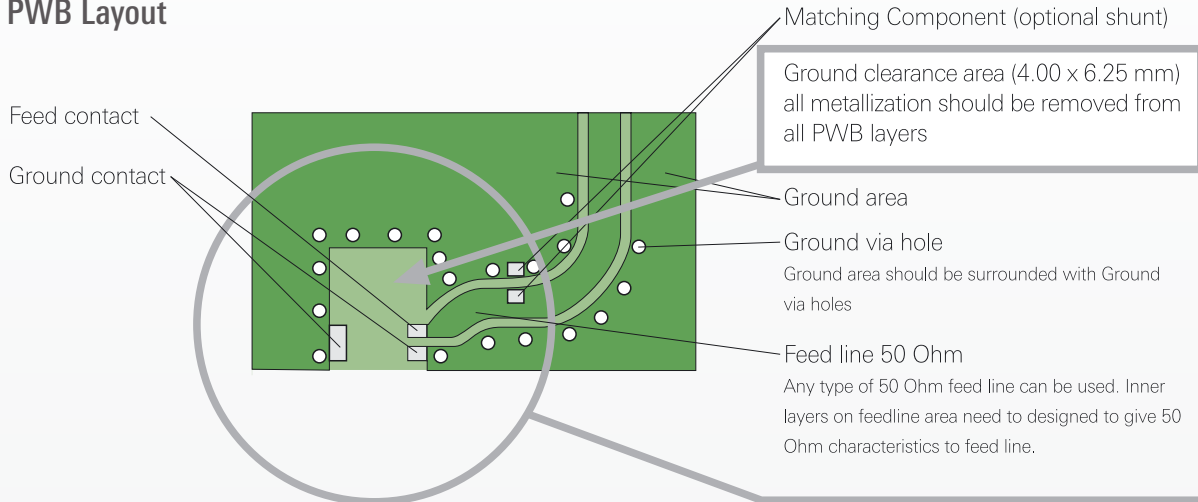

Antenna

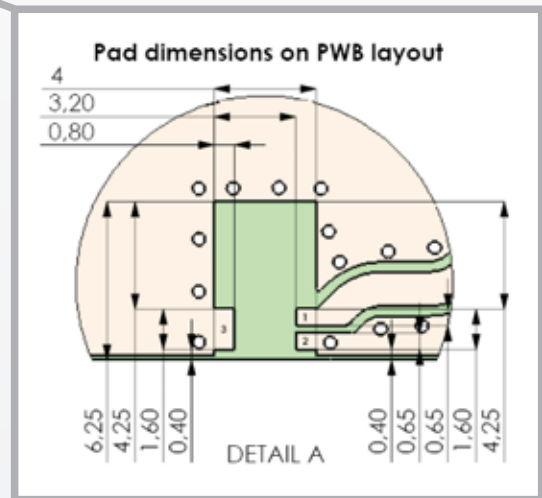
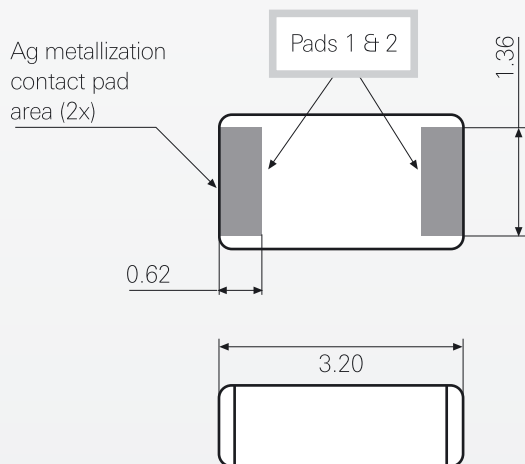

Antenna features

No.	Terminal name	Terminal Dimensions
1	Feed / GND	0.62 x 1.36 mm
2	Feed / GND	0.62 x 1.36 mm

Antenna is symmetrical.

Either of terminals 1 or 2 can be feed / GND

PWB features

No.	Terminal name	Terminal Dimensions
1	Feed	0.8 x 0.65 mm
2	GND	0.8 x 0.65 mm
3	GND	0.8 x 1.60 mm

Bluetooth / WLAN / WiFi Ceramic Chip Antenna

Typical Electrical Characteristics (T=25 °C), W3008

Typical Return Loss S11/ impedance, measured on the test board

BT

20 Oct 2005 12:37:16

CH1 S11&MLOG 5 dB/REF 0 dB

CH1Markers

1. -8.1915 dB 2.40000 GHz
2. -18.312 dB 2.440.000.000 MHz
3. -8.2296 dB 2.48350 GHz

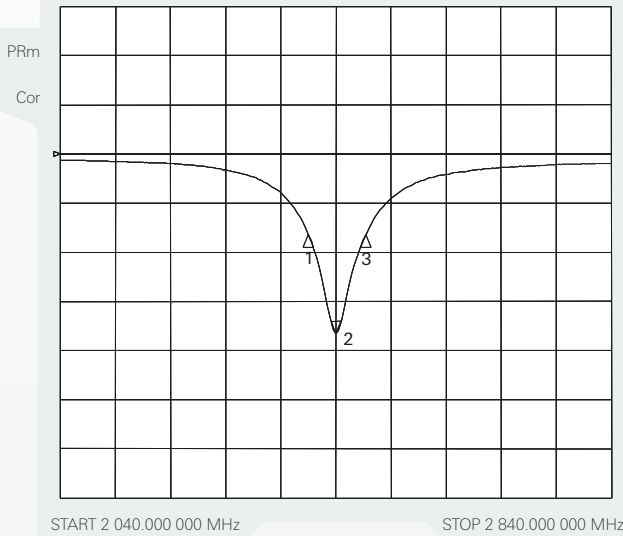

BT

20 Oct 2005 12:39:25

CH1Markers

- | | | |
|-------------------|-----------|-------------|
| 1. 27.585 Ω | 22.421 Ω | 2.40000 GHz |
| 2. 62.148 Ω | 6.8613 Ω | 447.55 pH |
| 2.440.000.000 MHz | | |
| 3. 45.029 Ω | -40.875 Ω | 2.48350 GHz |

CH1 S11&M1 U FS

PRm

Del

Cor

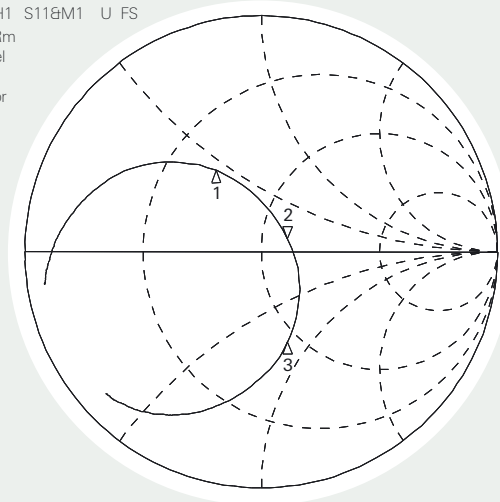

Free space efficiency and maximum gain / PWB ground clearance area 4.00 x 4.25 mm

BT GC 3.2 x 1.6 x 1.1 mm

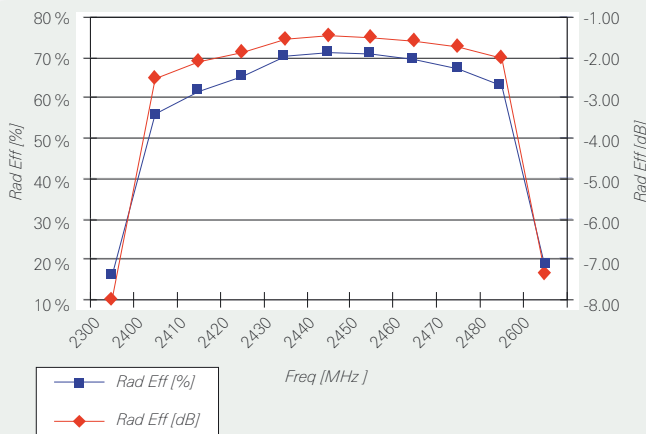

BT GC 3.2 x 1.6 x 1.1 mm

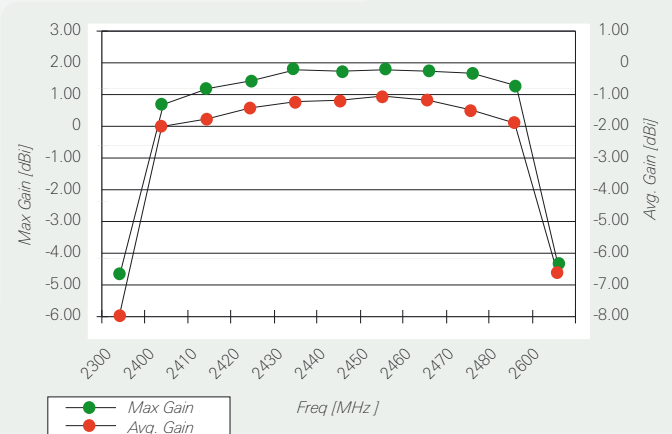

Pulse Finland Oy

Takatie 6
90440 Kempele, Finland
Tel: +358 207 935 500
Fax: +358 207 935 501
www.pulseeng.com/antennas



Bluetooth / WLAN / WiFi Ceramic Chip Antenna

Typical Free Space Radiation Patterns, W3008

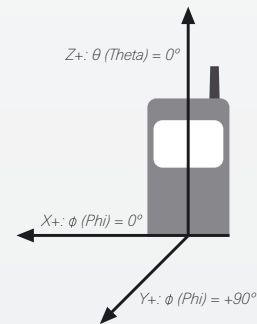
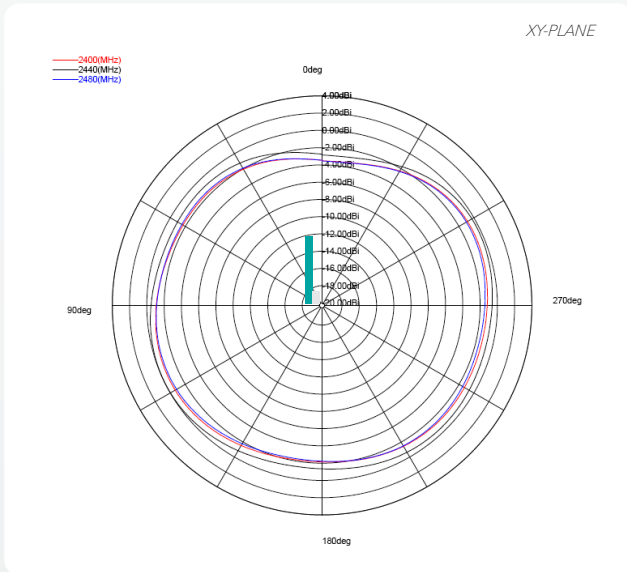
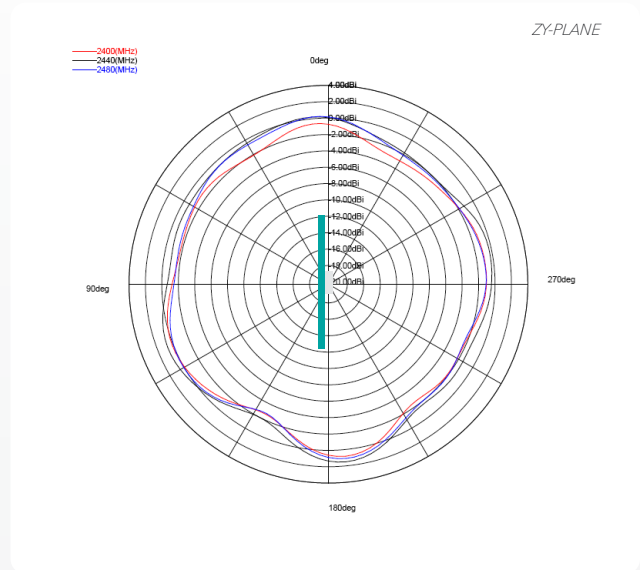
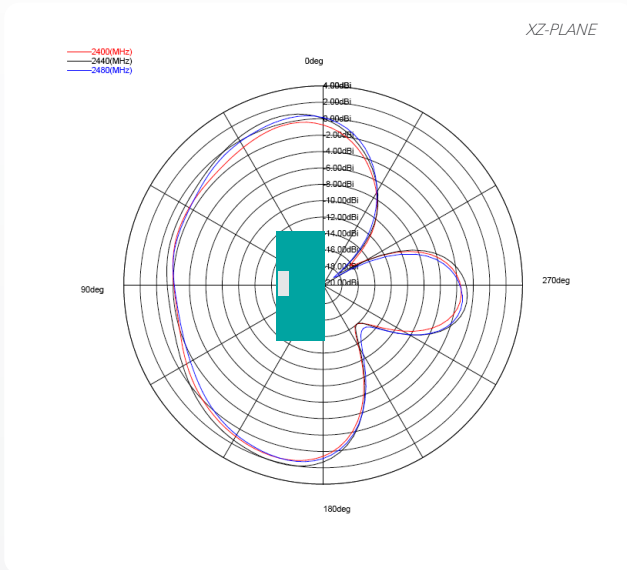

Pulse Finland Oy

Takatie 6
90440 Kempele, Finland

Tel: +358 207 935 500

Fax: +358 207 935 501

www.pulseeng.com/antennas



Bluetooth / WLAN / WiFi Ceramic Chip Antenna

Typical Electrical Characteristics (T=25 °C), W3008C

Typical Return Loss S11/ impedance, measured on the test board

BT/WLAN

20 Oct 2005 12:36:03

CH1 S11&MLOG 5 dB/REF 0 dB

CH1Markers

1. -11.415 dB 2.40000 GHz
2. -11.464 dB 2.440.000 000 MHz
3. -27.875 dB 2.48350 GHz

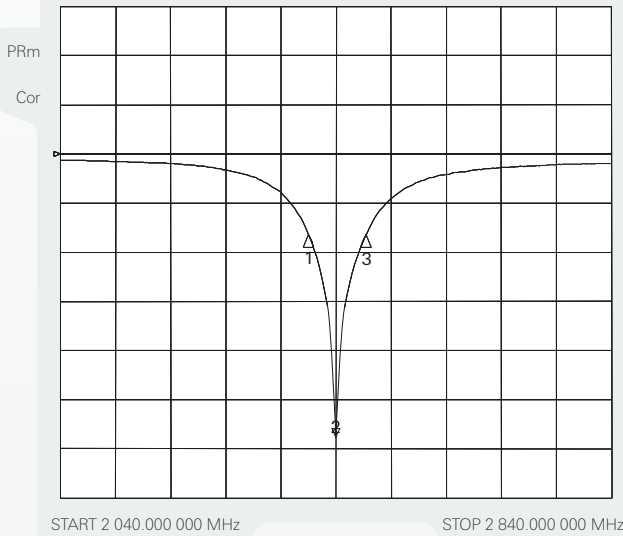

BT/WLAN

20 Oct 2005 12:39:25

CH1Markers

1. 40.141 Ω 24.354 Ω 2.40000 GHz
2. 55.264 Ω 1.3613 Ω 88.796 pH
3. 40.658 Ω -25.082 Ω 2.48350 GHz

CH1 S11&M1 U FS
PRm
Del
Cor

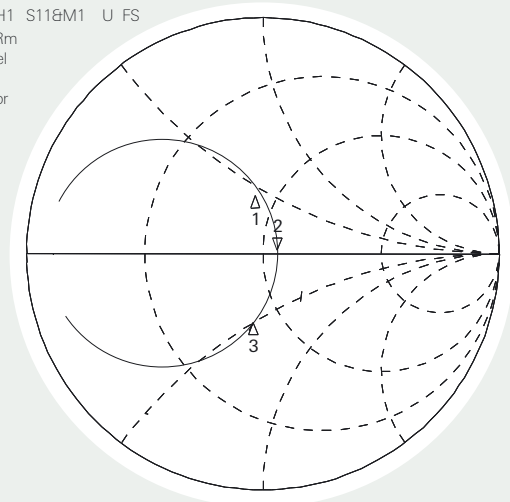

Free space efficiency and maximum gain / PWB ground clearance area 4.00 x 6.25 mm

BT GC 3.2 x 1.6 x 1.1 mm

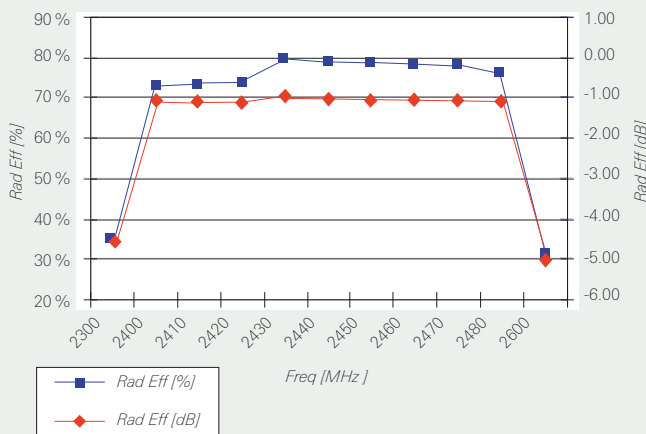

BT GC 3.2 x 1.6 x 1.1 mm

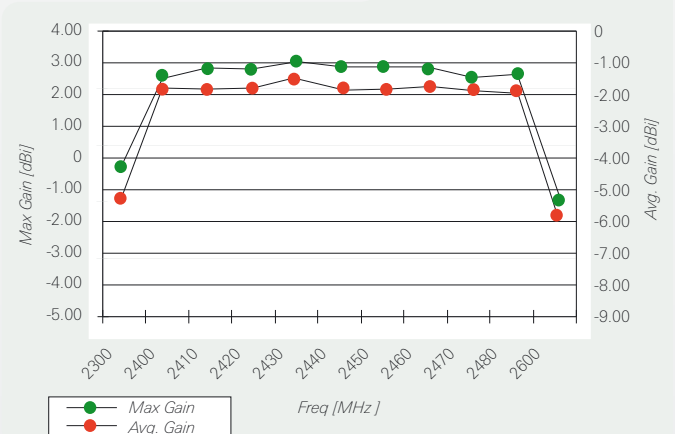

Pulse Finland Oy

Takatie 6
90440 Kempele, Finland
Tel: +358 207 935 500
Fax: +358 207 935 501
www.pulseeng.com/antennas



Bluetooth / WLAN / WiFi Ceramic Chip Antenna

Typical Free Space Radiation Patterns , W3008C

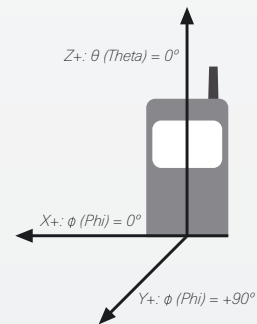
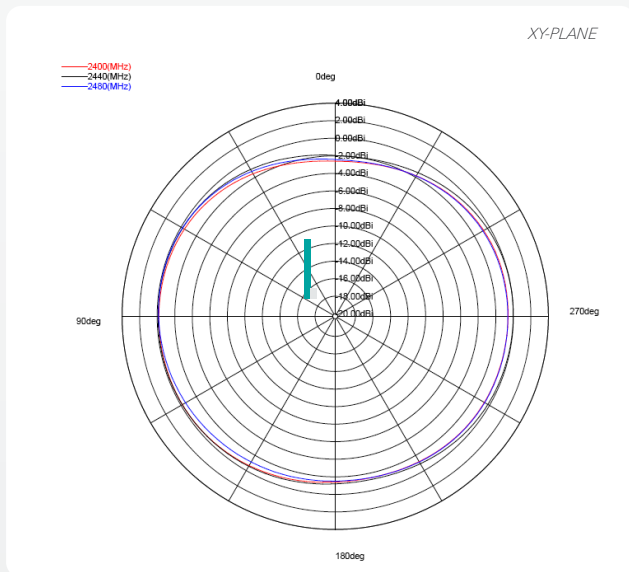
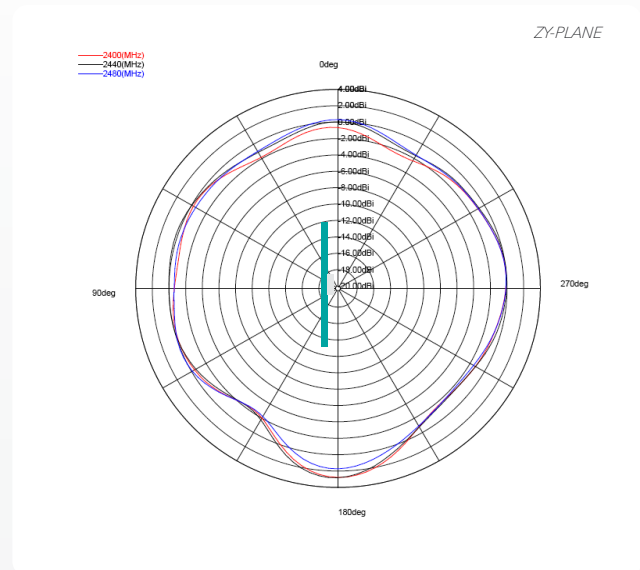
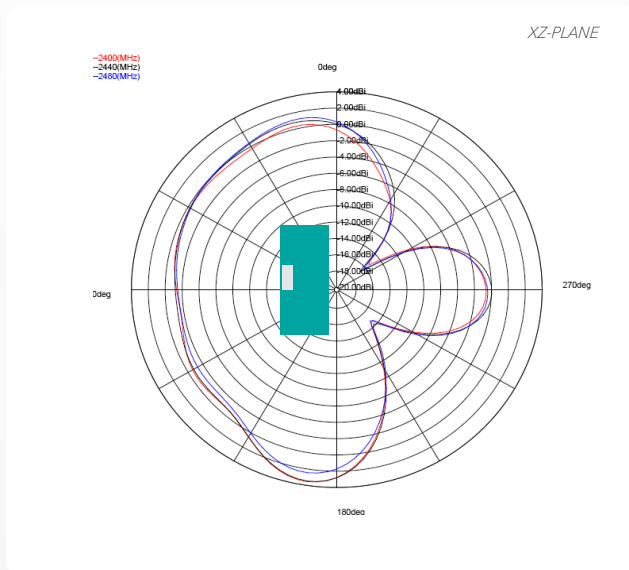

Pulse Finland Oy

Takatie 6
 90440 Kempele, Finland
 Tel: +358 207 935 500
 Fax: +358 207 935 501

www.pulseeng.com/antennas



Bluetooth / WLAN / WiFi Ceramic Chip Antenna

Packing Form

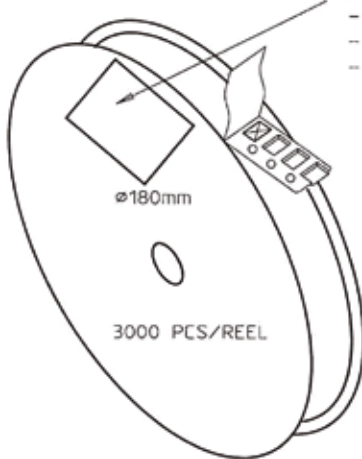

ø180mm
3000 PCS/REEL

REEL LABEL INFORMATION:

- TRACEABILITY
- QUANTITY
- PRODUCT CODE

CARRIER TAPE H85-00125
width=8,00 depth=1,22
COVER TAPE H85-00126
width=5,60

LENGTH OF TAPE:

- Leader section: 50 empty cavities before component section
- Trailer section: 25 empty cavities after component section.

Empty part cavities at leader and trailer section of the tape must be sealed with top cover tape.

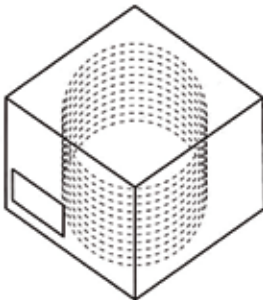

BOX H85-00128 (182x182x132)	1 pcs
- LABEL	1 pcs/BOX
REEL H85-00127 (D180, W12)	10 pcs
- REEL LABEL	1 pcs/REEL

MATERIAL					
HANDLINGS					
		RATIO	DRWN	010305 PeHa H	
			DGNER		G
			CHKD		F
			APPRD		E
PRODUCT	H90-OY116-F01P01		APPRD BY		D
DENOMINATION	PACKING FORM				C
					B
					A
		VERSION	MOD/DATE/NAME		

Pulse Finland Oy

Takatie 6
90440 Kempele, Finland
Tel: +358 207 935 500
Fax: +358 207 935 501
www.pulseeng.com/antennas

