

# IR Sensor Module for Reflective Sensor, Light Barrier, and Fast Proximity Applications

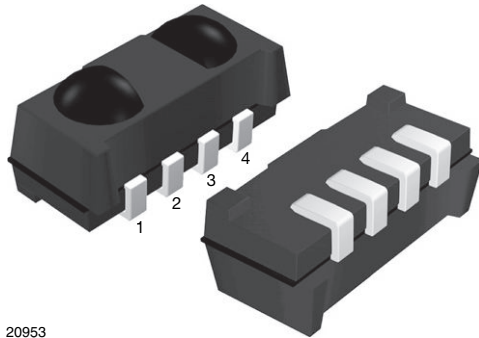

20953

## DESIGN SUPPORT TOOLS AVAILABLE



## MECHANICAL DATA

### Pinning:

 1, 4 = GND, 2 =  $V_S$ , 3 = OUT

## ORDERING CODE

### Taping:

TSSP950..TT - top view taped

TSSP950..TR - side view taped

## FEATURES

- Up to 2 m for presence and proximity sensing
- Uses continuous AC signal or burst pattern of infrared light
- PIN diode and sensor IC in one package
- Low supply current
- Shielding against EMI
- Visible light is suppressed by IR filter
- Insensitive to supply voltage ripple and noise
- Supply voltage: 2.0 V to 3.6 V
- Material categorization: for definitions of compliance please see [www.vishay.com/doc?99912](http://www.vishay.com/doc?99912)



## DESCRIPTION

The TSSP950.. series are compact infrared detector modules for presence, proximity, or light curtain applications. They provide an active low output in response to infrared bursts at 940 nm. The frequency of the burst should correspond to the carrier frequency shown in the parts table.

This component has not been qualified according to automotive specifications.

## APPLICATIONS

- Reflective sensors for hand dryers, towel or soap dispensers, water faucets, toilet flush
- Vending machine fall detection
- Security and pet gates
- Person or object vicinity activation
- Fast proximity sensors for toys, robotics, drones, and other consumer and industrial uses

| PARTS TABLE       |  |           |
|-------------------|--|-----------|
| Carrier frequency | 38 kHz                                   | TSSP95038 |
|                   | 56 kHz                                   | TSSP95056 |
| Package           | Heimdall                                 |           |
| Pinning           | 1, 4 = GND, 2 = $V_S$ , 3 = OUT          |           |
| Dimensions (mm)   | 6.8 W x 3.0 H x 3.2 D                    |           |
| Mounting          | SMD                                      |           |
| Application       | Presence sensors, fast proximity sensors |           |

## BLOCK DIAGRAM

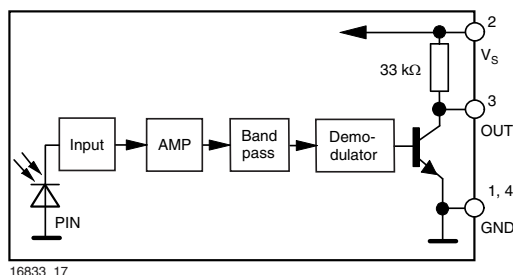

16833\_17

## PRESENCE SENSING

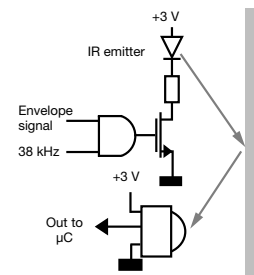



| ABSOLUTE MAXIMUM RATINGS    |                             |           |              |      |
|-----------------------------|-----------------------------|-----------|--------------|------|
| PARAMETER                   | TEST CONDITION              | SYMBOL    | VALUE        | UNIT |
| Supply voltage              |                             | $V_S$     | -0.3 to +3.6 | V    |
| Supply current              |                             | $I_S$     | 5            | mA   |
| Output voltage              |                             | $V_O$     | -0.3 to +3.6 | V    |
| Output current              |                             | $I_O$     | 5            | mA   |
| Junction temperature        |                             | $T_j$     | 100          | °C   |
| Storage temperature range   |                             | $T_{stg}$ | -25 to +85   | °C   |
| Operating temperature range |                             | $T_{amb}$ | -25 to +85   | °C   |
| Power consumption           | $T_{amb} \leq 85\text{ °C}$ | $P_{tot}$ | 10           | mW   |

**Note**

- Stresses beyond those listed under “Absolute Maximum Ratings” may cause permanent damage to the device. This is a stress rating only and functional operation of the device at these or any other conditions beyond those indicated in the operational sections of this specification is not implied. Exposure to absolute maximum rating conditions for extended periods may affect the device reliability

| ELECTRICAL AND OPTICAL CHARACTERISTICS ( $T_{amb} = 25\text{ °C}$ , unless otherwise specified) |  |                   |      |          |      |                 |
|---|--|-------------------|------|----------|------|-----------------|
| PARAMETER   | TEST CONDITION   | SYMBOL            | MIN. | TYP.     | MAX. | UNIT            |
| Supply voltage  |  | $V_S$             | 2.0  | -        | 3.6  | V               |
| Supply current  | $V_S = 5\text{ V}, E_v = 0$  | $I_{SD}$          | 0.25 | 0.37     | 0.45 | mA              |
|   | $E_v = 40\text{ klx}$ , sunlight   | $I_{SH}$          | -    | 0.8      | -    | mA              |
| Transmission distance   | $E_v = 0$ ,<br>IR diode TSAL6200,<br>$I_F = 50\text{ mA}$ ,<br>test signal see Fig. 1            | $d$               | -    | 8        | -    | m               |
| Output voltage low  | $I_{OSL} = 0.5\text{ mA}$ , $E_e = 0.7\text{ mW/m}^2$ ,<br>test signal see Fig. 1                | $V_{OSL}$         | -    | -        | 100  | mV              |
| Minimum irradiance  | Pulse width tolerance:<br>$t_{pi} - 5/f_o < t_{po} < t_{pi} + 6/f_o$ ,<br>test signal see Fig. 1 | $E_e\text{ min.}$ | -    | 0.7      | 1.2  | $\text{mW/m}^2$ |
| Maximum irradiance  | $t_{pi} - 5/f_o < t_{po} < t_{pi} + 6/f_o$ ,<br>test signal see Fig. 1                           | $E_e\text{ max.}$ | 30   | -        | -    | $\text{W/m}^2$  |
| Directivity   | Angle of half<br>transmission distance   | $\Phi_{1/2}$      | -    | $\pm 50$ | -    | °               |

**TYPICAL CHARACTERISTICS** ( $T_{amb} = 25\text{ }^{\circ}\text{C}$ , unless otherwise specified)

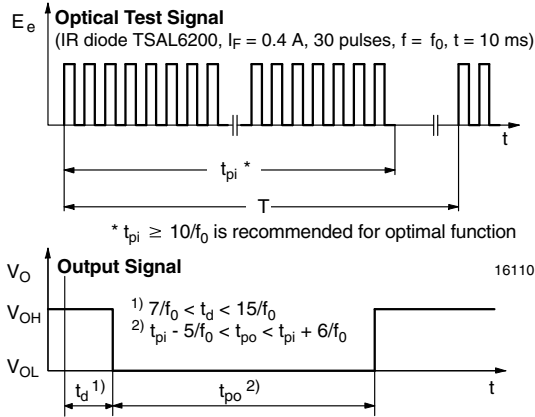

Fig. 1 - Output Active Low

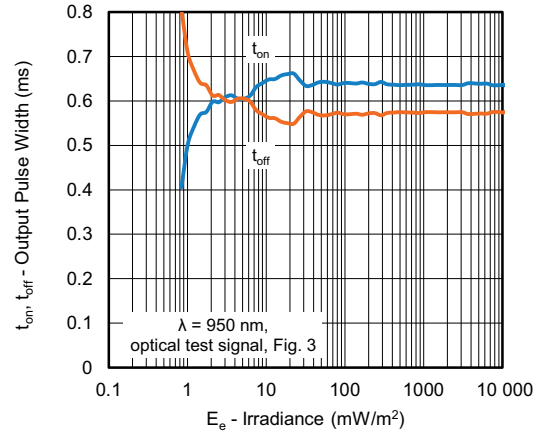

Fig. 4 - Output Pulse Diagram

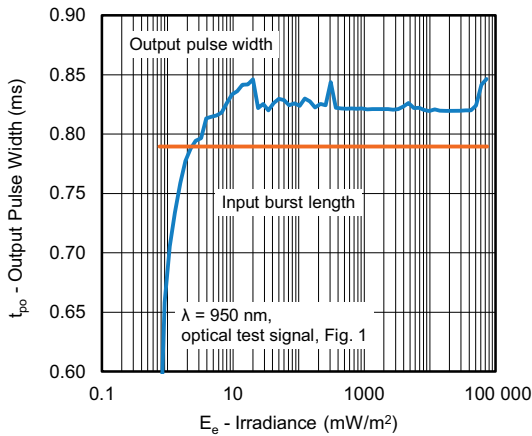

Fig. 2 - Pulse Length and Sensitivity in Dark Ambient

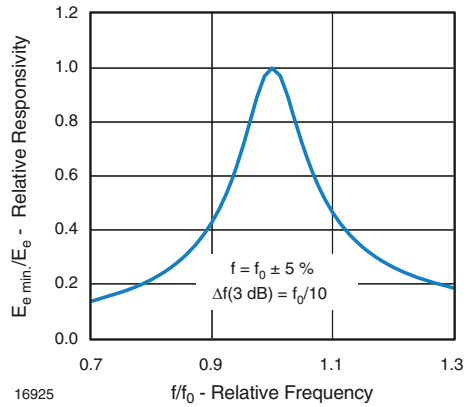

Fig. 5 - Frequency Dependence of Responsivity

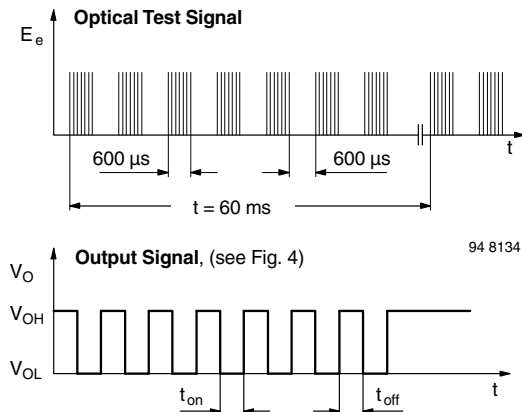

Fig. 3 - Output Function

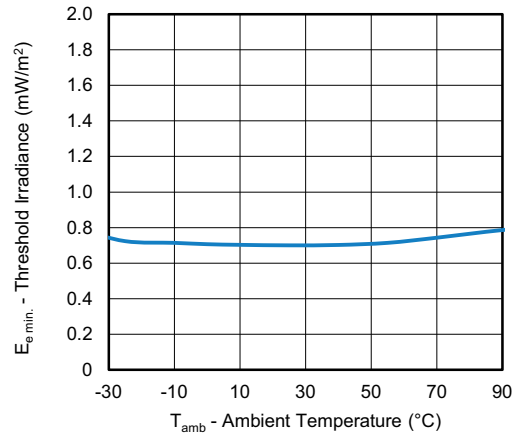
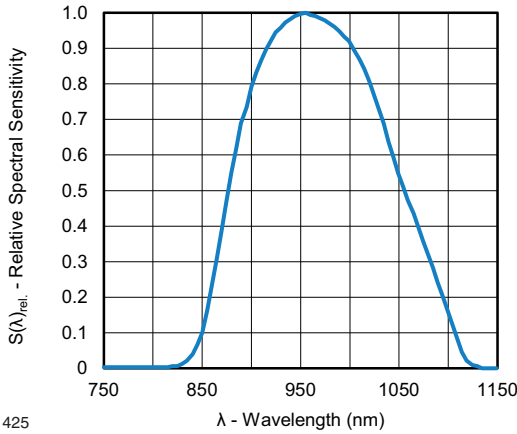
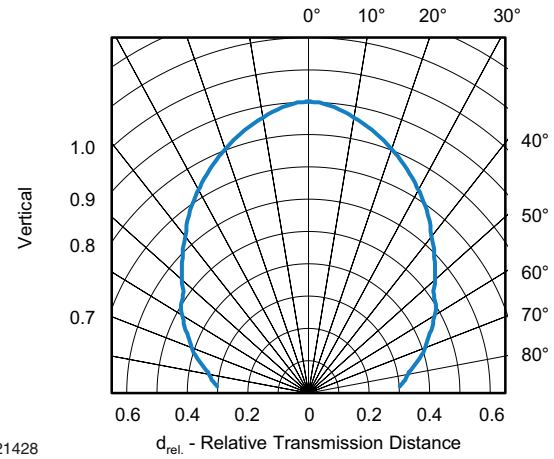

Fig. 6 - Sensitivity vs. Ambient Temperature



21425

Fig. 7 - Relative Spectral Sensitivity vs. Wavelength



21428

Fig. 9 - Vertical Directivity



21427

Fig. 8 - Horizontal Directivity

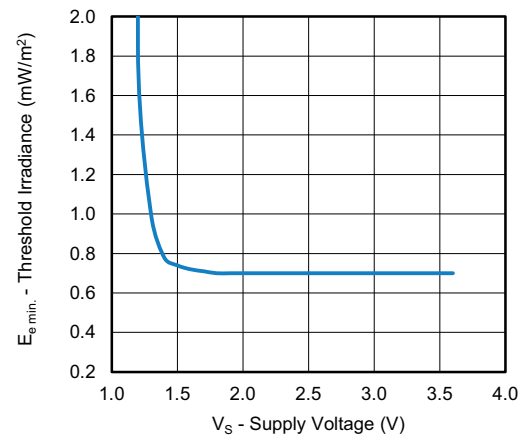

Fig. 10 - Sensitivity vs. Supply Voltage

The typical application of these devices is a reflective or beam break sensor with active low “detect” or “no detect” information contained in its output. The TSSP950.. is also suitable for fast (~ 15 ms) proximity sensor applications for ranges between 10 cm and 2 m, if a burst pattern with variable intensity is used.

Example for a sensor hardware:

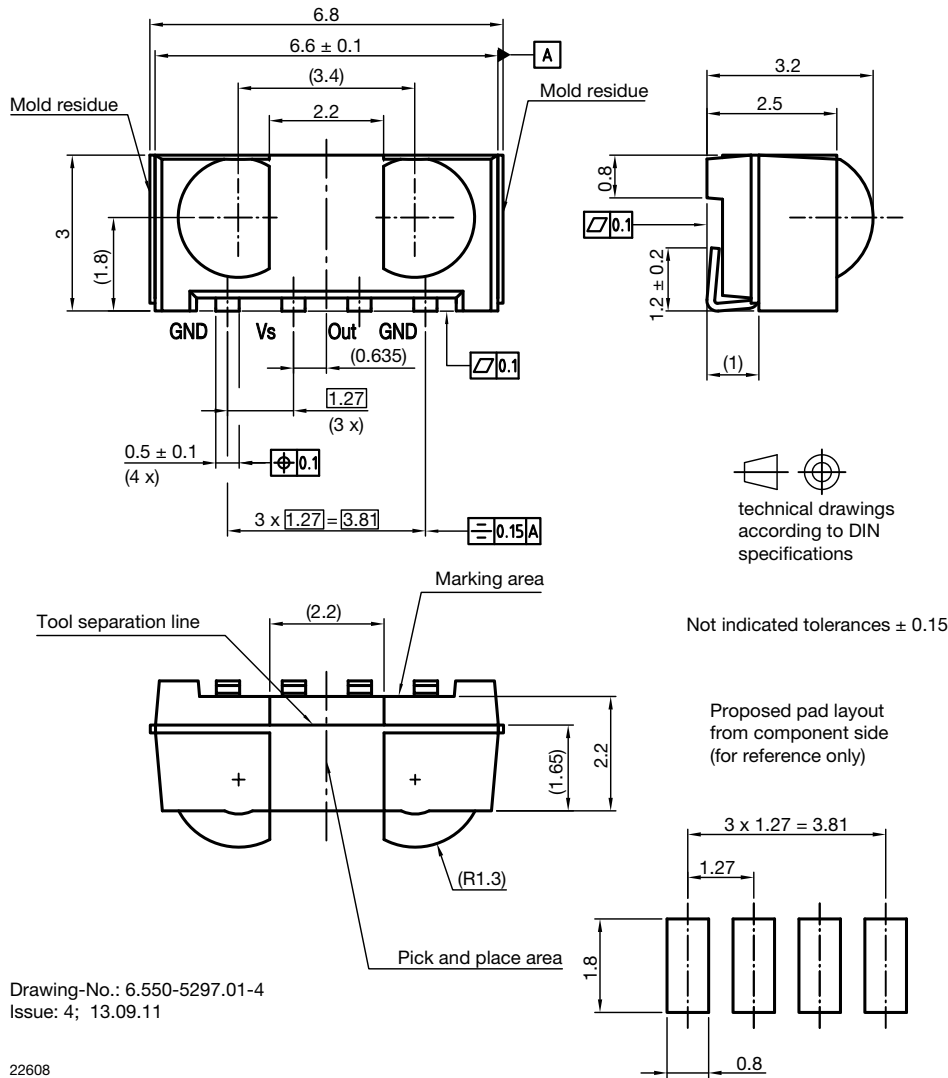

There should be no common window in front of the emitter and detector in order to avoid crosstalk via guided light through the window.

**PACKAGE DIMENSIONS** in millimeters

Drawing-No.: 6.550-5297.01-4  
 Issue: 4; 13.09.11

22608

**ASSEMBLY INSTRUCTIONS**
**Reflow Soldering**

- Reflow soldering must be done within 72 h while stored under a max. temperature of 30 °C, 60 % RH after opening the dry pack envelope
- Set the furnace temperatures for pre-heating and heating in accordance with the reflow temperature profile as shown in the diagram. Exercise extreme care to keep the maximum temperature below 260 °C. The temperature shown in the profile means the temperature at the device surface. Since there is a temperature difference between the component and the circuit board, it should be verified that the temperature of the device is accurately being measured
- Handling after reflow should be done only after the work surface has been cooled off

**Manual Soldering**

- Use a soldering iron of 25 W or less. Adjust the temperature of the soldering iron below 300 °C
- Finish soldering within 3 s
- Handle products only after the temperature has cooled off

**VISHAY LEAD (Pb)-FREE REFLOW SOLDER PROFILE**

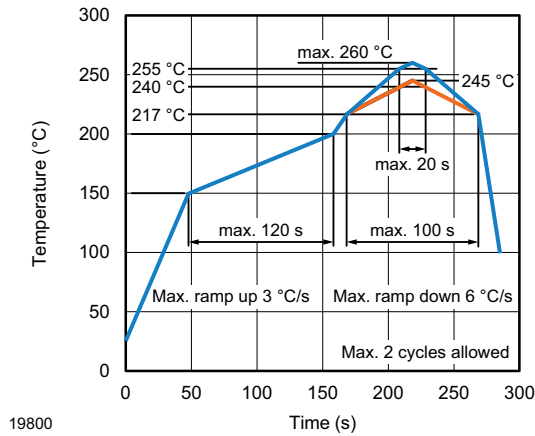

**TAPING VERSION TSSP..TR DIMENSIONS in millimeters**



Drawing-No.: 9.700-5337.01-4  
Issue: 2; 06.10.15

technical drawings according to DIN specifications



**TAPING VERSION TSSP..TT DIMENSIONS** in millimeters

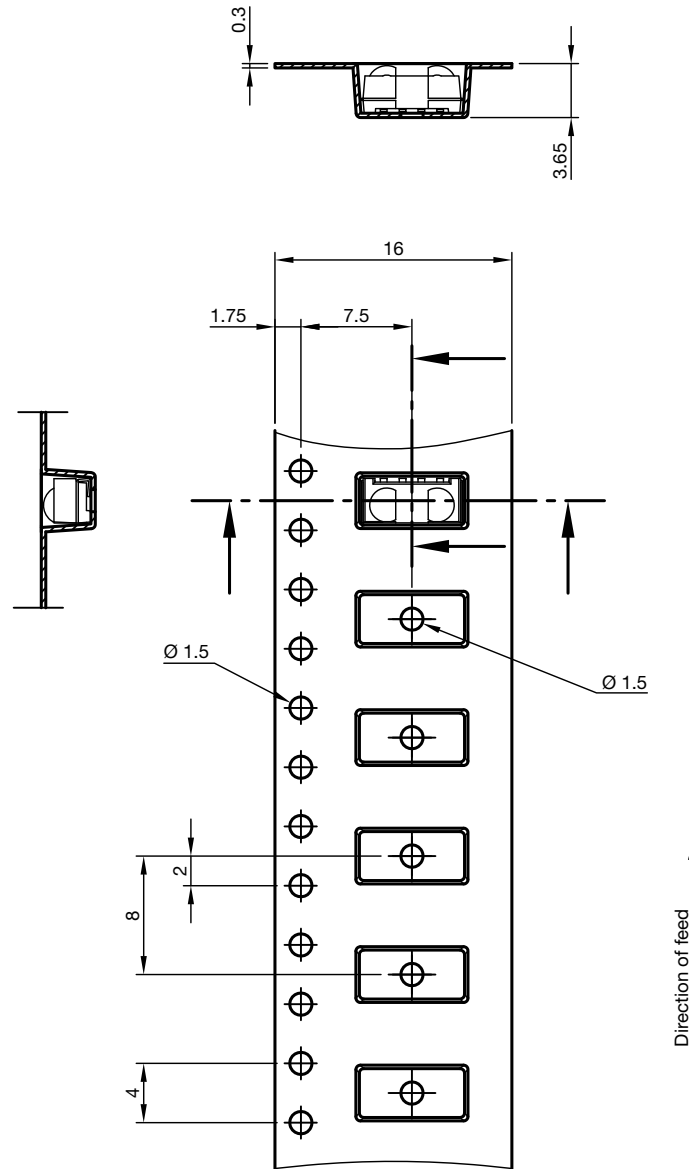

Drawing-No.: 9.700-5338.01-4  
Issue: 4; 12.06.13

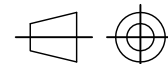

technical drawings  
according to DIN  
specifications

**REEL DIMENSIONS** in millimeters



Form of the leave open of the wheel is supplier specific.

Dimension acc. to IEC EN 60 286-3

Tape width 16

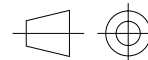

technical drawings according to DIN specifications

Drawing-No.: 9.800-5052.V2-4

Issue: 1; 07.05.02

16734

**LEADER AND TRAILER DIMENSIONS** in millimeters

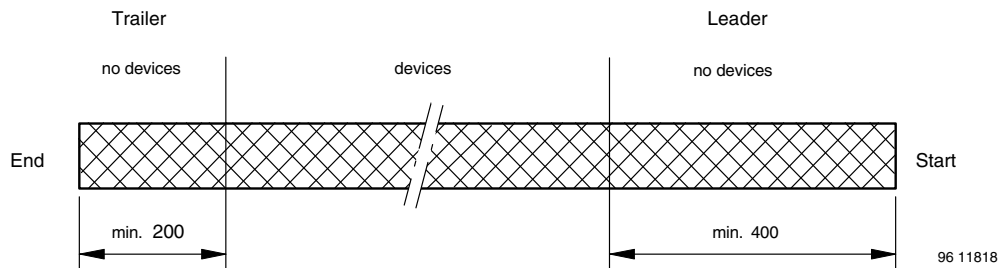

**COVER TAPE REEL STRENGTH**

According to DIN EN 60286-3

0.1 N to 1.3 N

300 ± 10 mm/min.

165° to 180° peel angle

**LABEL**

**Standard bar code labels for finished goods**

The standard bar code labels are product labels and used for identification of goods. The finished goods are packed in final packing area. The standard packing units are labeled with standard bar code labels before transported as finished goods to warehouses. The labels are on each packing unit and contain Vishay Semiconductor GmbH specific data.



| <b>VISHAY SEMICONDUCTORS GmbH STANDARD BAR CODE PRODUCT LABEL (finished goods)</b> |                     |               |
|--|---------------------|---------------|
| <b>PLAIN WRITING</b>   | <b>ABBREVIATION</b> | <b>LENGTH</b> |
| Item-description   | -                   | 18            |
| Item-number  | INO                 | 8             |
| Selection-code   | SEL                 | 3             |
| LOT-/serial-number   | BATCH               | 10            |
| Data-code  | COD                 | 3 (YWW)       |
| Plant-code   | PTC                 | 2             |
| Quantity   | QTY                 | 8             |
| Accepted by  | ACC                 | -             |
| Packed by  | PCK                 | -             |
| Mixed code indicator   | MIXED CODE          | -             |
| Origin   | xxxxxxx+            | Company logo  |
| <b>LONG BAR CODE TOP</b>   | <b>TYPE</b>         | <b>LENGTH</b> |
| Item-number  | N                   | 8             |
| Plant-code   | N                   | 2             |
| Sequence-number  | X                   | 3             |
| Quantity   | N                   | 8             |
| Total length   | -                   | 21            |
| <b>SHORT BAR CODE BOTTOM</b>   | <b>TYPE</b>         | <b>LENGTH</b> |
| Selection-code   | X                   | 3             |
| Data-code  | N                   | 3             |
| Batch-number   | X                   | 10            |
| Filter   | -                   | 1             |
| Total length   | -                   | 17            |

### DRY PACKING

The reel is packed in an anti-humidity bag to protect the devices from absorbing moisture during transportation and storage.

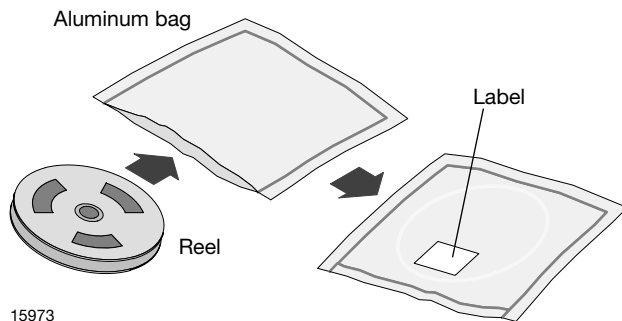

### FINAL PACKING

The sealed reel is packed into a cardboard box.

### RECOMMENDED METHOD OF STORAGE

Dry box storage is recommended as soon as the aluminum bag has been opened to prevent moisture absorption. The following conditions should be observed, if dry boxes are not available:

- Storage temperature 10 °C to 30 °C
- Storage humidity ≤ 60 % RH max.

After more than 72 h under these conditions moisture content will be too high for reflow soldering.

In case of moisture absorption, the devices will recover to the former condition by drying under the following condition:  
 192 h at 40 °C + 5 °C / - 0 °C and < 5 % RH (dry air / nitrogen) or  
 96 h at 60 °C + 5 °C and < 5 % RH for all device containers or  
 24 h at 125 °C + 5 °C not suitable for reel or tubes.

An EIA JEDEC® standard J-STD-020 level 4 label is included on all dry bags.

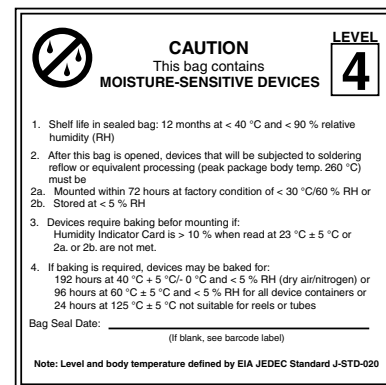

EIA JEDEC standard J-STD-020 level 4 label is included on all dry bags



**ESD PRECAUTION**

Proper storage and handling procedures should be followed to prevent ESD damage to the devices especially when they are removed from the antistatic shielding bag. Electrostatic sensitive devices warning labels are on the packaging.

**VISHAY SEMICONDUCTORS STANDARD BAR CODE LABELS (example)**

The Vishay Semiconductors standard bar code labels are printed at final packing areas. The labels are on each packing unit and contain Vishay Semiconductors specific data.

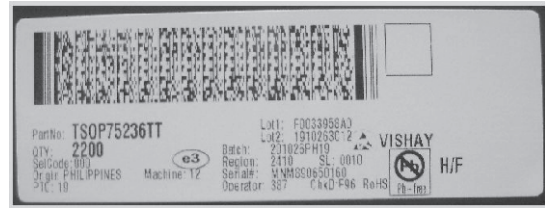

22178



## **Disclaimer**

ALL PRODUCT, PRODUCT SPECIFICATIONS AND DATA ARE SUBJECT TO CHANGE WITHOUT NOTICE TO IMPROVE RELIABILITY, FUNCTION OR DESIGN OR OTHERWISE.

Vishay Intertechnology, Inc., its affiliates, agents, and employees, and all persons acting on its or their behalf (collectively, "Vishay"), disclaim any and all liability for any errors, inaccuracies or incompleteness contained in any datasheet or in any other disclosure relating to any product.

Vishay makes no warranty, representation or guarantee regarding the suitability of the products for any particular purpose or the continuing production of any product. To the maximum extent permitted by applicable law, Vishay disclaims (i) any and all liability arising out of the application or use of any product, (ii) any and all liability, including without limitation special, consequential or incidental damages, and (iii) any and all implied warranties, including warranties of fitness for particular purpose, non-infringement and merchantability.

Statements regarding the suitability of products for certain types of applications are based on Vishay's knowledge of typical requirements that are often placed on Vishay products in generic applications. Such statements are not binding statements about the suitability of products for a particular application. It is the customer's responsibility to validate that a particular product with the properties described in the product specification is suitable for use in a particular application. Parameters provided in datasheets and / or specifications may vary in different applications and performance may vary over time. All operating parameters, including typical parameters, must be validated for each customer application by the customer's technical experts. Product specifications do not expand or otherwise modify Vishay's terms and conditions of purchase, including but not limited to the warranty expressed therein.

Except as expressly indicated in writing, Vishay products are not designed for use in medical, life-saving, or life-sustaining applications or for any other application in which the failure of the Vishay product could result in personal injury or death. Customers using or selling Vishay products not expressly indicated for use in such applications do so at their own risk. Please contact authorized Vishay personnel to obtain written terms and conditions regarding products designed for such applications.

No license, express or implied, by estoppel or otherwise, to any intellectual property rights is granted by this document or by any conduct of Vishay. Product names and markings noted herein may be trademarks of their respective owners.