

SK225xD Series

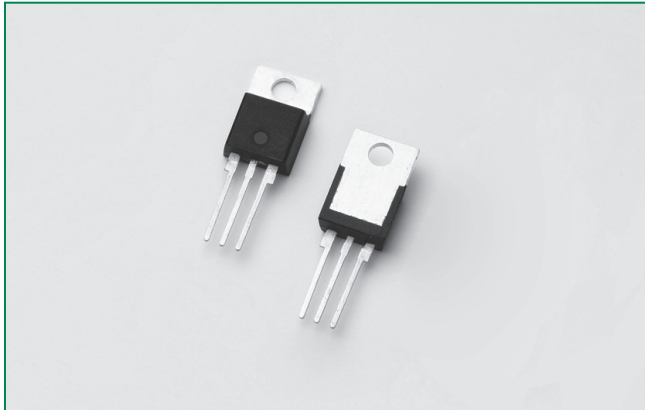

**Description**

Excellent unidirectional switches for phase control applications such as heating and motor speed controls. Standard phase control SCRs are triggered with few milliamperes of current at less than 1.5V potential.

**Features & Benefits**

- RoHS compliant
- Voltage capability up to 1200 V
- Surge capability up to 300 A
- Electrically isolated package "LD-Package" and UL recognized for 2500V<sub>RMS</sub>

**Applications**

Typical applications are AC solid-state switches, industrial power tools, line rectification 50/60Hz. Internally constructed isolated packages are offered for ease of heat sinking with highest isolation voltage.

**Agency Approval**

Agency	Agency File Number
	E71639

**Main Features**

Symbol	Value	Unit
$I_{T(RMS)}$	25	A
$V_{DRM}/V_{RRM}$	1200	V
$I_{GT}$	40	mA

**Schematic Symbol**

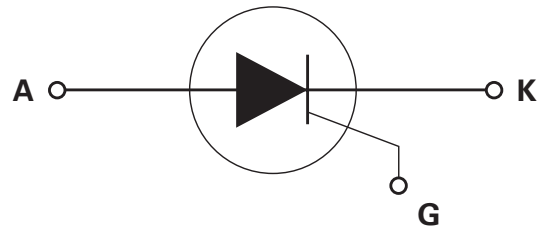

**Absolute Maximum Ratings – 25A SCR**

Symbol	Parameter	Test Conditions		Value	Unit
$V_{DRM} / V_{RRM}$	Repetitive Peak off-state/Reverse Voltage			1200	V
$V_{DSM} / V_{RSM}$	Non-repetitive peak off-state/Reverse voltage			1300	V
$I_{T(RMS)}$	RMS on-state current	SK225LD	$T_c = 75^\circ\text{C}$	25	A
		SK225RD	$T_c = 95^\circ\text{C}$		
$I_{T(AV)}$	Average on-state current	SK225LD	$T_c = 75^\circ\text{C}$	16	A
		SK225RD	$T_c = 95^\circ\text{C}$		
$I_{TSM}$	Peak non-repetitive surge current	single half cycle; $f = 50\text{Hz}$ ; $T_J$ (initial) = $25^\circ\text{C}$		300	A
		single half cycle; $f = 60\text{Hz}$ ; $T_J$ (initial) = $25^\circ\text{C}$		360	
$I^2t$	$I^2t$ Value for fusing	$t_p = 8.3 \text{ ms}$		540	$\text{A}^2\text{s}$
$di/dt$	Critical rate of rise of on-state current			50	$\text{A}/\mu\text{s}$
$I_{GM}$	Peak gate current	$T_J = 125^\circ\text{C}$		3	A
$P_{G(AV)}$	Average gate power dissipation	$T_J = 125^\circ\text{C}$		1	W
$T_{stg}$	Storage temperature range			-40 to 150	$^\circ\text{C}$
$T_J$	Operating junction temperature range			-40 to 125	$^\circ\text{C}$

Notes :  
 x = package

**Electrical Characteristics ( $T_J = 25^\circ\text{C}$ , unless otherwise specified)**

Symbol	Test Conditions	Value	Unit
$I_{GT}$	$V_D = 12\text{V}; R_L = 30\Omega$	MAX.	40
$V_{GT}$		MAX.	1.5
$dv/dt$	$V_D = 2/3 V_{DRM}$ ; gate open; $T_J = 125^\circ\text{C}$	MIN.	1000
$V_{GD}$	$V_D = V_{DRM}$ ; $R_L = 3.3 \text{ k}\Omega$ ; $T_J = 125^\circ\text{C}$	MIN.	0.2
$I_H$	$I_T = 500\text{mA}$ (initial)	MAX.	100
$t_q$	$I_T = 0.5\text{A}$ ; $t_p = 50\mu\text{s}$ ; $dv/dt = 5\text{V}/\mu\text{s}$ ; $di/dt = -30\text{A}/\mu\text{s}$	TYP.	15
$t_{gt}$	$I_G = 2 \times I_{GT}$ ; $PW = 15\mu\text{s}$ ; $I_T = 50\text{A}$	TYP.	3

Notes :  
 x = package

**Static Characteristics**

Symbol	Test Conditions	Value	Unit	
$V_{TM}$	$I_T = 50\text{A}$ ; $t_p = 380\mu\text{s}$	MAX.	1.6	
$I_{DRM} / I_{RRM}$	$V_{DRM} / V_{RRM}$	$T_J = 25^\circ\text{C}$	MAX.	10
		$T_J = 125^\circ\text{C}$	MAX.	4

**Thermal Resistances**

Symbol	Parameter	Value	Unit
$R_{\theta(J-C)}$	Junction to case (AC)	SK225RD	1.0
		SK225LD	1.9

**Figure 1: Normalized DC Gate Trigger Current vs. Junction Temperature**

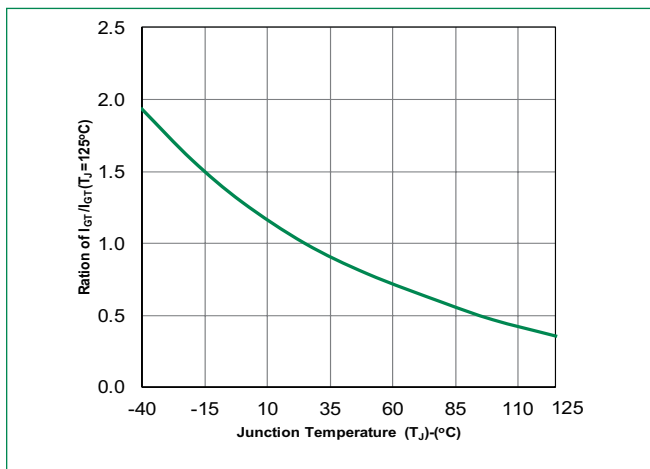

**Figure 2: Normalized DC Gate Trigger Voltage vs. Junction Temperature**

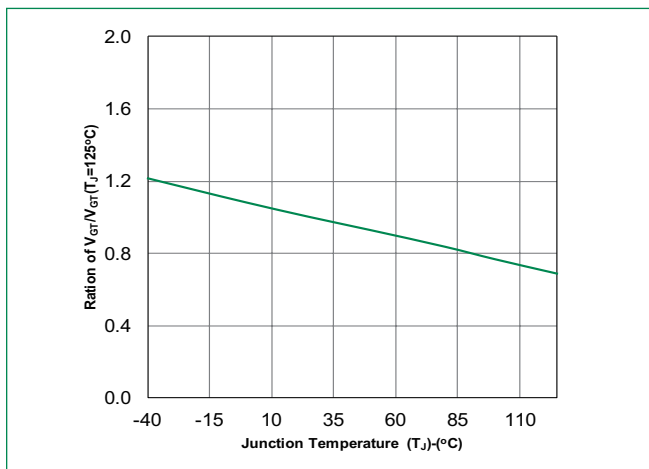

**Figure 3: Normalized DC Holding Current vs. Junction Temperature**

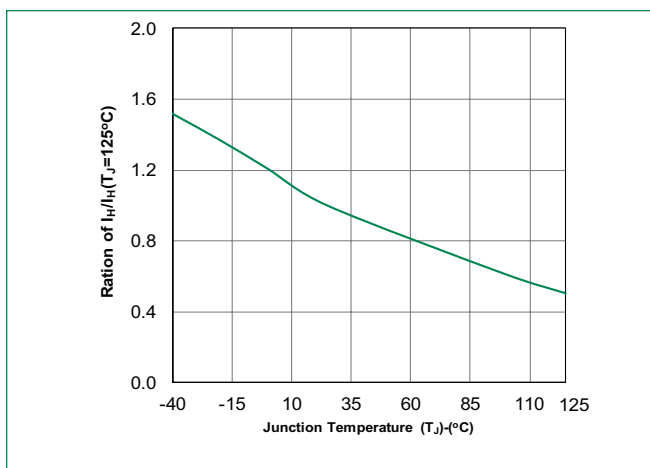

**Figure 4: On-State Current vs. On-State Voltage (Typical)**

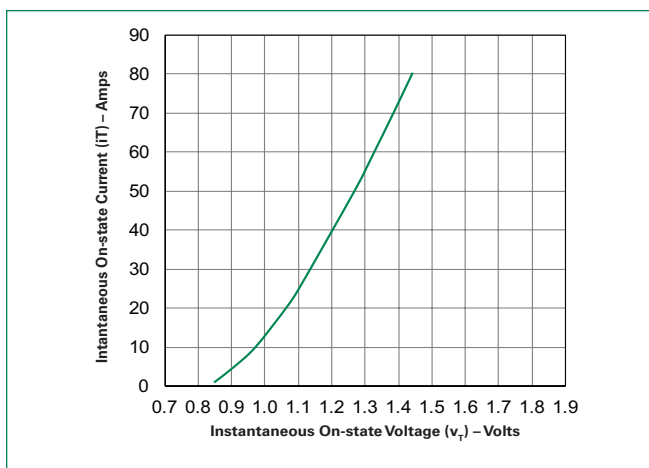

**Figure 5: Power Dissipation (Typical) vs. RMS On-State Current**

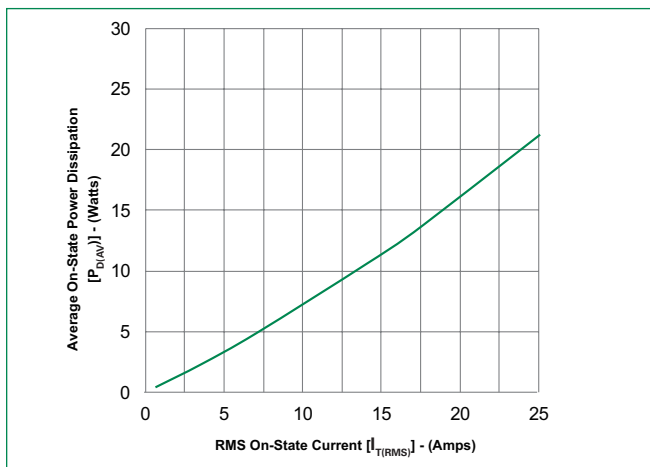

**Figure 6: Maximum Allowable Case Temperature vs. RMS On-State Current**

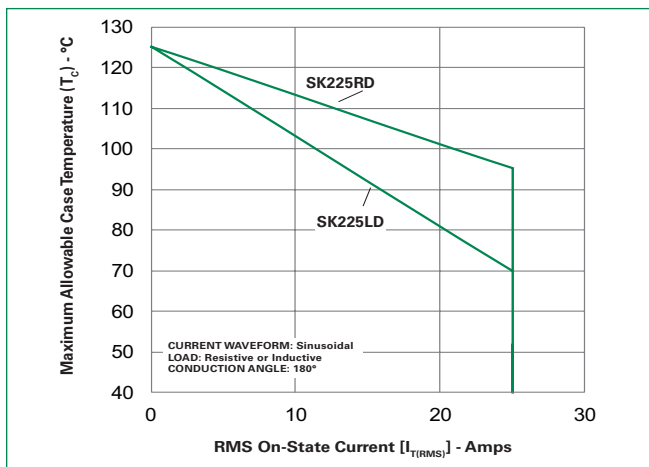

**Figure 7: Maximum Allowable Case Temperature vs. Average On-State Current**

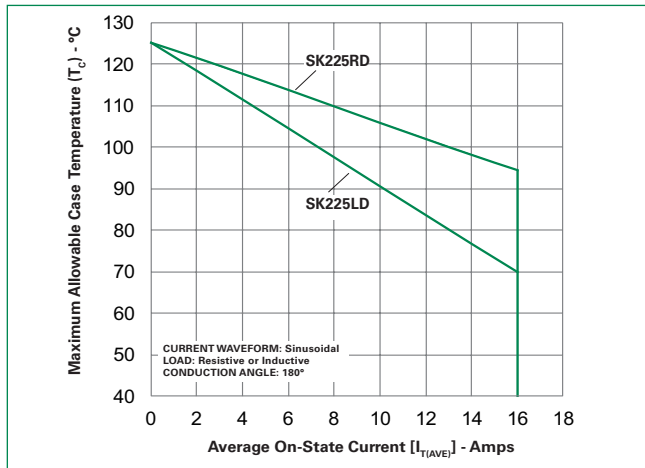

**Figure 8: Surge Peak On-State Current vs. Number of Cycles**

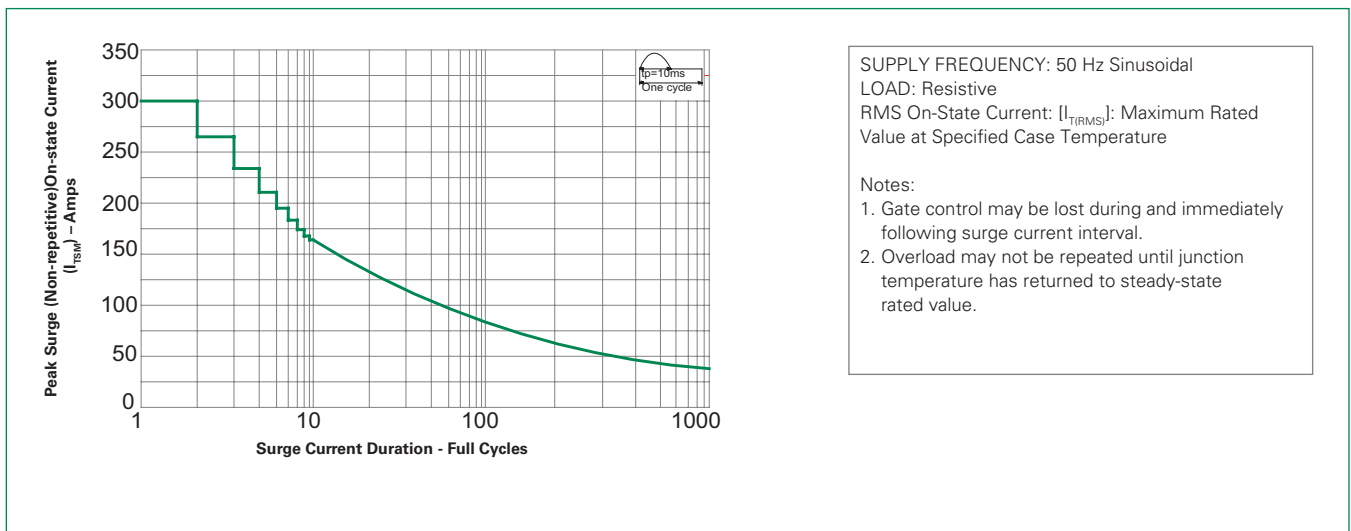

**Environmental Specifications**

Test	Specifications and Conditions
<b>AC Blocking</b>	JESD22-A108C, 80% $V_{DRM}$ @125°C for 168 hours
<b>Temperature Cycling</b>	MIL-STD-750, M-1051, 100 cycles; -40°C to +150°C; 15-min dwell-time
<b>Temperature/Humidity</b>	EIA / JEDEC, JESD22-A101 168 hours; 100V - DC: 85°C; 85% rel humidity
<b>Resistance to Solder Heat</b>	JESD22-B106C
<b>Solderability</b>	J-STD-022, category 3, test A

**Design Considerations**

Careful selection of the correct device for the application's operating parameters and environment will go a long way toward extending the operating life of the Thyristor. Good design practice should limit the maximum continuous current through the main terminals to 75% of the device rating. Other ways to ensure long life for a power discrete semiconductor are proper heat sinking and selection of voltage ratings for worst case conditions. Overheating, overvoltage (including  $dv/dt$ ), and surge currents are the main killers of semiconductors. Correct mounting, soldering, and forming of the leads also help protect against component damage.

**Dimensions — TO-220AB (RD-Package) — Non-Isolated Mounting Tab Common with Center Lead**

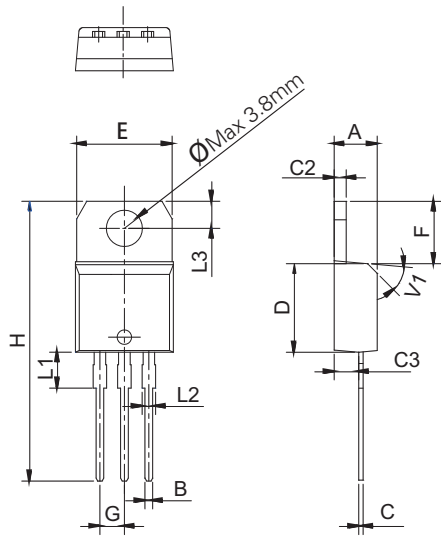

Note: Maximum torque to be applied to mounting tab is 3 in-lbs (0.3Nm).

Dimension	Millimeters			Inches		
	Min.	Typ.	Max.	Min.	Typ.	Max.
A	4.40		4.60	0.173		0.181
B	0.61		0.88	0.024		0.035
C	0.46		0.70	0.018		0.028
C2	1.21		1.32	0.048		0.052
C3	2.40		2.72	0.094		0.107
D	8.60		9.70	0.339		0.382
E	9.60		10.4	0.378		0.409
F	6.20		6.60	0.244		0.260
G		2.54			0.1	
H	28.0		29.8	1.102		1.173
L1		3.75			0.148	
L2	1.14		1.70	0.045		0.067
L3	2.65		2.95	0.104		0.116
V1		45°			45°	

**Dimensions — TO-220AB (LD-Package) — Isolated Mounting Tab**

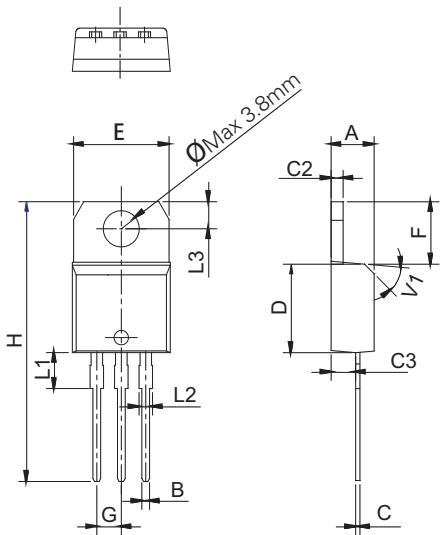

Note: Maximum torque to be applied to mounting tab is 7 in-lbs. (0.8 Nm).

Dimension	Millimeters			Inches		
	Min.	Typ.	Max.	Min.	Typ.	Max.
A	4.40		4.60	0.173		0.181
B	0.61		0.88	0.024		0.035
C	0.46		0.70	0.018		0.028
C2	1.21		1.32	0.048		0.052
C3	2.40		2.72	0.094		0.107
D	8.60		9.70	0.339		0.382
E	9.80		10.4	0.386		0.409
F	6.55		6.95	0.258		0.274
G		2.54			0.1	
H	28.0		29.8	1.102		1.173
L1		3.75			0.148	
L2	1.14		1.70	0.045		0.067
L3	2.65		2.95	0.104		0.116
V1		45°			45°	

**Product Selector**

Part Number	Gate Sensitivity	Type	Package
SK225LD	40mA	Standard SCR	TO-220L
SK225RD	40mA	Standard SCR	TO-220R

**Packing Options**

Part Number	Marking	Weight	Packing Mode	Base Quantity
SK225LDTP	SK225LD	2.2g	Tube	1000
SK225RDTP	SK225RD	2.0g	Tube	1000

**Part Numbering System**

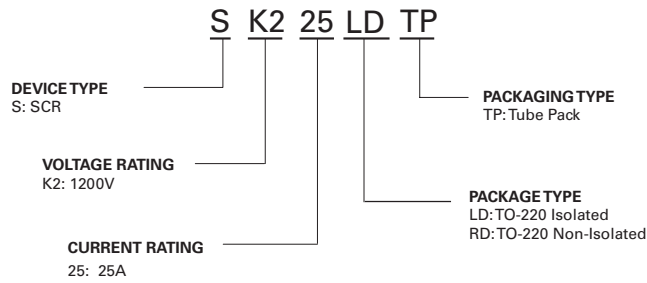

**Part Marking System**

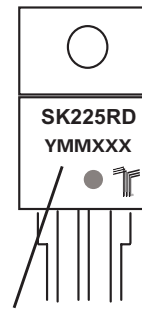

**Date Code Marking**  
 Y: Year Code  
 MM: Month Code  
 XXX: Lot Trace Code