

MOMENTARY ACTION, SEALED SUB-SUBMINIATURE PUSHBUTTON SNAP-ACTION SWITCHES

The P7 series incorporates OTTO's patented double break design in a significantly smaller package than the P1 series. These subminiature switches embrace today's technology requirements by allowing for a large number of switches to fit within a faceplate.

The long life snap-action design is protected from the environment by a silicon rubber boot, operating on a patented "rolling sleeve" principle that gives long sealed life and smooth operation.

The P7 series is designed to meet the requirements of MIL-PRF-8805 including low level switching (10mA @ 30mV) with power switching up to 5 amps at 28VDC as well.

A variety of mounting styles are offered to best match the application. The P7-1, P7-2, P7-7 and P7-8 case styles feature a swaged bushing shape to allow press fit installation in aircraft flight control and hand grips and similar applications. The other styles feature threaded bushing mounting. The P7-3 case style has a front panel bezel, while the P7-5 and P7-6 have conventional bushings for rear panel mounted installations. Silver or black bezels are standard. Other colors available on special order.

Pushbuttons are available in a choice of nine colors. Excellent tactile feedback assures the operator that contact transfer has been made.

A choice of MIL-SPEC and commercial versions of these switches are offered: Moistureproof and dusttight to IP64 and MIL-PRF-8805 Design 2 or watertight to IP68S and to MIL-PRF-8805 Design 3.

Features:

- **Low level switching capability**
- **Less than 25mΩ contact resistance**
- **High contact pressure**
- **6 circuit variations**
- **Positive tactile feedback**
- **Variety of mounting styles**
- **Qualified to MIL-PRF-8805/110**
- **Moistureproof & dusttight to IP64 & MIL-PRF-8805 Design 2 or watertight to IP68S & MIL-PRF-8805 Design 3**
- **RoHS/WEEE/Reach compliant**



Standard Characteristics/Ratings:							
ELECTRICAL RATINGS:		Sea Level @ 28VDC			50,000 feet @ 28VDC		
Load	Circuits:	1 & 2	3-5	6	1 & 2	3-5	6
Resistive		5A	2.5A	4A	5A	2.5A	4A
Inductive		3A	1.5A	2A	3A	1.5A	2A
Lamp		1A	0.5A	N/A	N/A	N/A	N/A
Motor		3A	1.5A	N/A	N/A	N/A	N/A
DWV		1050Vrms			400Vrms		
Center Contact		3A max					
Low Level		10mA @ 30mV					
Electrical Life:		25,000 cycles					
Mechanical Life:		1,000,000 cycles					
Seal:		IP64 and MIL-PRF-8805 Design 2 or IP68S and MIL-PRF-8805 Design 3					
Operating Temp Range:		-55°C to +85°C					
Operating Force:		1.7 +/- 0.5 lb.					
Total Travel:		0.080 inches max					
Overtravel:		0.010 inches min					
MATERIALS:							
Case:		Anodized aluminum alloy					
Button:		Thermoplastic					
Terminals:		Brass with gold over silver					
Terminal Hardware:		None provided					
Mounting Hardware:		Hex nut, lockwasher and panel gasket when applicable					

SEALED AGAINST DUST & MOISTURE, LOW LEVEL SWITCHING OPTION

<p>P7-1 Series</p> <p>Case Style 1 Press Fit Mount</p> <p>Also available with PC terminals.</p>		<p>P7-6 Series</p> <p>Case Style 6 15/32" Threaded Bushing</p> <p>Also available with PC pins.</p>																																																																									
<p>P7-2 Series</p> <p>Case Style 2 Press Fit Mount</p> <p>Also available with PC pins.</p>		<p>P7-7 Series</p> <p>Case Style 7 Press Fit Mount</p> <p>Also available with PC pins.</p>																																																																									
<p>P7-3 Series</p> <p>Case Style 3 Bezel/Threaded Bushing</p> <p>Also available with PC pins.</p>		<p>P7-8 Series</p> <p>Case Style 8 Press Fit Mount Guarded Button</p> <p>Also available with PC pins.</p>																																																																									
<p>P7-5 Series</p> <p>Case Style 5 1/4" Threaded Bushing</p> <p>Also available with PC pins.</p>		<p>Terminal Style "A" & "B"</p> <p>Standard</p>																																																																									
<p>PC Pin Mounting Pattern</p> <p>(As viewed from switch bottom. See above drawings for terminal identification.)</p>	<p align="center">P7 PART NUMBER CODE</p> <p align="center">P7 - X X X X X X</p> <table border="1"> <thead> <tr> <th>Case Style</th> <th>Terminal Style/Construction Grade</th> <th>Circuit Form</th> <th>Contact Rating</th> <th>Bezel Color/Button Dia.</th> <th>Button Color</th> </tr> </thead> <tbody> <tr> <td>1. Style 1</td> <td>A. Solder/Commercial</td> <td>1. N.O.</td> <td>1. Std.</td> <td>1. Clear/Std.</td> <td>1. Red</td> </tr> <tr> <td>2. Style 2</td> <td>B. Solder/Watertight</td> <td>2. N.C.</td> <td>2. Low Level</td> <td>2. Black/Std.</td> <td>2. Black</td> </tr> <tr> <td>3. Style 3</td> <td>Commercial</td> <td>3. N.C. 3 Terminal</td> <td></td> <td>3. Clear/0.312 Ⓢ</td> <td>3. Orange</td> </tr> <tr> <td>5. Style 5</td> <td>1. Solder/Military/Short</td> <td>4. N.O. 3 Terminal</td> <td></td> <td>4. Black/0.312 Ⓢ</td> <td>4. Yellow</td> </tr> <tr> <td>6. Style 6</td> <td>2. Solder/Commercial/Short</td> <td>5. 5 Terminal</td> <td></td> <td></td> <td>5. Green</td> </tr> <tr> <td>7. Style 7</td> <td>3. Solder/Mil. Watertight/Short</td> <td>6. 2 Circuit</td> <td></td> <td></td> <td>6. Blue</td> </tr> <tr> <td>8. Style 8</td> <td>4. PC Pin/Commercial</td> <td></td> <td></td> <td></td> <td>7. Purple</td> </tr> <tr> <td></td> <td>5. PC Pin/Military</td> <td></td> <td></td> <td></td> <td>8. Gray</td> </tr> <tr> <td></td> <td>6. PC Pin/Mil. Watertight</td> <td></td> <td></td> <td></td> <td>9. White</td> </tr> <tr> <td></td> <td>7. Solder/Com. Watertight/Short</td> <td></td> <td></td> <td></td> <td></td> </tr> <tr> <td></td> <td>8. PC Pin/Com. Watertight</td> <td></td> <td></td> <td></td> <td></td> </tr> </tbody> </table> <p>Ⓢ Not available with Case Styles 1, 2 & 5.</p>			Case Style	Terminal Style/Construction Grade	Circuit Form	Contact Rating	Bezel Color/Button Dia.	Button Color	1. Style 1	A. Solder/Commercial	1. N.O.	1. Std.	1. Clear/Std.	1. Red	2. Style 2	B. Solder/Watertight	2. N.C.	2. Low Level	2. Black/Std.	2. Black	3. Style 3	Commercial	3. N.C. 3 Terminal		3. Clear/0.312 Ⓢ	3. Orange	5. Style 5	1. Solder/Military/Short	4. N.O. 3 Terminal		4. Black/0.312 Ⓢ	4. Yellow	6. Style 6	2. Solder/Commercial/Short	5. 5 Terminal			5. Green	7. Style 7	3. Solder/Mil. Watertight/Short	6. 2 Circuit			6. Blue	8. Style 8	4. PC Pin/Commercial				7. Purple		5. PC Pin/Military				8. Gray		6. PC Pin/Mil. Watertight				9. White		7. Solder/Com. Watertight/Short						8. PC Pin/Com. Watertight				
Case Style	Terminal Style/Construction Grade	Circuit Form	Contact Rating	Bezel Color/Button Dia.	Button Color																																																																						
1. Style 1	A. Solder/Commercial	1. N.O.	1. Std.	1. Clear/Std.	1. Red																																																																						
2. Style 2	B. Solder/Watertight	2. N.C.	2. Low Level	2. Black/Std.	2. Black																																																																						
3. Style 3	Commercial	3. N.C. 3 Terminal		3. Clear/0.312 Ⓢ	3. Orange																																																																						
5. Style 5	1. Solder/Military/Short	4. N.O. 3 Terminal		4. Black/0.312 Ⓢ	4. Yellow																																																																						
6. Style 6	2. Solder/Commercial/Short	5. 5 Terminal			5. Green																																																																						
7. Style 7	3. Solder/Mil. Watertight/Short	6. 2 Circuit			6. Blue																																																																						
8. Style 8	4. PC Pin/Commercial				7. Purple																																																																						
	5. PC Pin/Military				8. Gray																																																																						
	6. PC Pin/Mil. Watertight				9. White																																																																						
	7. Solder/Com. Watertight/Short																																																																										
	8. PC Pin/Com. Watertight																																																																										

EXAMPLES OF CUSTOMIZED P7 SEALED PUSHBUTTONS



Special Longer Length Button

Panel seal gasket and watertight enclosure. Button is black nylon. Bezel is black anodized aluminum alloy.

Actuation Momentary
OTTO Part Number P7-500001

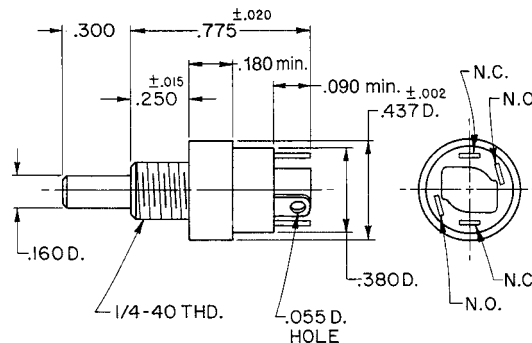

Special Large Button, Press Fit

Available with a 0.375" dia. button with three color options.

Color
Red P7-900001
Black P7-900002
White P7-900009

Contact factory for additional button color options.

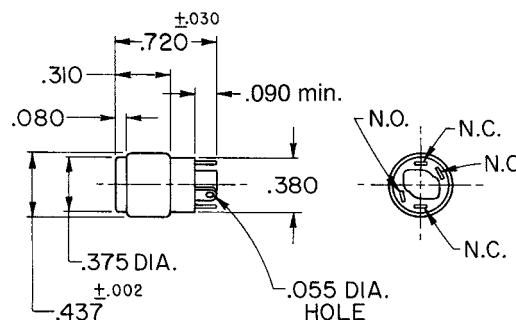

Special Snap-On Button, Wire Leads

Features changeable snap-on button caps available in two diameters and in a range of colors. Switch is splashproof sealed per MIL-PRF-8805 and is supplied with a silicone panel gasket.

Part Number: P7-500018

Button Color	0.440" Dia.	0.375" Dia.
Red	C400725-1	C400723-1
Black	C400725-2	C400723-2
Orange	C400725-3	C400723-3
White	C400725-9	C400723-9

Contact factory for additional button color options.

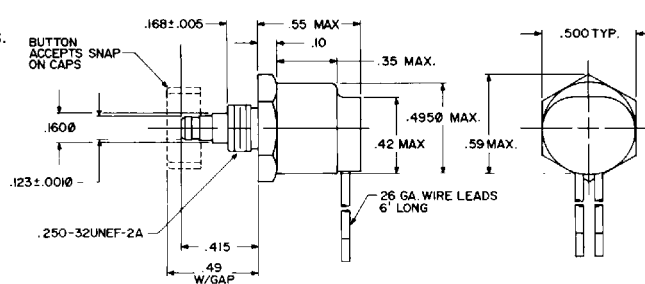

Mini Pushbutton, Shrouded

This shrouded pushbutton is designed to reduce the chance of inadvertent actuation. Button size is .19". Enclosure design is watertight per IP68S.

Actuation Momentary
OTTO Part Number P7-900196

