



Main

Accessory / separate part category	Cabling accessory
Accessory / separate part type	Pre-wired connectors
Series name	General purpose

Complementary

Electrical connection	M8, 4 pins elbowed female connector
Cable connector fixing	Screw-on
Collar material	Metal
Status LED	Without
Cable length	6.56 ft (2 m)
Cable outer diameter	0.2 in (5.2 mm)
Cable composition	4 x 0.34 mm ²
Wire insulation material	PUR
System Voltage	60 V AC 75 V DC
Line Rated Current	4 A
Contact resistance	5000 µOhm
Insulating resistance	1 GΩ
Product weight	0.18 lb(US) (0.08 kg)

Environment

IP degree of protection	IP65 IP67 IP69K
product certifications	CULus
ambient air temperature for operation	-40...176 °F (-40...80 °C) (static) 23...176 °F (-5...80 °C) (flexing)
ambient air temperature for storage	-40...176 °F (-40...80 °C)

Offer Sustainability

Green Premium product	Green Premium product
Compliant - since 0649 - Schneider Electric declaration of conformity	Compliant - since 0649 - Schneider Electric declaration of conformity
Reference not containing SVHC above the threshold	Reference not containing SVHC above the threshold
Available	Available
Available	Available
WARNING: This product can expose you to chemicals including:	WARNING: This product can expose you to chemicals including:
Diisononyl phthalate (DINP), which is known to the State of California to cause cancer, and	Diisononyl phthalate (DINP), which is known to the State of California to cause cancer, and
Di-isodecyl phthalate (DIDP), which is known to the State of California to cause birth defects or other reproductive harm.	Di-isodecyl phthalate (DIDP), which is known to the State of California to cause birth defects or other reproductive harm.

The information provided in this documentation contains general descriptions and/or technical characteristics of the performance of the products contained herein. This documentation is not intended as a substitute for and is not to be used for determining suitability or reliability of these products for specific user applications. It is the duty of any such user or integrator to perform the appropriate and complete risk analysis, evaluation and testing of the products with respect to the relevant specific application or use thereof. Neither Schneider Electric Industries SAS nor any of its affiliates or subsidiaries shall be responsible or liable for misuse of the information contained herein.

Contractual warranty

Warranty period	18 months
-----------------	-----------

Dimensions

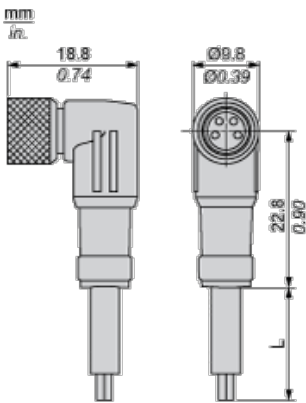

L : Length of cable

Connections and Schemes

Connector

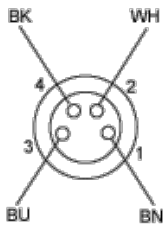

BN : Brown
BK : Black
BU : Blue
WH : White