

Amphenol®



PT Series

Miniature Cylindrical Connectors

12-070-16

| Table of Contents | Page |
|---|-------------|
| Introduction, Amphenol® Miniature Cylindrical | |
| General Information, Design Flexibility | 1, 2 |
| Connector Selection Guide | 3 |
| Insert availability | 4, 5 |
| Alternate positioning | 6 |
| Insert arrangement patterns. | 7-10 |
| PT, SP, MS/PT Proprietary/MIL-DTL-26482, Series 1 | |
| Bayonet Coupling, Solder Contacts | |
| General Information, Specifications, Service Class | 11, 12 |
| PT00 (MS3110), SP00 wall mounting receptacle | 13 |
| PT01 (MS3111) cable connecting receptacle | 14 |
| PT02 (MS3112) SP02 box mounting receptacle | 15 |
| PT06 (MS3116) SP06 straight plug | 16 |
| PT07 (MS3114) SP07 jam nut receptacle | 17 |
| PT08E, SP08E 90 degree plug | 18 |
| PT Connectors with Printed Circuit Board Contacts - box mount receptacle, jam nut receptacle | 19 |
| PTB, SPB thru bulkhead receptacle | 20 |
| General Information, Specifications - PT hermetic. | 21 |
| PTIH (MS3113H) hermetic solder mounting receptacle | 22 |
| PT02H hermetic box mounting receptacle. | 23 |
| PT07H (MS3114H) hermetic jam nut receptacle. | 24 |
| PT, SP, MS/PT how to order | 25 |
| PT-SE, SP-SE, MS/PT-SE Proprietary/MIL-DTL-26482, Series 1 | |
| Bayonet Coupling, Crimp Contacts | |
| General Information, Specifications, Service Class | 26, 27 |
| PT00SE (MS3120), SP00SE wall mounting receptacle | 28 |
| MF00SE (MS3128) wall mounting receptacle | 29 |
| PT01SE (MS3121) SP01SE cable connecting receptacle. | 30 |
| PT02SE (MS3122) SP02SE box mounting receptacle | 31 |
| MF02SE (MS3127) box mounting receptacle | 32 |
| PT06SE (MS3126), SP06SE straight plug. | 33 |
| PT07SE (MS3124) SP07SE jam nut receptacle. | 34 |
| PT08SE, SP08SE 90 degree plug | 35 |
| PT-SE, SP-SE, MS/PT-SE how to order | 36 |
| Accessories. | 37-40 |
| Glands | 41 |
| Application tools. | 42 |
| Contacts, Power and Thermocouple Crimp | 43 |
| Contacts, Shielded Coax | 44-48 |
| Mounting Recommendations | 49 |
| Other Amphenol Miniature Cylindrical Connectors | 50 |

Proprietary/MIL-DTL-26482 Series 1 connectors covered in this catalog are widely used in general duty and environmental applications, both industrial and military.

Markets that use this family of connectors include:

- Instrumentation
- Monitoring Equipment
- Machine Tool, Factory Automation
- Communications
- Geophysical
- Industrial Controls and Robotics
- Oil and Petrochemical Industries
- Rail/Mass Transit
- Military/Aerospace

If more information is needed concerning the connectors covered in this publication, or if there are special application needs, please contact:

**Amphenol Corporation
Amphenol Industrial Operations**

191 Delaware Avenue
Sidney, New York 13838-1395
Telephone: 888-364-9011
Fax: 520-397-7169

Please go to the Amphenol websites to view, download and save this catalog and most all of Amphenol interconnection product literature.

www.amphenol-industrial.com

Some miniature connector styles are available in RoHS Compliant versions. Please contact Amphenol Industrial Operations for more information.



Amphenol operates Quality Systems that are certified to ISO9001: 2008 by third party registrars.

NOTE:

The connector products in this brochure were formerly known as Bendix® products. These products are now manufactured and sold under the Amphenol® brand name. The name "Amphenol" will replace the name "Bendix" on products and literature in the future.

NOTE:

The Miniature MIL-DTL-26482, Series 2 connectors PTS-DR and MS/PTS-DR (formerly in this catalog) are no longer supplied with these designations. Amphenol now supplies the Amphenol®/Matrix® MIL-DTL-26482, Series 2. (Military numbers include MS3470 - MS3472, MS3474, - MS3476).

Amphenol® Miniature Cylindrical Connectors

Proprietary/MIL-DTL-26482, Series 1

Amphenol® Miniature Cylindrical connectors offer twice the number of contacts in just half the size of a Standard connector. These miniature connectors, are available in several series, each with varying design characteristics and customer options to meet cost considerations and provide maximum design flexibility. There are two styles within the family that are MS approved and qualified to MIL-DTL-26482, Series 1, and in addition there are several proprietary styles.

Common features of all styles:

- All are for general duty applications and environmental sealing is achieved with the grommet and clamp design.
- Operating temperature is from -55°C to $+125^{\circ}\text{C}$; Operating voltage to 1000 VAC (RMS) at sea level.
- Pin and socket contacts are machined from low loss copper alloy and gold plated to eliminate contact corrosion and provide an indefinite shelf life.
- All have resilient inserts which provide high dielectric strength and moisture barrier.
- A variety of shell finishes (including non-cadmium) and a variety of backend accessories are available within the styles.



PT Solder
jam nut receptacle and
mated straight plug

Bayonet Coupling with Solder Contact Termination

PT, MS/PT (solder)

- MS and proprietary versions
- Factory installed solder contacts
- 3 point bayonet coupling and 5 key/keyway mating.
- Intermateable with all miniature series connectors.
- MS/PT meets MIL-DTL-26482 Series 1, service classes E, F and P.
- MS/PT is UL recognized.

Options

- 7 shell styles with 60 insert patterns
- Hermetic seal (glass fusion) receptacle styles available
- Pressurized thru bulkhead receptacle style available
- Pre-installed coax solder contacts are available
- Printed circuit board contacts are available



SP (solder)

- SP Series is a modification of the PT with same features except a wider flange for back panel mounting

Bayonet Coupling with Crimp Contact Termination

PT Solder
wall mount receptacle

PT-SE, MS/PT-SE (crimp)

- MS and proprietary versions
- Crimp rear insertable/front release contact termination. (closed entry socket insert prevents probe damage).
- 3 point bayonet coupling and 5 key/keyway mating.
- Intermateable with all miniature series connectors.
- MS/PT-SE meets MIL-DTL-26482 Series 1, service classes E, F, P.

Options

- 6 shell styles with 47 insert patterns
- Coax and thermocouple contacts are available



PT-SE Crimp
wall mount receptacle
and mated straight plug

SP-SE (crimp)

- Modification of the PT-SE with wider flange for back panel mounting

Amphenol® Miniature Cylindrical design flexibility

The large family of miniature proprietary and MS style connectors provides for many optional features and designs. In addition to the choices of bayonet or threaded shells, solder or crimp termination within the style variations, there are additional options that are shown here.

Hermetics

Hermetically sealed receptacles have fused compression glass sealed inserts which provide environmental moisture sealing. There are three hermetic styles within the PT bayonet series.

Coaxial Contacts

Amphenol Miniature connectors can incorporate shielded coax contacts. Size 8 and 12 crimp coax contacts are available in PT-SE, SP-SE, MS/PT-SE. Factory installed size 8 and 12 solder type coax contacts are available in PT, SP,MS/PT connectors. See coax contact information pages at the end of this catalog.

Printed Circuit Board Tail Contacts

PT bayonet connectors in box mounting receptacle and jam nut receptacle styles are available with printed circuit board contacts. Standard PCB tails for MIL-DTL-26482 connectors have gold plating, .0050 inches over nickel. See page 20 and call Amphenol for further information.

Flex Circuitry

Flex termination assemblies for attaching cylindrical connectors to printed circuit boards are available through the Amphenol division ACT, Advanced Circuit Technology. Flex can be used with miniature 26482 connectors and it can be designed to meet specific length, current carrying capacity and to fit the precise geometric shape of the connector to board package. Flex circuitry plugs into a printed circuit board and creates a self-locking terminal pad which eliminates the need for an additional interconnect to the PCB.

Filter Protection

Amphenol offers the FPT Series which combines the miniature PT series with an EMI filter. Designed to provide EMI protection for sensitive circuits, each circuit is individually filtered within the connector, eliminating the need for costly and bulky exterior network filters. Filter contacts are available in MF, HF, VHF, and UHF ranges and are intermateable and intermountable with MIL-DTL-26482 connectors. For further information see catalog 12-120, Amphenol EMI Filter Transient Protection Connectors.

Overmolded Cable

Overmold seals and cables can be designed for almost any industrial application. A variety of materials are available: neoprene, hypalon and others; and a variety of lengths can be designed to meet customer specifications. Overmold seals to the rear of the connector and to the cable jacket providing moisture sealing.

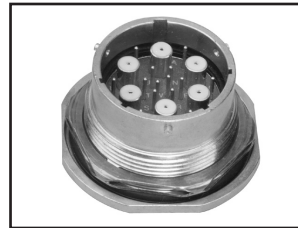

PT Connector with Hermetic Seal Insert and Coax Contacts



PT Connector with PC Tail Contacts

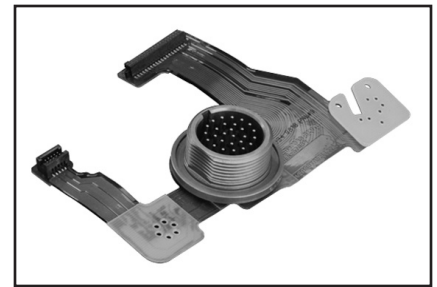

PT Connector with Flex



PT Connector with EMI Filter Protection



PT Connector with Overmolded Cable

Amphenol® Miniature Cylindrical connector selection guide

The accompanying chart is provided to assist the user in selecting the appropriate type of miniature connector to meet the application requirements. Further information can be found in specific sections of this catalog.

| CHARACTERISTICS | | Solder | | | Crimp | |
|--------------------------------------|--|--------|-------|----|----------|-------|
| | | PT | MS/PT | SP | MS/PT-SE | PT-SE |
| Intermateable† | | o | o | o | o | o |
| Contacts | Solder | • | • | • | | |
| | Crimp RI/FR | | | | • | • |
| Contact Retention System | Non-Removable | • | • | • | | |
| | Removable | | | | • | • |
| Coupling | Bayonet | • | • | • | • | • |
| Standard Finishes†† | Olive Drab Cadmium (003) | • | • | | • | • |
| | Anodic Coated (005) | | | • | | |
| Temperature Range | Resilient Dielectric (-55°C to +125°C) | • | • | • | • | • |
| Wide Mounting Flange | | | | • | | |
| Hermetic Seal | | • | • | • | | |
| SHELL STYLE AVAILABILITY | | | | | | |
| Wall Mounting Receptacle "00" | | • | • | • | • | **• |
| Cable Connecting Receptacle "01" *** | | • | • | | • | • |
| Box Mounting Receptacle "02" | | *• | • | • | • | **• |
| Straight Plug "06" | | • | • | • | • | • |
| Jam Nut Receptacle "07" | | *• | *• | • | • | • |
| Thru-bulkhead Receptacle "TB" | | • | | • | | |
| Solder Mount Receptacle "I" | | *• | *• | | | |
| 90° Plug "08" | | • | | • | | • |

RI/FR = Rear Insertion/Front Releasable

† o intermates with o

†† Optional finishes available. See "how to order" sections.

* Available in hermetic version

** Dual mounting holes

*** This connector style is sometimes referred to as a cable connecting "plug." It does, however, mate with either a straight or 90 degree plug.

Amphenol® Miniature Cylindrical insert availability

| Insert Arrangement | Solder Termination | | | | Crimp Termination | | Total Contacts | Contact Size | | | | |
|--------------------|--------------------|----|----|-------------------|----------------------------|----|----------------|--------------|----|------|---|----------------|
| | MS/PT | PT | SP | Hermetic PT MS-PT | MS/PT-SE PT-SE SP-SE | 20 | | 16 | 12 | Coax | | Service Rating |
| | | | | | | | | | | 12 | 8 | |
| 6-1 | | X | X | X* | | 1 | 1 | | | | | I |
| 8-2 | X | X | X | X | | 2 | 2 | | | | | I |
| 8-3 | X | X | X | X | | 3 | 3 | | | | | I |
| 8-4 | X | X | X | X | | 4 | 4 | | | | | I |
| 8-33 | X | X | X | X | X | 3 | 3 | | | | | I |
| 8-98 | | X | X | | | 3 | 3 | | | | | I |
| 10-2 | | X | X | | | 2 | | 2 | | | | I |
| 10-5 | | X | X | X* | | 5 | 5 | | | | | I |
| 10-6 | X | X | X | X | X | 6 | 6 | | | | | I |
| 10-70 | | X | X | | | 1 | | | | | 1 | Coax |
| 10-98 | X | X | X | X* | | 6 | 6 | | | | | I |
| 12-3 | X | X | X | X | X | 3 | | 3 | | | | II |
| 12-4 | | X | X | X* | | 4 | | 4 | | | | I |
| 12-8 | X | X | X | X* | X | 8 | 8 | | | | | I |
| 12-10 | X | X | X | X | X | 10 | 10 | | | | | I |
| 12-14 | | X | X | | | 14 | 14 | | | | | I |
| 12-98 | | X | X | | | 10 | 10 | | | | | I |
| 14-2 | | X | X | | | 2 | | | | 2 | | II |
| 14-4 | | S | S | X | | 4 | | | 4 | | | I |
| 14-5 | X | X | X | X | X | 5 | | 5 | | | | II |
| 14-8 | | X | X | | | 8 | 6 | | 2 | | | I |
| 14-12 | X | X | X | X | X | 12 | 8 | 4 | | | | I |
| 14-15 | X | X | X | X | X | 15 | 14 | 1 | | | | I |
| 14-18 | X | X | X | X* | X | 18 | 18 | | | | | I |
| 14-19 | X | X | X | X | X | 19 | 19 | | | | | I |
| 14-22 | | | | | X* | 5 | 1 | | 4 | | | I |
| 14-71 | | P | X | | | 4 | | 3 | | | 1 | I |
| 14-91 HV | | S | X | | X* | 3 | 3 | | | | | ** |
| 14-AA | | X | X | X | | 4 | | | 4 | | | I |
| 16-8 | X | X | X | X | X | 8 | | 8 | | | | II |
| 16-23 | X | X | X | | X | 23 | 22 | 1 | | | | I |
| 16-26 | X | X | X | X | X | 26 | 26 | | | | | I |
| 16-70 | | X | X | | | 15 | 14 | | | 1 | | N/A |
| 16-76††† | | | | | X* | 14 | 8 | | 1 | 5 | | *** |
| 16-99 | X | X | X | | X | 23 | 21 | 2 | | | | I |
| 18-5 | | X | X | | X* | 5 | | | 5 | | | II |
| 18-8 | | | | | | 8 | | | 8 | | | I |
| 18-11 | X | X | X | X | X | 11 | | 11 | | | | II |
| 18-30 | X | X | X | X* | X | 30 | 29 | 1 | | | | I |

*Not available in MS version
 **Flashover voltage 5,000 VAC (RMS)
 ***1500 VAC (RMS)
 S designates Socket insert only.

P designates Pin insert only.
 †Size 12 contacts for #10 wire
 ††Not presently tooled
 †††Contacts must be ordered separately

Amphenol® Miniature Cylindrical insert availability, cont.

| Insert Arrangement | Solder Termination | | | | Crimp Termination | Total Contacts | Contact Size | | | | | Service Rating |
|--------------------|--------------------|----|----|-------------------|----------------------------|----------------|--------------|----|----|------|---|----------------|
| | MS/PT | PT | SP | Hermetic PT MS-PT | MS/PT-SE PT-SE SP-SE | | 20 | 16 | 12 | Coax | | |
| | | | | | | | | | | 12 | 8 | |
| 18-32 | X | X | X | X | X | 32 | 32 | | | | | I |
| 18-71 | | | | | X* | 9 | | 8 | | | 1 | Coax, II |
| 18-72 | | X | X | | | 14 | 10 | | | 4 | | N/A |
| 18-75 | | X | X | | | 4 | | | | | 4 | Coax |
| 18-76 | | | | | | 4 | | | | 3 | 1 | II |
| 18-80 | | X | X | | | 8 | 6 | | | | 2 | Coax, I |
| 18-91 HV | | | | | X* | 6 | 6 | | | | | ** |
| 20-16 | X | X | X | X | X | 16 | | 16 | | | | II |
| 20-24 | X | X | X | | | 24 | 24 | | | | | I |
| 20-25 | | X | X | | | 25 | 25 | | | | | I |
| 20-26 | | X | X | | | 26 | 20 | | 6 | | | I |
| 20-27 | X | X | X | | | 27 | 27 | | | | | I |
| 20-39 | X | X | X | X | X | 39 | 37 | 2 | | | | I |
| 20-41 | X | X | X | X | X | 41 | 41 | | | | | I |
| 20-70 | | | | | | 14 | 10 | | | | 4 | Coax |
| 20-90 HV | | X | X | | | 7 | 7 | | | | | Hi-Voltage |
| 22-7 | | X | X | | X* | 7 | | | | | 7 | Coax |
| 22-21 | X | X | X | X | X | 21 | | 21 | | | | II |
| 22-25 | | | | | X* | 25 | | 25 | | | | I |
| 22-32 | X | X | X | | X | 32 | 32 | | | | | I |
| 22-34 | | X | X | | | 34 | 34 | | | | | I |
| 22-36 | | X | X | | | 36 | 36 | | | | | I |
| 22-41 | X | X | X | X | X | 41 | 27 | 14 | | | | I |
| 22-55 | X | X | X | X | X | 55 | 55 | | | | | I |
| 22-70 | | X | X | | | 19 | 13 | | | | 6 | I, Coax |
| 22-71 | | | | | | 9 | 2 | | | | 7 | I, Coax |
| 22-72 | | X | X | | | 19 | 12 | 4 | | | 3 | N/A |
| 22-78††† | | | | | X* | 7 | | | | | 7 | Coax |
| 22-96 | | | | | X* | 7 | | | 7† | | | II |
| 24-31 | | X | X | | | 31 | | 31 | | | | I |
| 24-51 | | | | | X* | 51 | 47 | | | 4 | | I |
| 24-61 | X | X | X | X | X | 61 | 61 | | | | | I |
| 24-71 | | X | X | | | 49 | 45 | 2 | | | 2 | N/A |
| 24-79 | | | | | | 6 | 1 | | | | 5 | Coax |

*Not available in MS version
 **Flashover voltage 5,000 VAC (RMS)
 ***1500 VAC (RMS)

†Size 12 contacts for #10 wire
 ††Not presently tooled
 †††Contacts must be ordered separately

Amphenol® Miniature Cylindrical alternate positioning

Alternate Positioning

To avoid cross-plugging problems in applications requiring the use of more than one miniature cylindrical connector of the same size and arrangement, alternate insert rotations are available as indicated in the accompanying chart.

As shown in the diagram at right, the front face of the pin insert is rotated within the shell in a clockwise direction from the normal shell key. The socket insert would be rotated counterclockwise the same number of degrees in respect to the normal shell key.

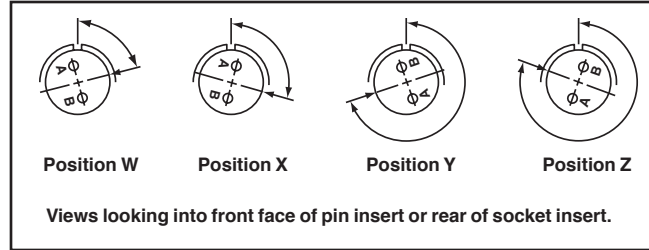

| Shell Size | Insert Arrangement | Insert Rotation | | | |
|------------|--------------------|-----------------|-----|-----|-----|
| | | Degrees | | | |
| | | W | X | Y | Z |
| 6 | 6-1 | – | – | – | – |
| 8 | 8-2* | 58 | 122 | – | – |
| 8 | 8-3 | 60 | 210 | – | – |
| 8 | 8-4* | 45 | 97 | 184 | – |
| 8 | 8-33* | 90 | – | – | – |
| 8 | 8-98 | – | – | – | – |
| 10 | 10-2 | 45 | 90 | 315 | – |
| 10 | 10-5* | 45 | 151 | 180 | 270 |
| 10 | 10-6* | 90 | – | – | – |
| 10 | 10-70 | – | – | – | – |
| 10 | 10-98* | 90 | 180 | 240 | 270 |
| 12 | 12-3* | – | – | 180 | – |
| 12 | 12-4* | 38 | – | – | – |
| 12 | 12-8 | 90 | 112 | 203 | 292 |
| 12 | 12-10* | 60 | 155 | 270 | 295 |
| 12 | 12-14 | – | – | – | – |
| 12 | 12-98* | 61 | 135 | 189 | 340 |
| 14 | 14-2 | 58 | 122 | – | – |
| 14 | 14-4* | 45 | – | – | – |
| 14 | 14-5* | 40 | 92 | 184 | 273 |
| 14 | 14-8 | 48 | 162 | 189 | 312 |
| 14 | 14-12* | 43 | 90 | – | – |
| 14 | 14-15* | 17 | 110 | 155 | 234 |
| 14 | 14-18* | 15 | 90 | 180 | 270 |
| 14 | 14-19* | 30 | 165 | 315 | – |
| 14 | 14-22 | 45 | – | – | – |
| 14 | 14-71 | – | – | – | – |
| 14 | 14-91HV | – | 60 | – | – |
| 14 | 14-AA* | 45 | – | – | – |
| 16 | 16-8* | 54 | 152 | 180 | 331 |
| 16 | 16-23 | 158 | 270 | – | – |
| 16 | 16-26* | 60 | – | 275 | 338 |
| 16 | 16-70 | 41 | 122 | 216 | 286 |
| 16 | 16-76 | – | – | – | – |
| 16 | 16-99* | 66 | 156 | 223 | 340 |
| 18 | 18-5 | 55 | 97 | 263 | 315 |
| 18 | 18-8 | 180 | – | – | – |

| Shell Size | Insert Arrangement | Insert Rotation | | | |
|------------|--------------------|-----------------|-----|-----|-----|
| | | Degrees | | | |
| | | W | X | Y | Z |
| 18 | 18-11* | 62 | 119 | 241 | 340 |
| 18 | 18-30* | 180 | 193 | 285 | 350 |
| 18 | 18-32* | 85 | 138 | 222 | 265 |
| 18 | 18-71 | 18 | 108 | 127 | 215 |
| 18 | 18-72 | 53 | 102 | 213 | 293 |
| 18 | 18-75 | 45 | – | – | – |
| 18 | 18-76 | – | – | – | – |
| 18 | 18-80 | 45 | 90 | 135 | 160 |
| 18 | 18-91HV | 90 | 180 | 240 | 270 |
| 20 | 20-16* | 238 | 318 | 333 | 347 |
| 20 | 20-24 | 70 | 145 | 215 | 290 |
| 20 | 20-25 | 72 | 144 | 216 | 288 |
| 20 | 20-26 | 13 | 107 | 210 | 322 |
| 20 | 20-27 | 72 | 144 | 216 | 288 |
| 20 | 20-39* | 63 | 144 | 252 | 333 |
| 20 | 20-41* | 45 | 126 | 225 | – |
| 20 | 20-70 | 63 | 135 | 222 | 335 |
| 20 | 20-90 | 45 | 135 | 225 | 315 |
| 22 | 22-7 | 19 | 41 | – | – |
| 22 | 22-21* | 16 | 135 | 175 | 349 |
| 22 | 22-25 | 60 | 125 | 211 | 336 |
| 22 | 22-32 | 72 | 145 | 215 | 288 |
| 22 | 22-34 | 62 | 142 | 218 | 298 |
| 22 | 22-36 | 72 | 144 | 216 | 288 |
| 22 | 22-41 | 39 | 135 | 264 | – |
| 22 | 22-55* | 30 | 142 | 226 | 314 |
| 22 | 22-70 | 30 | 82 | 218 | 312 |
| 22 | 22-71 | 33 | 191 | 236 | 270 |
| 22 | 22-72 | 42 | 200 | 277 | 339 |
| 22 | 22-78 | 19 | 41 | – | – |
| 22 | 22-96* | 19 | 41 | – | – |
| 24 | 24-31 | 90 | 225 | 255 | – |
| 24 | 24-51 | 22 | 171 | 313 | – |
| 24 | 24-61* | 90 | 180 | 270 | 324 |
| 24 | 24-71 | 39 | 131 | 205 | 281 |
| 24 | 24-79 | – | – | – | – |

* Available in Hermetic Class

Amphenol® Miniature Cylindrical insert arrangements

front face of pin inserts illustrated

| | | | | | | | |
|---------------------------|--------------|--------------|---------------|--------------|--------------|------------------|------------------------|
| | | | | | | | |
| Insert Arrangement | 6-1 | 8-2 | 8-3 | 8-4 | 8-33 | 8-98 | 10-2 |
| Service Rating | I | I | I | I | I | I | I |
| Number of Contacts | 1 | 2 | 3 | 4 | 3 | 3 | 2 |
| Contact Size | 20 | 20 | 20 | 20 | 20 | 20 | 16 |
| | | | | | | | |
| Insert Arrangement | 10-5 | 10-6 | 10-70 | 10-98 | 12-3 | 12-4 | 12-8 |
| Service Rating | I | I | Coax | I | II | I | I |
| Number of Contacts | 5 | 6 | 1 | 6 | 3 | 4 | 8 |
| Contact Size | 20 | 20 | 8 Coax | 20 | 16 | 16 | 20 |
| | | | | | | | |
| Insert Arrangement | 12-10 | 12-14 | 12-98 | 14-2 | 14-4 | 14-5 | 14-8 |
| Service Rating | I | I | I | II | I | II | I |
| Number of Contacts | 10 | 14 | 10 | 2 | 4 | 5 | 6 2 |
| Contact Size | 20 | 20 | 20 | 12 | 12 | 16 | 20 12 |
| | | | | | | | |
| Insert Arrangement | 14-12 | 14-15 | 14-18 | 14-19 | 14-22 | 14-71 | 14-91HV |
| Service Rating | I | I | I | I | I | I | Flashover |
| Number of Contacts | 8 4 | 14 1 | 18 | 19 | 1 4 | 3 1 | 5,000 VAC (RMS) |
| Contact Size | 20 16 | 20 16 | 20 | 20 | 20 12 | 16 8 Coax | 3 |
| | | | | | | | |

Amphenol® Miniature Cylindrical insert arrangements

front face of pin inserts illustrated

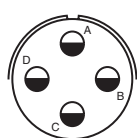

14-AA

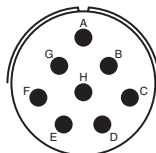

16-8

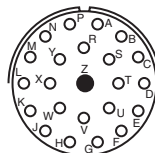

16-23

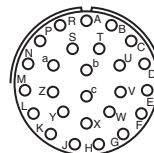

16-26

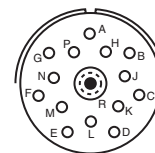

16-70

Insert Arrangement
Service Rating
Number of Contacts
Contact Size

I
4
12

II
8
16

I
22 1
20 16

I
26
20

N/A
14 1
20 12 Coax

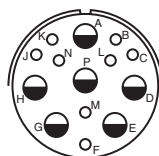

16-76

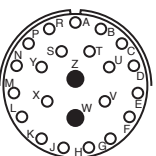

16-99

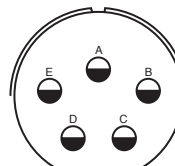

18-5

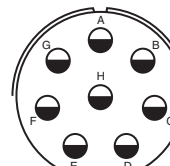

18-8

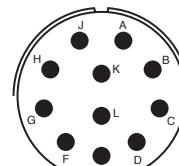

18-11

Insert Arrangement
Service Rating
Number of Contacts
Contact Size

Flashover
1.500 VAC (RMS)
8 1 5
20 12* 2 Coax*

I
21 2
20 16

II
5
12

I
8
12

II
11
16

*Contact Positions Optional

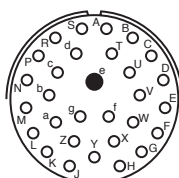

18-30

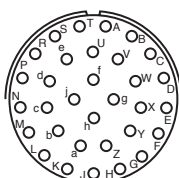

18-32

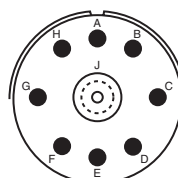

18-71

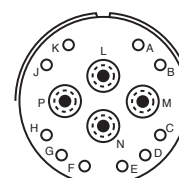

18-72

Insert Arrangement
Service Rating
Number of Contacts
Contact Size

I
29 1
20 16

I
32
20

II, Coax
8 1
16 8 Coax

N/A
10 4
20 12 Coax

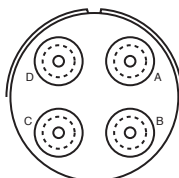

18-75

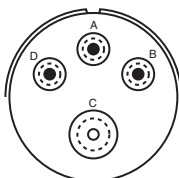

18-76

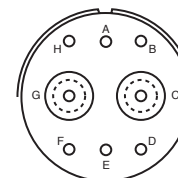

18-80

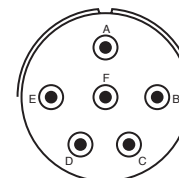

18-91 HV

Insert Arrangement
Service Rating
Number of Contacts
Contact Size

Coax
4
8 Coax

II
3 1
12 Coax 8 Coax

I, Coax
6 2
20 8 Coax

Flashover
5,000 VAC (RMS)
6
20

Amphenol® Miniature Cylindrical insert arrangements

front face of pin inserts illustrated



20-16
II
16
16

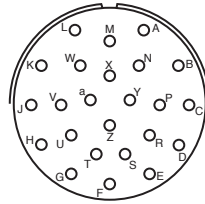

20-24
I
24
20

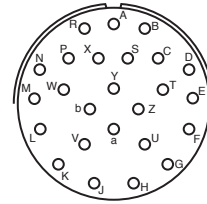

20-25
I
25
20

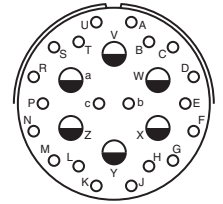

20-26
I
20 6
20 12

Insert Arrangement
Service Rating
Number of Contacts
Contact Size

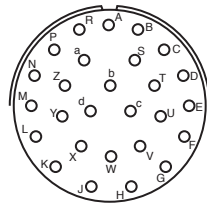

20-27
I
27
20

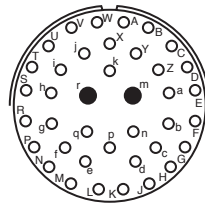

20-39
I
37 2
20 16

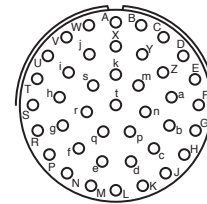

20-41
I
41
20

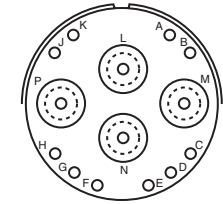

20-70
Coax
10 4
20 8 Coax

Insert Arrangement
Service Rating
Number of Contacts
Contact Size

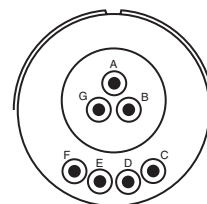

20-90
Hi-Voltage
7
20

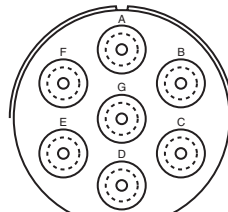

22-7
Coax
7
8 Coax

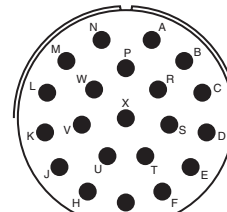

22-21
II
21
16

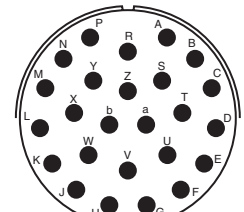

22-25
I
25
16

Insert Arrangement
Service Rating
Number of Contacts
Contact Size

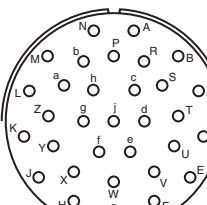

22-32
I
32
20

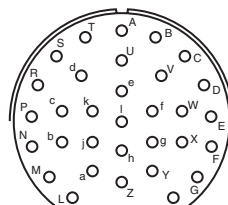

22-34
I
34
20

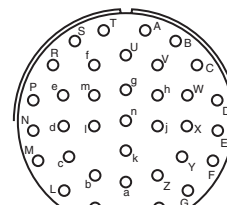

22-36
I
36
20

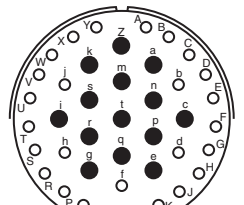

22-41
I
27 14
20 16

Insert Arrangement
Service Rating
Number of Contacts
Contact Size

Amphenol® Miniature Cylindrical insert arrangements

front face of pin inserts illustrated

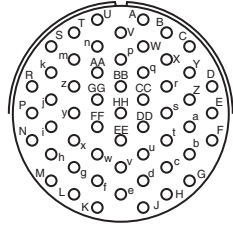

22-55

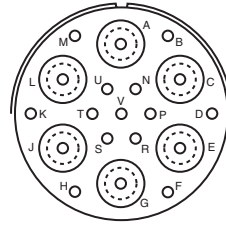

22-70

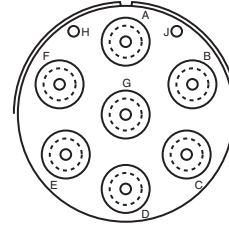

22-71

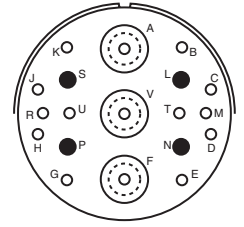

22-72

Insert Arrangement
Service Rating
Number of Contacts
Contact Size

I

55

20

I, Coax

13 6

20 8 Coax

I, Coax

2 7

20 8 Coax

N/A

12 4 3

20 16 8 Coax

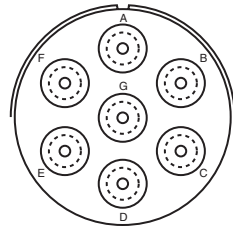

22-78

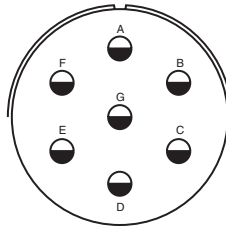

22-96

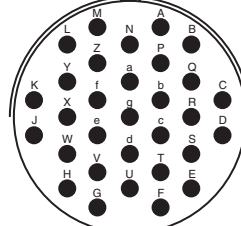

24-31

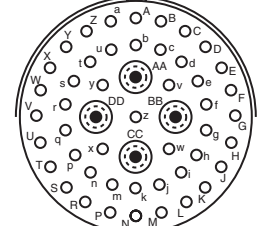

24-51

Insert Arrangement
Service Rating
Number of Contacts
Contact Size

Coax

7

8 Coax

II

7

12 for

10 wire

I

31

16

I

47 4

20 12 Coax

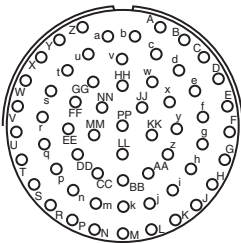

24-61

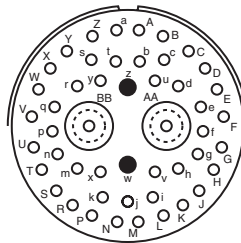

24-71

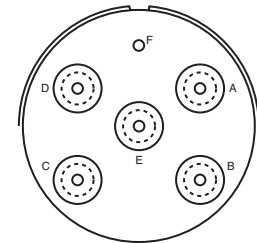

24-79

Insert Arrangement
Service Rating
Number of Contacts
Contact Size

I

61

20

N/A

45 2 2

20 16 8 Coax

Coax

1 5

20 8 Coax

Contact Legend

| Symbol | Contact Size |
|--------|--------------|
| ○ | 20 |
| ● | 16 |
| ◐ | 12 |
| ⊙ | HV |
| ⊗ | 12 Coax |
| ⊘ | 8 Coax |

Amphenol® PT, SP, MS/PT

Proprietary/MIL-DTL-26482, Series 1 bayonet coupling and solder termination

wall mounting receptacle



cable connecting receptacle*



box mounting receptacle



straight plug



jam nut receptacle



thru bulkhead receptacle

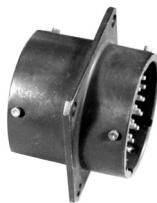

Amphenol® solder contact miniature cylindrical connectors meet the most critical application needs. Design versatility combined with high reliability performance makes these series of Miniature Cylindrical Connectors ideal for environmental sealing or pressurized applications.

The MS/PT Series is qualified to MIL-DTL-26482, Series 1 and has all the outstanding design characteristics and quality of the PT Series. The SP Series is a modification of the PT, providing special shells with a wide mounting flange for back panel mounting.

A corrosion resistant electrically conductive finish of cadmium plate with an olive drab chromate after-treatment is used on the PT and MS/PT. The SP is given a durable non-conductive hard anodic "Alumilite"® coating which provides abrasion protection and resistance to corrosion.

NEW 500 hour corrosion resistance, RoHS compliant harsh environment conductive plating. Gray Zinc over an Electroless Nickel (Gray ZnNi) base, with a Light Gun Metal Gray appearance.

Shell components for these series are aluminum. The dependable 5 key/keyway polarization with bayonet lock coupling assures positive mating with no chance of cross plugging. Spring tension provided by a wave washer in the coupling nut ensures maintenance of interfacial seal between mating halves.

Both the insert and main joint gasket are molded from resilient neoprene. This provides excellent moisture sealing at the gasket and superior electrical isolation of the contact in the insert.

Both pins and sockets are machined from a copper alloy and are gold plated. This gold plating eliminates contact corrosion and offers an indefinite shelf life. Socket contacts for these series are a closed entry design. A breakaway style plug is available in the PT solder series. Hermetics receptacles are available in PT and MS/PT solder series. Receptacles with printed circuit board contacts are also available.

PT Solder is UL recognized under file #E115497, Vol. 1, Sec. 5.

The PT, SP and MS/PT Series are intermateable and intermountable with all existing Miniature Cylindrical Series connectors.

Refer to pages 4-10 for insert arrangement availability.

PT, SP, MS/PT

Table 1: CONTACT DATA/CONNECTOR RATINGS

| Contact Specifications | | | | | |
|------------------------|---|-------------------------------|----------------------|---------------------|-------------|
| Contact Size | Test Current | Maximum Millivolt Drop† | Solder Well Diameter | Solder Well Depth | |
| 20 | 7.5 | 55 | .046 +.004 -.000 | .125 +.031 -.000 | |
| 16 | 13.0 | 50 | .078 +.005 -.003 | .188 +.031 -.000 | |
| 12 | 23.0 | 42 | .116 +.004 -.002 | .188 +.031 -.000 | |
| Service Rating | | | | | |
| Service Rating | Recommended Operating AC Voltage at Sea Level | Test Voltage AC (RMS), 60 cps | | | |
| | | Sea Level | 50,000 ft. | 70,000 ft. | 110,000 ft. |
| I | 600 | 1,500 | 500 | 375 | 200 |
| II | 1,000 | 2,300 | 750 | 500 | 200 |

† Silver plated wire per MIL-DTL-26482

*This connector style is sometimes referred to as a cable connecting "plug." It does, however, mate with a straight or 90 degree plug.

PT, SP Service Classes

PT and SP connectors are available in the service classes listed below. Each class, with the exception of hermetic, offers one or more means of terminating or supporting a cable or wire bundle.

- “A” General duty; back shell is threaded for conduit attachment of MS3057 cable clamp
- “A” (SR) General duty, with strain relief clamp for cable or wire bundle support
- “C” Pressurized receptacle; less than 1 cu. in. per hour leakage at 30 psi over a temperature range of -65°F to +257°F
- “E” Environmental resistant connectors - supplied with a multi-holed grommet and clamping nut for moisture-proofing individual open wires
- “E” (SR) Environmental resistant strain relief clamp and grommet for moisture proofing individual wires; provides added wire bundle support
- “P” Translucent nylon boot for retaining customer-applied potting compounds; held in place by a threaded ring
- “P” (SR) Strain relief clamp suitable for retaining customer applied potting compounds, with provision for wire support
- “PG” Compressing cable gland for moisture proofing jacketed cables.
- “H”* Hermetically sealed with compression glass inserts (see pages 22-25)

Style with printed circuit board contacts- see page 20.

MS/PT Service Classes

The MS/PT Miniature connector is available in the following certified service classes:

- “E” Environmental resistant connectors - supplied with a multi-holed grommet and clamping nut for moisture-proofing individual open wires
- “F” Grommet seal with strain relief clamp
- “J” Compressing clamp and neoprene gland for moisture proofing multi-conductor jacketed cable and strain relief. Telescoping sleeves (MS 3420A) can be used to adapt to cables smaller than minimum close-down.
- “P” Translucent nylon boot for retaining customer-applied potting compounds; held in place by a threaded ring



PT00 (MS3110) SP00 wall mounting receptacle

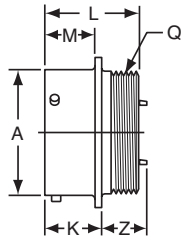
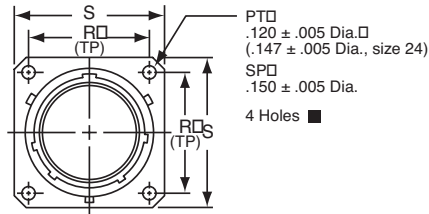

TERMINATION ASSEMBLIES

“A” General Duty/
“C” Pressurized

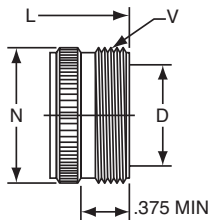

PT00A-XX-XXX
SP00A-XX-XXX
PT00C-XX-XXX

“A” (SR), “E” (SR), “P” (SR),
MS / “F” Strain Relief

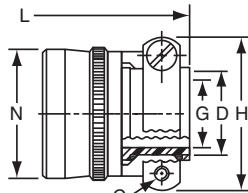

PT00A-XX-XXX (SR)
SP00A-XX-XXX (SR)
PT00E-XX-XXX (SR)
SP00E-XX-XXX (SR)
PT00P-XX-XXX (SR)
SP00P-XX-XXX (SR)
MS3110F-XX-XXX

“E” Open Wire Seal

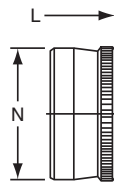

PT00E-XX-XXX
SP00E-XX-XXX
MS3110E-XX-XXX

“P” Potting Boot

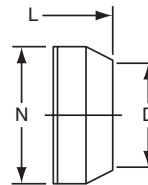

PT00P-XX-XXX
SP00P-XX-XXX
MS3110P-XX-XXX

“PG” Cable Gland Seal

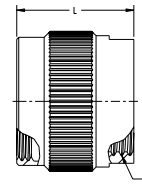

PT00PG-XX-XXX

“J” Cable Seal

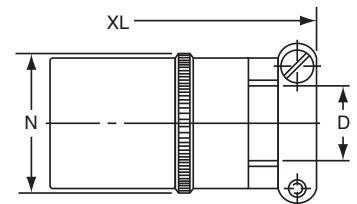

MS3110J-XX-XXX

To complete part number see how to order on page 25.

■ (MMC) located within .0025 of (TP)

| Shell Size | Receptacle Front View | | | | Receptacle Side View | | | | | | | | Class “A”, “C” | | | | |
|------------|-----------------------|-------|--------|-------|----------------------|------------------|------|--------|------------------|------|-------------------|--------|----------------|--------|--------|--------|------------------|
| | R (TP) | | S Max. | | A +.001 -.005 | K +.020 -.010 | | L Max. | M +.010 -.000 | | Q Thread Class 2A | Z Max. | | D Min. | L Max. | N Max. | V Thread Class A |
| | PT | SP | PT | SP | | PT | SP | | PT | SP | | PT | SP | | | | |
| 6 | .469 | .641 | .688 | .953 | .348 | .493 | .524 | .906 | .431 | .462 | .3125-32 NEF | .468 | .438 | .175 | 1.553 | .462 | .3750-32 NEF |
| 8 | .594 | .734 | .812 | 1.047 | .473 | .493 | .524 | .906 | .431 | .462 | .4375-28 UNEF | .468 | .438 | .297 | 1.553 | .590 | .5000-28 UNEF |
| 10 | .719 | .812 | .938 | 1.125 | .590 | .493 | .524 | .906 | .431 | .462 | .5625-24 NEF | .468 | .438 | .421 | 1.553 | .717 | .6250-24 NEF |
| 12 | .812 | .938 | 1.031 | 1.250 | .750 | .493 | .524 | .906 | .431 | .462 | .6875-24 NEF | .468 | .438 | .546 | 1.553 | .834 | .7500-20 UNEF |
| 14 | .906 | 1.031 | 1.125 | 1.344 | .875 | .493 | .524 | .906 | .431 | .462 | .8125-20 UNEF | .468 | .438 | .663 | 1.553 | .970 | .8750-20 UNEF |
| 16 | .969 | 1.125 | 1.219 | 1.438 | 1.000 | .493 | .524 | .906 | .431 | .462 | .9375-20 UNEF | .468 | .438 | .787 | 1.553 | 1.088 | 1.0000-20 UNEF |
| 18 | 1.062 | 1.203 | 1.312 | 1.516 | 1.125 | .493 | .524 | .906 | .431 | .462 | 1.0625-18 NEF | .531 | .438 | .879 | 1.553 | 1.216 | 1.1875-18 NEF |
| 20 | 1.156 | 1.297 | 1.438 | 1.672 | 1.250 | .650 | .650 | 1.125 | .556 | .556 | 1.1875-18 NEF | .531 | .531 | 1.014 | 1.703 | 1.332 | 1.1875-18 NEF |
| 22 | 1.250 | 1.375 | 1.562 | 1.750 | 1.375 | .650 | .650 | 1.125 | .556 | .556 | 1.3125-18 NEF | .531 | .531 | 1.134 | 1.703 | 1.460 | 1.4375-18 NEF |
| 24 | 1.375 | 1.500 | 1.688 | 1.875 | 1.500 | .683 | .683 | 1.188 | .589 | .589 | 1.4375-18 NEF | .498 | .498 | 1.259 | 1.765 | 1.585 | 1.4375-18 NEF |

| Shell Size | Class “A” (SR), “E” (SR), “P” (SR), MS / “F” | | | | | Class “E”, MS / “E” | | | Class “P”, MS / “P” | | | Class “J” | | | Class “PG” | | |
|------------|--|--------|--------|--------|--------|---------------------|--------|--------|---------------------|--------|--------|-----------|------|--------|------------|------------|--------|
| | C Thread | D Min. | G Max. | H Max. | L Max. | N Max. | L Max. | N Max. | D Min. | L Max. | N Max. | D | | N Max. | XL Max. | B Thread | L Max. |
| | | | | | | | | | | | | Closed | Free | | | | |
| 6 | - | - | - | - | - | - | 1.266 | .440 | .192 | 1.438 | .484 | - | - | - | - | - | - |
| 8 | 6-32 | .240 | .125 | .812 | 1.922 | .550 | 1.266 | .560 | .317 | 1.438 | .608 | .168 | .230 | .547 | 2.271 | M12x1.5-6H | .936 |
| 10 | 6-32 | .302 | .188 | .875 | 1.922 | .675 | 1.266 | .685 | .434 | 1.438 | .734 | .205 | .312 | .675 | 2.271 | M16x1.5-6H | .936 |
| 12 | 6-32 | .428 | .312 | 1.000 | 1.922 | .803 | 1.266 | .813 | .548 | 1.438 | .858 | .338 | .442 | .812 | 2.411 | M16x1.5-6H | .936 |
| 14 | 6-32 | .552 | .375 | 1.125 | 1.922 | .920 | 1.266 | .930 | .673 | 1.438 | .984 | .416 | .539 | .940 | 2.599 | M18x1.5-6H | .936 |
| 16 | 6-32 | .615 | .500 | 1.188 | 2.047 | 1.047 | 1.266 | 1.057 | .798 | 1.438 | 1.110 | .550 | .616 | 1.067 | 2.943 | M22x1.5-6H | .936 |
| 18 | 8-32 | .740 | .625 | 1.438 | 2.078 | 1.165 | 1.266 | 1.175 | .899 | 1.438 | 1.234 | .600 | .672 | 1.194 | 3.172 | M25x1.5-6H | .936 |
| 20 | 8-32 | .740 | .625 | 1.438 | 2.344 | 1.290 | 1.516 | 1.301 | 1.024 | 1.656 | 1.360 | .635 | .747 | 1.322 | 3.610 | M25x1.5-6H | 1.180 |
| 22 | 8-32 | .928 | .750 | 1.625 | 2.344 | 1.418 | 1.516 | 1.430 | 1.149 | 1.656 | 1.484 | .670 | .846 | 1.449 | 3.766 | M32x1.5-6H | 1.180 |
| 24 | 8-32 | .990 | .800 | 1.719 | 2.406 | 1.543 | 1.578 | 1.555 | 1.274 | 1.717 | 1.610 | .740 | .894 | 1.576 | 3.985 | M32x1.5-6H | 1.180 |

All dimensions for reference only.

PT01 (MS3111)

cable connecting receptacle

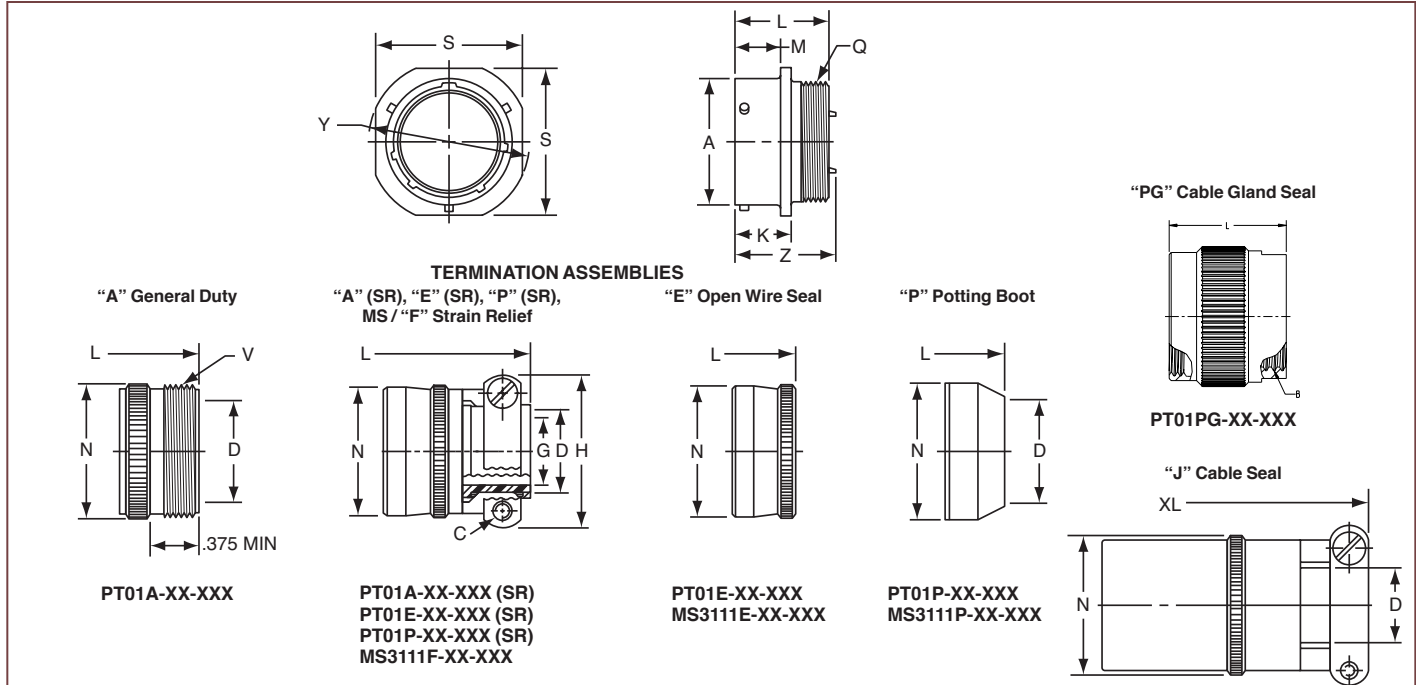

Note: This connector style is sometimes referred to as a cable connecting "plug".
 It does, however, mate with either a straight or 90 degree plug.
 To complete part number see how to order on page 25.

| Shell Size | Recept. Front View | | Receptacle Side View | | | | | | Class "A", | | | | |
|------------|--------------------|------------|----------------------|---------------------|-----------|---------------------|-------------------------|-----------|------------|-----------|-----------|------------------------|--|
| | S ±.020 | Y ±.020 | A +.001 -.005 | K +.020 -.010 | L Max. | M +.016 -.000 | Q Thread Class 2A | Z Max. | D Min. | L Max. | N Max. | V Thread Class A | |
| 6 | .688 | .812 | .348 | .494 | .906 | .400 | .3125-32 NEF | .948 | .175 | 1.553 | .462 | .3750-32 NEF | |
| 8 | .812 | .938 | .473 | .494 | .906 | .400 | .4375-28 UNEF | .948 | .297 | 1.553 | .590 | .5000-28 UNEF | |
| 10 | .938 | 1.062 | .590 | .494 | .906 | .400 | .5625-24 NEF | .948 | .421 | 1.553 | .717 | .6250-24 NEF | |
| 12 | 1.031 | 1.156 | .750 | .494 | .906 | .400 | .6875-24 NEF | .948 | .546 | 1.553 | .834 | .7500-20 UNEF | |
| 14 | 1.125 | 1.250 | .875 | .494 | .906 | .400 | .8125-20 UNEF | .948 | .663 | 1.553 | .970 | .8750-20 UNEF | |
| 16 | 1.219 | 1.344 | 1.000 | .494 | .906 | .400 | .9375-20 UNEF | .948 | .787 | 1.553 | 1.088 | 1.0000-20 UNEF | |
| 18 | 1.312 | 1.438 | 1.125 | .494 | .906 | .400 | 1.0625-18 NEF | .948 | .879 | 1.553 | 1.216 | 1.1875-18 NEF | |
| 20 | 1.438 | 1.562 | 1.250 | .650 | 1.125 | .535 | 1.1875-18 NEF | 1.166 | 1.041 | 1.703 | 1.332 | 1.1875-18 NEF | |
| 22 | 1.562 | 1.688 | 1.375 | .650 | 1.125 | .535 | 1.3125-18 NEF | 1.166 | 1.135 | 1.703 | 1.460 | 1.4375-18 NEF | |
| 24 | 1.688 | 1.812 | 1.500 | .683 | 1.188 | .568 | 1.4375-18 NEF | 1.166 | 1.259 | 1.765 | 1.585 | 1.4375-18 NEF | |

| Shell Size | Class "A" (SR), "E" (SR), "P" (SR), MS/"F" | | | | | | Class "E", MS/"E" | | Class "P", MS/"P" | | | Class "J" | | | | Class "PG" | |
|------------|--|-----------|-----------|-----------|-----------|-----------|-------------------|-----------|-------------------|-----------|-----------|-----------|------|-----------|------------|-------------|-----------|
| | C Thread | D Min. | G Max. | H Max. | L Max. | N Max. | L Max. | N Max. | D Min. | L Max. | N Max. | D | | N Max. | XL Max. | B Thread | L Max. |
| 6 | - | - | - | - | - | - | 1.266 | .440 | .192 | 1.438 | .484 | - | - | - | - | - | - |
| 8 | 6-32 | .240 | .125 | .812 | 1.922 | .550 | 1.266 | .560 | .317 | 1.438 | .608 | .168 | .230 | .547 | 2.271 | M12x1.5-6H | .936 |
| 10 | 6-32 | .302 | .188 | .875 | 1.922 | .675 | 1.266 | .685 | .434 | 1.438 | .734 | .205 | .312 | .675 | 2.271 | M16x1.5-6H | .936 |
| 12 | 6-32 | .428 | .312 | 1.000 | 1.922 | .803 | 1.266 | .813 | .548 | 1.438 | .858 | .338 | .442 | .812 | 2.411 | M16x1.5-6H | .936 |
| 14 | 6-32 | .552 | .375 | 1.125 | 1.922 | .920 | 1.266 | .930 | .673 | 1.438 | .984 | .416 | .539 | .940 | 2.599 | M18x1.5-6H | .936 |
| 16 | 6-32 | .615 | .500 | 1.188 | 2.047 | 1.047 | 1.266 | 1.057 | .798 | 1.438 | 1.110 | .550 | .616 | 1.067 | 2.943 | M22x1.5-6H | .936 |
| 18 | 8-32 | .740 | .625 | 1.438 | 2.078 | 1.165 | 1.266 | 1.175 | .899 | 1.438 | 1.234 | .600 | .672 | 1.194 | 3.172 | M25x1.5-6H | .936 |
| 20 | 8-32 | .740 | .625 | 1.438 | 2.344 | 1.290 | 1.516 | 1.301 | 1.024 | 1.656 | 1.360 | .635 | .747 | 1.322 | 3.610 | M25x1.5-6H | 1.180 |
| 22 | 8-32 | .928 | .750 | 1.625 | 2.344 | 1.418 | 1.516 | 1.430 | 1.149 | 1.656 | 1.484 | .670 | .846 | 1.449 | 3.766 | M32x1.5-6H | 1.180 |
| 24 | 8-32 | .990 | .800 | 1.719 | 2.406 | 1.543 | 1.578 | 1.555 | 1.274 | 1.717 | 1.610 | .740 | .894 | 1.576 | 3.985 | M32x1.5-6H | 1.180 |

All dimensions for reference only.

PT02 (MS3112)

SP02

box mounting receptacle

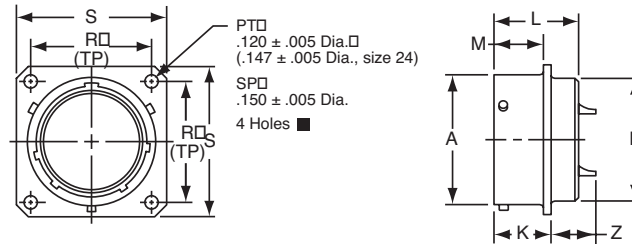

- PT02A-XX-XXX
- SP02A-XX-XXX
- * PT02C-XX-XXX
- * SP02C-XX-XXX
- * PT02E-XX-XXX
- * SP02E-XX-XXX
- MS3112E-XX-XXX
- * PT02P-XX-XXX
- * SP02P-XX-XXX
- MS3112P-XX-XXX

To complete part number see how to order on page 25.

■ (MMC) located within .0025 of (TP)

* The PT02 and SP02 box mounting receptacles are made only to complete a series; no provision is made for accessories or potting on the rear skirt.

| Shell Size | Receptacle Front View | | | | Receptacle Side View | | | | | | | | |
|------------|-----------------------|-------|-------|-------|----------------------|---------------------|------|-----------|---------------------|------|-------------------|-----------|------|
| | R (TP) | | S | | A +.001 -.005 | K +.020 -.010 | | L Max. | M +.010 -.000 | | N Dia. Max. | Z Max. | |
| | PT | SP | PT | SP | | PT | SP | | PT | SP | | PT | SP |
| 6 | .469 | .641 | .688 | .953 | .348 | .493 | .524 | .825 | .431 | .462 | .323 | .465 | .438 |
| 8 | .594 | .734 | .812 | 1.047 | .473 | .493 | .524 | .825 | .431 | .462 | .449 | .465 | .438 |
| 10 | .719 | .812 | .938 | 1.125 | .590 | .493 | .524 | .825 | .431 | .462 | .573 | .465 | .438 |
| 12 | .812 | .938 | 1.031 | 1.250 | .750 | .493 | .524 | .825 | .431 | .462 | .699 | .465 | .438 |
| 14 | .906 | 1.031 | 1.125 | 1.344 | .875 | .493 | .524 | .825 | .431 | .462 | .823 | .465 | .438 |
| 16 | .969 | 1.125 | 1.219 | 1.438 | 1.000 | .493 | .524 | .825 | .431 | .462 | .949 | .465 | .438 |
| 18 | 1.062 | 1.203 | 1.312 | 1.516 | 1.125 | .493 | .524 | .825 | .431 | .462 | 1.073 | .465 | .438 |
| 20 | 1.156 | 1.297 | 1.438 | 1.672 | 1.250 | .650 | .650 | 1.076 | .556 | .556 | 1.199 | .526 | .531 |
| 22 | 1.250 | 1.375 | 1.562 | 1.750 | 1.375 | .650 | .650 | 1.076 | .556 | .556 | 1.323 | .526 | .531 |
| 24 | 1.375 | 1.500 | 1.688 | 1.875 | 1.500 | .683 | .683 | 1.109 | .589 | .589 | 1.449 | .493 | .497 |

All dimensions for reference only.

PT06 (MS3116)

SP06

straight plug

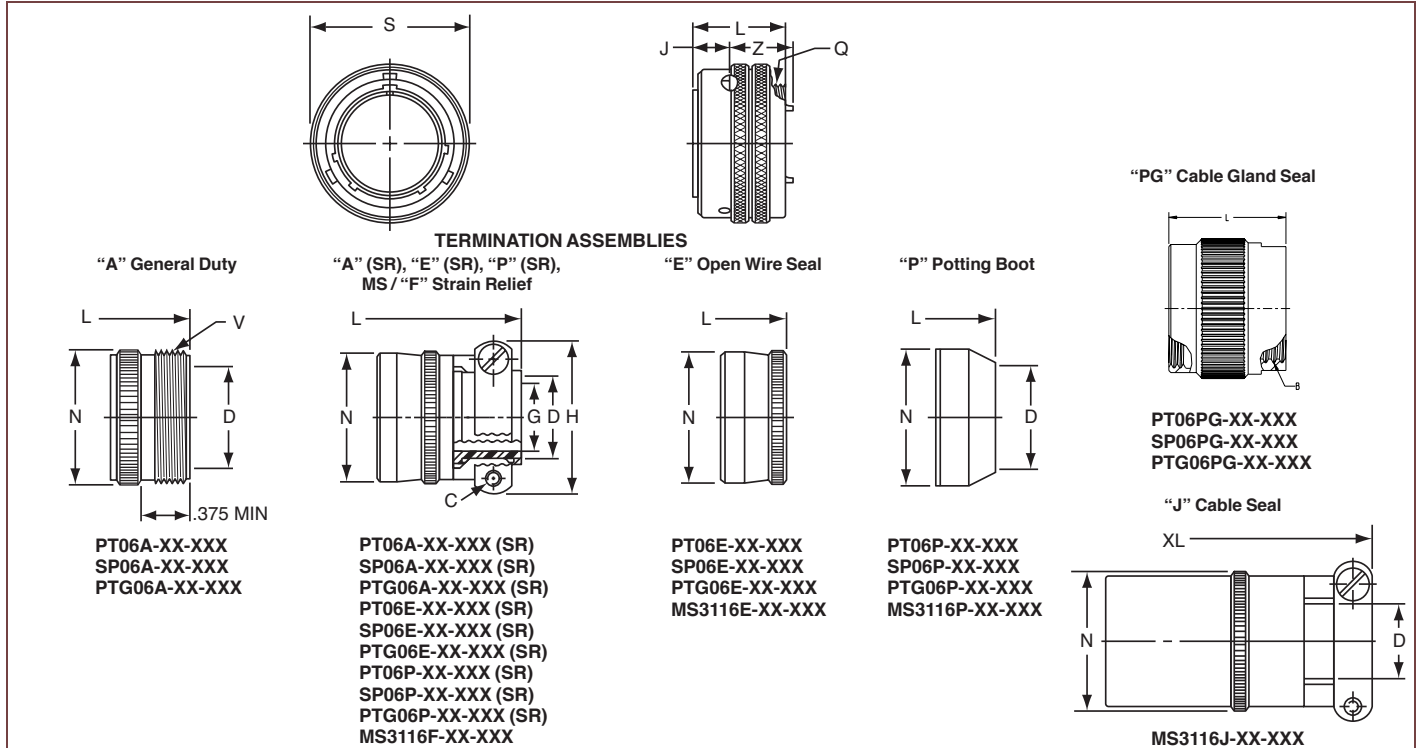

To complete part number see how to order on page 25.

| Shell Size | Plug Front View | | Plug Side View | | | | Class "A" | | | |
|------------|-----------------|--|----------------|--------|-------------------|--------|-----------|--------|--------|------------------|
| | S Max. | | J | L Max. | Q Thread Class 2A | Z Max. | D Min. | L Max. | N Max. | V Thread Class A |
| 6 | .625 | | .353 | .906 | .3125-32 NEF | .594 | .175 | 1.609 | .462 | .3750-32 NEF |
| 8 | .750 | | .353 | .906 | .4375-28 UNEF | .594 | .297 | 1.609 | .590 | .5000-28 UNEF |
| 10 | .859 | | .353 | .906 | .5625-24 NEF | .594 | .421 | 1.609 | .717 | .6250-24 NEF |
| 12 | 1.013 | | .353 | .906 | .6875-24 NEF | .594 | .546 | 1.609 | .834 | .7500-20 UNEF |
| 14 | 1.156 | | .353 | .906 | .8125-20 UNEF | .594 | .663 | 1.609 | .970 | .8750-20 UNEF |
| 16 | 1.281 | | .353 | .906 | .9375-20 UNEF | .594 | .787 | 1.609 | 1.088 | 1.0000-20 UNEF |
| 18 | 1.319 | | .353 | .906 | 1.0625-18 NEF | .594 | .879 | 1.609 | 1.216 | 1.1875-18 NEF |
| 20 | 1.531 | | .415 | 1.062 | 1.1875-18 NEF | .672 | 1.014 | 1.656 | 1.332 | 1.1875-18 NEF |
| 22 | 1.656 | | .415 | 1.062 | 1.3125-18 NEF | .672 | 1.135 | 1.656 | 1.460 | 1.4375-18 NEF |
| 24* | 1.776 | | .415 | 1.125 | 1.4375-18 NEF | .672 | 1.259 | 1.750 | 1.587 | 1.4375-18 NEF |

| Shell Size | Class "A" (SR), "E" (SR), "P" (SR), MS/"F" | | | | | | | Class "E", MS/"E" | | | Class "P", MS/"P" | | | Class "J" | | Class "PG" | |
|------------|--|--------|--------|--------|--------|--------|--------|-------------------|--------|--------|-------------------|------|------|-----------|---------|------------|--------|
| | C Thread | D Min. | G Max. | H Max. | L Max. | N Max. | L Max. | N Max. | D Min. | L Max. | N Max. | D | | N Max. | XL Max. | B Thread | L Max. |
| 6 | - | - | - | - | - | - | 1.266 | .440 | .192 | 1.438 | .484 | - | - | - | - | - | - |
| 8 | 6-32 | .240 | .125 | .812 | 1.922 | .550 | 1.266 | .560 | .317 | 1.438 | .608 | .168 | .230 | .547 | 2.271 | M12x1.5-6H | .936 |
| 10 | 6-32 | .302 | .188 | .875 | 1.922 | .675 | 1.266 | .685 | .434 | 1.438 | .734 | .205 | .312 | .675 | 2.271 | M16x1.5-6H | .936 |
| 12 | 6-32 | .428 | .312 | 1.000 | 1.922 | .803 | 1.266 | .813 | .548 | 1.438 | .858 | .338 | .442 | .812 | 2.411 | M16x1.5-6H | .936 |
| 14 | 6-32 | .552 | .375 | 1.125 | 1.922 | .920 | 1.266 | .930 | .673 | 1.438 | .984 | .416 | .539 | .940 | 2.599 | M18x1.5-6H | .936 |
| 16 | 6-32 | .615 | .500 | 1.188 | 2.047 | 1.047 | 1.266 | 1.057 | .798 | 1.438 | 1.110 | .550 | .616 | 1.067 | 2.943 | M22x1.5-6H | .936 |
| 18 | 8-32 | .740 | .625 | 1.438 | 2.078 | 1.165 | 1.266 | 1.175 | .899 | 1.438 | 1.234 | .600 | .672 | 1.194 | 3.172 | M25x1.5-6H | .936 |
| 20 | 8-32 | .740 | .625 | 1.438 | 2.344 | 1.290 | 1.516 | 1.301 | 1.024 | 1.656 | 1.360 | .635 | .747 | 1.322 | 3.610 | M25x1.5-6H | 1.180 |
| 22 | 8-32 | .928 | .750 | 1.625 | 2.344 | 1.418 | 1.516 | 1.430 | 1.149 | 1.656 | 1.484 | .670 | .846 | 1.449 | 3.766 | M32x1.5-6H | 1.180 |
| 24 | 8-32 | .990 | .800 | 1.719 | 2.406 | 1.543 | 1.578 | 1.555 | 1.274 | 1.717 | 1.610 | .740 | .894 | 1.576 | 3.985 | M32x1.5-6H | 1.180 |

All dimensions for reference only.

PT07 (MS3114) SP07 jam nut receptacle

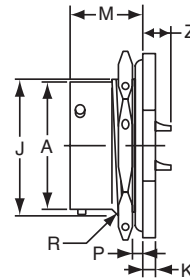
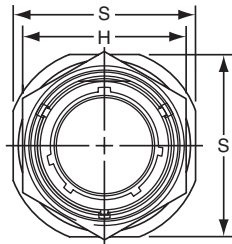

"A" General Duty/
"C" Pressurized Receptacle
PT07A-XX-XXX
PT07C-XX-XXX

TERMINATION ASSEMBLIES

"A" (SR), "E" (SR), "P" (SR), MS / "F" Strain Relief

"E" Open Wire Seal

"P" Potting Boot

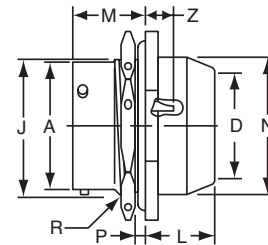
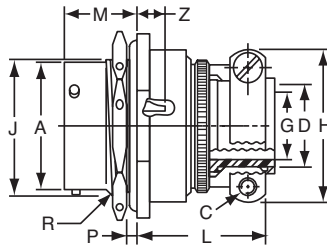
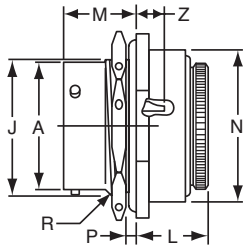

PT07E-XX-XXX
SP07E-XX-XXX
MS3114E-XX-XXX

PT07A-XX-XXX (SR)
SP07A-XX-XXX (SR)
PT07E-XX-XXX (SR)
MS3114F-XX-XXX

PT07P-XX-XXX
MS3114P-XX-XXX

To complete part number see how to order on page 25.

| Shell Size | Recept. Front View | | Receptacle Side View | | | | | | | Class "E", MS / "E" | | | | |
|------------|--------------------|-------|--------------------------|--------------------------|---------------------|-------------------|------|---------------------------|-----------|---------------------|------|--------|------------|------|
| | H ±.016 | S | A Dia. +.001 -.005 | J Flat +.000 -.010 | K +.011 -.010 | P Panel Thickness | | R Thread Class 2A UNEF | Z | L Max. | M | N Max. | Z ±.040 | |
| 6 | .625 | .812 | .348 | .405 | .125 | .696 | .062 | .125 | .4375-28 | .231 | .568 | .696 | .604 | .191 |
| 8 | .750 | .938 | .473 | .530 | .125 | .696 | .062 | .125 | .5625-24 | .231 | .568 | .696 | .729 | .191 |
| 10 | .875 | 1.062 | .590 | .655 | .125 | .696 | .062 | .125 | .6875-24 | .231 | .568 | .696 | .854 | .191 |
| 12 | 1.062 | 1.250 | .750 | .818 | .125 | .696 | .062 | .125 | .8750-20 | .231 | .568 | .696 | .979 | .191 |
| 14 | 1.188 | 1.375 | .875 | .942 | .125 | .696 | .062 | .125 | 1.0000-20 | .231 | .568 | .696 | 1.104 | .191 |
| 16 | 1.312 | 1.500 | 1.000 | 1.066 | .125 | .696 | .062 | .125 | 1.1250-18 | .231 | .568 | .696 | 1.229 | .191 |
| 18 | 1.438 | 1.625 | 1.125 | 1.191 | .125 | .696 | .062 | .125 | 1.2500-18 | .231 | .568 | .696 | 1.354 | .191 |
| 20 | 1.562 | 1.812 | 1.250 | 1.316 | .156 | .884 | .062 | .250 | 1.3750-18 | .261 | .630 | .884 | 1.510 | .221 |
| 22 | 1.688 | 1.938 | 1.375 | 1.441 | .156 | .884 | .062 | .250 | 1.5000-18 | .261 | .630 | .884 | 1.635 | .221 |
| 24 | 1.816 | 2.062 | 1.500 | 1.566 | .156 | .917 | .062 | .250 | 1.6250-18 | .228 | .660 | .917 | 1.760 | .188 |

| Shell Size | Class "A" (SR), "P" (SR), MS / "F" | | | | | | Class "E" (SR) | | | | | | Class "P", MS / "P" | | | | |
|------------|------------------------------------|--------|------|-------|-------|------|----------------|--------|------|-------|-------|------|---------------------|------------------|------|-------|------|
| | C Thread | D Max. | G | H | L | M | C Thread | D Max. | G | H | L | M | D Max. | L +.010 -.026 | M | N | Z |
| 6 | - | - | - | - | - | - | - | - | - | - | - | - | .202 | .593 | .696 | .484 | .191 |
| 8 | 6-32 | .250 | .125 | .781 | 1.062 | .696 | 6-32 | .250 | .125 | .775 | 1.029 | .696 | .327 | .593 | .696 | .608 | .191 |
| 10 | 6-32 | .312 | .188 | .844 | 1.062 | .696 | 6-32 | .312 | .188 | .837 | 1.029 | .696 | .444 | .593 | .696 | .734 | .191 |
| 12 | 6-32 | .438 | .312 | .969 | 1.062 | .696 | 6-32 | .438 | .312 | .963 | 1.029 | .696 | .558 | .593 | .696 | .858 | .191 |
| 14 | 6-32 | .562 | .375 | 1.094 | 1.062 | .696 | 6-32 | .562 | .375 | 1.087 | 1.029 | .696 | .683 | .593 | .696 | .984 | .191 |
| 16 | 6-32 | .625 | .500 | 1.156 | 1.188 | .696 | 6-32 | .625 | .500 | 1.150 | 1.161 | .696 | .808 | .593 | .696 | 1.110 | .191 |
| 18 | 8-32 | .750 | .625 | 1.406 | 1.188 | .696 | 8-32 | .750 | .625 | 1.400 | 1.161 | .696 | .909 | .593 | .696 | 1.234 | .191 |
| 20 | 8-32 | .750 | .625 | 1.406 | 1.250 | .884 | 8-32 | .750 | .625 | 1.400 | 1.224 | .884 | 1.034 | .718 | .884 | 1.360 | .221 |
| 22 | 8-32 | .938 | .750 | 1.594 | 1.250 | .884 | 8-32 | .938 | .750 | 1.587 | 1.224 | .884 | 1.159 | .718 | .884 | 1.484 | .221 |
| 24* | 8-32 | 1.000 | .800 | 1.594 | 1.250 | .917 | 8-32 | 1.000 | .800 | 1.681 | 1.320 | .917 | 1.284 | .718 | .917 | 1.610 | .188 |

* Size 24 strain relief available in PT only.

All dimensions for reference only.

PT08 E

SP08 E

90 degree plug

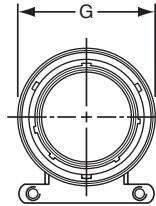

TERMINATION ASSEMBLIES

“E” Open Wire Seal, “E” (SR) Strain Relief

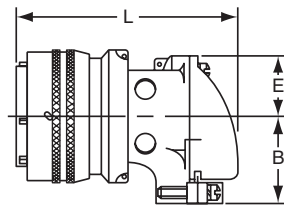

PT08E-XX-XXX
 SP08E-XX-XXX
 PT08E-XX-XXX (SR)
 SP08E-XX-XXX (SR)

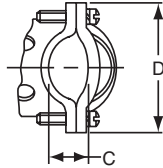

“P” Potting Boot 75 degrees

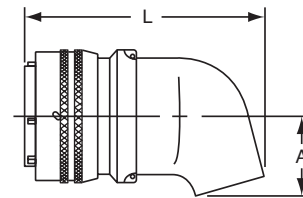

PT08P-XX-XXX
 SP08P-XX-XXX

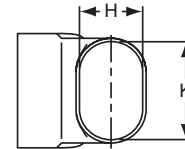

To complete part number see how to order on page 25.
 All lockwire holes are .044 Dia. Min.

| Shell Size | Plug Front View | | Plug Side View | | | | | | | |
|------------|-----------------|---------|---------------------|---------|----------------|---------|-----------|---------|---------|--------|
| | G Dia. Max. | B ±.031 | Class “E”, “E” (SR) | | | | Class “P” | | | |
| | | | C +.010 - .025 | D ±.062 | E +.047 - .025 | L ±.057 | A ±.025 | H ±.015 | K ±.015 | L Max. |
| 8 | .796 | .655 | .169 | .941 | .339 | 1.786 | .469 | .312 | .438 | 1.656 |
| 10 | .921 | .749 | .170 | 1.191 | .393 | 1.880 | .547 | .438 | .562 | 1.781 |
| 12 | 1.046 | .812 | .264 | 1.191 | .450 | 1.965 | .625 | .516 | .688 | 1.843 |
| 14 | 1.171 | .905 | .310 | 1.254 | .519 | 2.113 | .734 | .625 | .781 | 1.953 |
| 16 | 1.297 | 1.030 | .330 | 1.316 | .583 | 2.315 | .750 | .656 | .890 | 2.000 |
| 18 | 1.422 | 1.015 | .444 | 1.562 | .621 | 2.423 | .781 | .703 | 1.000 | 2.046 |
| 20 | 1.562 | 1.077 | .510 | 1.625 | .683 | 2.695 | .859 | .766 | 1.125 | 2.218 |
| 22 | 1.672 | 1.139 | .515 | 1.719 | .739 | 2.742 | .906 | .812 | 1.234 | 2.265 |
| 24 | 1.797 | 1.265 | .656 | 1.751 | .797 | 2.980 | 1.169 | .918 | 1.374 | 2.624 |

All dimensions for reference only.

PT Connectors with Printed Circuit Board Contacts

Box Mounting Receptacle (PT02) with PCB Contacts

Order by applicable part number in chart below; add insert arrangement number. Refer to insert availability on pages 4-10.

■ (MMC) located within .0025 of (TP)

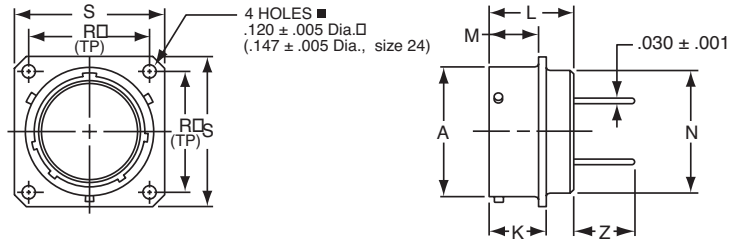

| Shell Size | Part Number* PT02 with PCB Contacts | Receptacle Front View | | Receptacle Side View | | | | | |
|------------|--|-----------------------|---------------------|----------------------|---------------------|-----------|---------------------|-------------------|---------------------|
| | | R (TP) | S +.011 -.010 | A +.001 -.005 | K +.021 -.010 | L Max. | M +.010 -.000 | N Dia. Max. | Z +.040 -.050 |
| 6 | 71-570120-XXX | .469 | .688 | .348 | .493 | .825 | .431 | .323 | .380 |
| 8 | 71-570121-XXX | .594 | .812 | .473 | .493 | .825 | .431 | .449 | .380 |
| 10 | 71-570122-XXX | .719 | .938 | .590 | .493 | .825 | .431 | .573 | .380 |
| 12 | 71-570123-XXX | .812 | 1.031 | .750 | .493 | .825 | .431 | .699 | .380 |
| 14 | 71-570124-XXX | .906 | 1.125 | .875 | .493 | .825 | .431 | .823 | .380 |
| 16 | 71-570125-XXX | .969 | 1.219 | 1.000 | .493 | .825 | .431 | .949 | .380 |
| 18 | 71-570126-XXX | 1.062 | 1.312 | 1.125 | .493 | .825 | .431 | 1.073 | .380 |
| 20 | 71-570127-XXX | 1.156 | 1.438 | 1.250 | .650 | 1.076 | .556 | 1.199 | .286 |
| 22 | 71-570128-XXX | 1.250 | 1.562 | 1.375 | .650 | 1.076 | .556 | 1.323 | .286 |
| 24 | 71-570129-XXX | 1.375 | 1.688 | 1.500 | .683 | 1.109 | .589 | 1.449 | .253 |

All dimensions for reference only.

Jam Nut Receptacle (PT07) with PCB Contacts

All lockwire holes are .044 Dia. Min.

Order by applicable part number in chart below; add insert arrangement number. Refer to insert availability on pages 4-10.

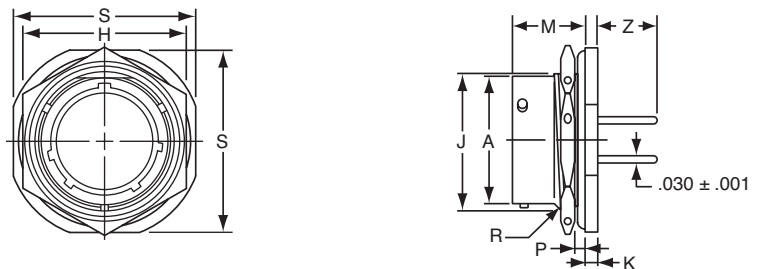

| Shell Size | Part Number* PT07 with PCB Contacts | Receptacle Front View | | Receptacle Side View | | | | | | | |
|------------|--|-----------------------|------------|--------------------------|--------------------------|---------------------|------------|-------------------|------|-------------------------|---------------------|
| | | H +.017 -.016 | S ±.010 | A Dia. +.001 -.005 | J Flat +.000 -.010 | K +.011 -.010 | M ±.010 | P Panel Thickness | | R Thread Class 2A | Z +.025 -.035 |
| | | | | | | | Min. | Max. | | | |
| 6 | 71-533720-XXX | .625 | .812 | .348 | .405 | .125 | .696 | .062 | .125 | .4375-28 UNEF | .376 |
| 8 | 71-533721-XXX | .750 | .938 | .473 | .530 | .125 | .696 | .062 | .125 | .5625-24 UNEF | .376 |
| 10 | 71-533722-XXX | .875 | 1.062 | .590 | .655 | .125 | .696 | .062 | .125 | .6875-24 UNEF | .376 |
| 12 | 71-533723-XXX | 1.062 | 1.250 | .750 | .818 | .125 | .696 | .062 | .125 | .8750-20 UNEF | .376 |
| 14 | 71-533724-XXX | 1.188 | 1.375 | .875 | .942 | .125 | .696 | .062 | .125 | 1.0000-20 UNEF | .376 |
| 16 | 71-533725-XXX | 1.312 | 1.500 | 1.000 | 1.066 | .125 | .696 | .062 | .125 | 1.1250-18 UNEF | .376 |
| 18 | 71-533726-XXX | 1.438 | 1.625 | 1.125 | 1.191 | .125 | .696 | .062 | .125 | 1.2500-18 UNEF | .376 |
| 20 | 71-533727-XXX | 1.562 | 1.812 | 1.250 | 1.316 | .156 | .884 | .062 | .250 | 1.3750-18 UNEF | .367 |
| 22 | 71-533728-XXX | 1.688 | 1.938 | 1.375 | 1.441 | .156 | .884 | .062 | .250 | 1.5000-18 UNEF | .367 |
| 24 | 71-533729-XXX | 1.816 | 2.062 | 1.500 | 1.566 | .156 | .917 | .062 | .250 | 1.6250-18 UNEF | .334 |

All dimensions for reference only.

* For RoHS compliance connectors with PCB contacts change "71" to:
 "FL" designates conductive gray zinc nickel plating
 "93" designates black zinc cobalt plating

PTB SPB

thru bulkhead receptacle

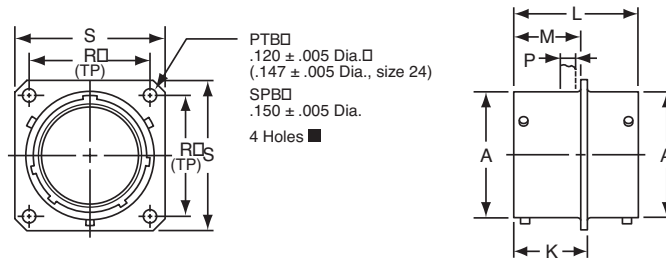

* PTB-XX-XXX
* SPB-XX-XXX

* To complete part number add desired arrangement number (refer to pages 4 and 5 for insert availability) and add "PS";
Example: PTB-18-32PS. If a rotation is required, use PTB-18-32PS and add W, X, Y or Z. Example: PTB-18-32PSW.
The socket end of the insert always appears at the "P" dimension end of shell.

■ (MMC) located within .0025 of (TP)

| Shell Size | Receptacle Front View | | | | Receptacle Side View | | | | | |
|---------------|-----------------------|-------|-------|-------|----------------------|---------------------|------------|---------------------|-----------|------|
| | R (TP) | | S | | A +.001 -.005 | K +.016 -.000 | L ±.005 | M +.010 -.000 | P Max. | |
| | PTB | SPB | PTB | SPB | | | | | PTB | SPB |
| 6 | .469 | .641 | .688 | .953 | .348 | .625 | 1.050 | .562 | .125 | .188 |
| 8 | .594 | .734 | .812 | 1.047 | .473 | .625 | 1.050 | .562 | .125 | .188 |
| 10 | .719 | .812 | .938 | 1.125 | .590 | .625 | 1.050 | .562 | .125 | .188 |
| 12 | .812 | .938 | 1.031 | 1.250 | .750 | .625 | 1.050 | .562 | .125 | .188 |
| 14 | .906 | 1.031 | 1.125 | 1.344 | .875 | .625 | 1.050 | .562 | .125 | .188 |
| 16 | .969 | 1.125 | 1.219 | 1.438 | 1.000 | .625 | 1.050 | .562 | .125 | .188 |
| 18 | 1.062 | 1.203 | 1.312 | 1.516 | 1.125 | .625 | 1.050 | .562 | .125 | .188 |
| 20 | 1.156 | 1.297 | 1.438 | 1.672 | 1.250 | .781 | 1.330 | .688 | .125 | .312 |
| 22 | 1.250 | 1.375 | 1.562 | 1.750 | 1.375 | .781 | 1.330 | .688 | .125 | .312 |
| 24 | 1.375 | 1.500 | 1.688 | 1.875 | 1.500 | .781 | 1.330 | .688 | .125 | .312 |

All dimensions for reference only.

PT hermetic

solder
mounting
receptacle



box
mounting
receptacle

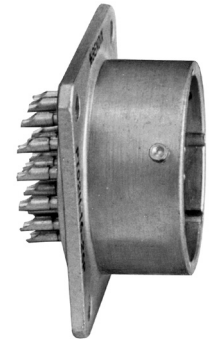

jam nut
receptacle

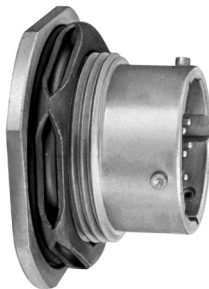

Three shell styles are available in the hermetic PT bayonet series:

- PTIH (MS3113H)
- PT02H
- PT07H (MS3114H)

These hermetic connectors are only available with solder cup or flat eyelet pin contacts in the MS/PT version. Socket contacts are available in some proprietary PT versions. Other design characteristics of the PT hermetic connector series are as follows:

Shell sizes: 8 through 24 (tin plated)

Contact count: 2 through 61. Refer to pages 4 and 5 for insert availability for hermetics.

Current: 5.0 amp each #20 contact
10 amp each #16 contact
17 amp each #12 contact

Contacts are tin plated for PT; gold is optional

Dielectric Withstanding Voltage (sea level):
1500 volts (RMS) 60 cps, Service Rating I
2300 volts (RMS) 60 cps, Service Rating II

Compression glass inserts, permanently lettered

Helium Leakage: Less than 1.0×10^{-6} cc/sec.
at 15 psi differential

Physical Shock: 100 G's

Vibration: Exceeds MIL-E-5272 Procedure II

Thermal Shock: No deterioration or failure after 5 cycles
at -55°F to $+257^{\circ}\text{F}$

Intermateability: Mates with MS3116 and PT06

Refer to pages 4-10 for insert arrangement availability.

PTIH (MS3113H)

hermetic solder mounting receptacle

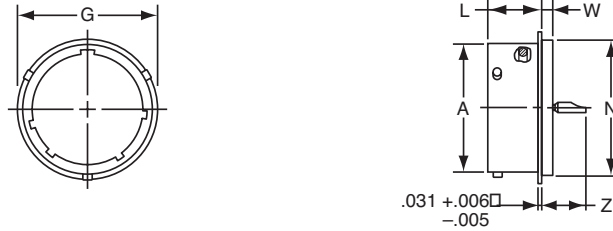

- * PTIH-XX-XXX
- ** PTIY-XX-XXX
- ** MS3113H-XXCXXX
- † PTIH-XX-XXX (100)
- †† PTIY-XX-XXX (100)
- †† MS3113H-XXYXXX

To complete part number see how to order on page 25.

- * Solder cup pin contacts without interfacial seal
- ** Solder cup pin contacts with interfacial seal
- † Flat eyelet pin contacts without interfacial seal
- †† Flat eyelet pin contacts with interfacial seal

| Shell Size | Recept. Front View | Receptacle Side View | | | | |
|------------|--------------------|----------------------|----------------|---------------------|----------------|--------|
| | G Dia. Max. | A Dia. +.001 - .005 | L +.025 - .016 | N Dia. +.001 - .005 | W +.011 - .010 | Z Max. |
| 6 | .511 | .348 | .447 | .438 | .094 | .386 |
| 8 | .636 | .473 | .447 | .562 | .094 | .386 |
| 10 | .761 | .590 | .447 | .672 | .094 | .386 |
| 12 | .855 | .750 | .447 | .781 | .094 | .386 |
| 14 | .980 | .875 | .447 | .906 | .094 | .386 |
| 16 | 1.105 | 1.000 | .447 | 1.031 | .094 | .386 |
| 18 | 1.229 | 1.125 | .447 | 1.156 | .094 | .386 |
| 20 | 1.323 | 1.250 | .509 | 1.250 | .094 | .386 |
| 22 | 1.449 | 1.375 | .509 | 1.375 | .125 | .418 |
| 24 | 1.574 | 1.500 | .542 | 1.500 | .125 | .418 |

All dimensions for reference only.

PT02H

hermetic box mounting receptacle

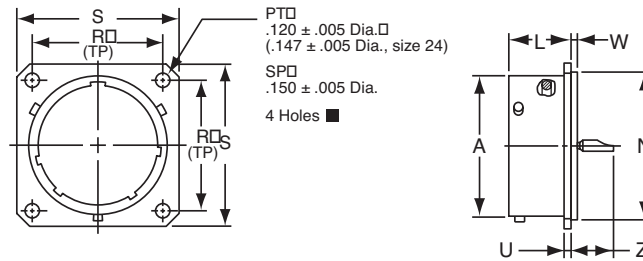

- * PT02H-XX-XXX
- ** PT02Y-XX-XXX
- † PT02H-XX-XXX (100)
- †† PT02Y-XX-XXX (100)

To complete part number see how to order on page 25.

* Solder cup pin contacts without interfacial seal

** Solder cup pin contacts with interfacial seal

† Flat eyelet pin contacts without interfacial seal

†† Flat eyelet pin contacts with interfacial seal

■ (MMC) located within .0025 of (TP)

| Shell Size | Receptacle Front View | | Receptacle Side View | | | | | |
|------------|-----------------------|---------|----------------------|---------|----------------|---------------------|----------------|--------|
| | R (TP) | S ±.016 | A Dia. +.001 - .005 | K ±.015 | L +.025 - .015 | N Dia. +.001 - .005 | U +.011 - .010 | Z Max. |
| 6 | .469 | .688 | .348 | .047 | .494 | .438 | .062 | .344 |
| 8 | .594 | .812 | .473 | .047 | .494 | .562 | .062 | .344 |
| 10 | .719 | .938 | .590 | .047 | .494 | .672 | .062 | .344 |
| 12 | .812 | 1.031 | .750 | .047 | .494 | .781 | .062 | .344 |
| 14 | .906 | 1.125 | .875 | .047 | .494 | .906 | .062 | .344 |
| 16 | .969 | 1.219 | 1.000 | .047 | .494 | 1.031 | .062 | .344 |
| 18 | 1.062 | 1.312 | 1.125 | .047 | .494 | 1.156 | .062 | .344 |
| 20 | 1.156 | 1.438 | 1.250 | .047 | .556 | 1.250 | .062 | .344 |
| 22 | 1.250 | 1.562 | 1.375 | .079 | .556 | 1.375 | .062 | .377 |
| 24 | 1.375 | 1.688 | 1.500 | .079 | .588 | 1.500 | .062 | .377 |

All dimensions for reference only.

PT07H (MS3114H)

hermetic jam nut receptacle

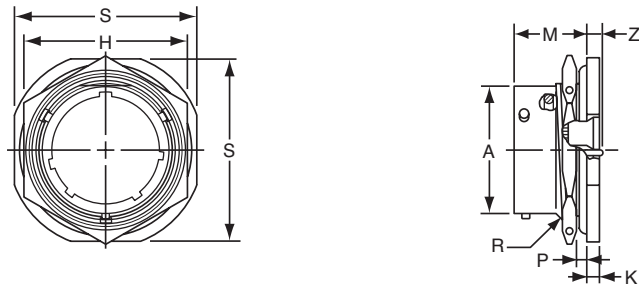

- * PT07H-XX-XXX
- ** PT07Y-XX-XXX
- ** MS3114H-XXCXXX
- † PT07H-XX-XXX (100)
- †† PT07Y-XX-XXX (100)
- †† MS3114H-XXYXXX

To complete part number see how to order on page 25.

- * Solder cup pin contacts without interfacial seal
- ** Solder cup pin contacts with interfacial seal
- † Flat eyelet pin contacts without interfacial seal
- †† Flat eyelet pin contacts with interfacial seal

| Shell Size | Receptacle Front View | | Receptacle Side View | | | | | | |
|------------|-----------------------|-------------------------|----------------------|---------------------|---------------------|-------------------|------|-------------------------|-----------|
| | S +.016 | H Hex +.017 -.016 | A +.001 -.005 | K +.043 -.016 | M +.031 -.000 | P Panel Thickness | | R Thread Class 2A | Z Max. |
| | | | | | | Max. | Min. | | |
| 6 | .812 | .625 | .348 | .094 | .696 | .125 | .062 | .4375-28 UNEF | .206 |
| 8 | .938 | .750 | .473 | .094 | .696 | .125 | .062 | .5625-24 NEF | .206 |
| 10 | 1.062 | .875 | .590 | .094 | .696 | .125 | .062 | .6875-24 NEF | .206 |
| 12 | 1.250 | 1.062 | .750 | .094 | .696 | .125 | .062 | .8750-20 UNEF | .206 |
| 14 | 1.375 | 1.188 | .875 | .094 | .696 | .125 | .062 | 1.0000-20 UNEF | .206 |
| 16 | 1.500 | 1.312 | 1.000 | .094 | .696 | .125 | .062 | 1.1250-18 NEF | .206 |
| 18 | 1.625 | 1.438 | 1.125 | .094 | .696 | .125 | .062 | 1.2500-18 NEF | .206 |
| 20 | 1.812 | 1.562 | 1.250 | .125 | .884 | .250 | .062 | 1.3750-18 NEF | .081 |
| 22 | 1.938 | 1.688 | 1.375 | .125 | .884 | .250 | .062 | 1.5000-18 NEF | .081 |
| 24 | 2.062 | 1.812 | 1.500 | .125 | .917 | .250 | .062 | 1.6250-18 NEF | .048 |

All dimensions for reference only.

PT, SP, MS/PT

how to order

PT, SP

To more easily illustrate ordering procedure, part number PT00A-20-41PW(SR) is shown as follows:

| | | | | | | | | | |
|----|----|---|---|----|---|----|---|---|------|
| PT | 00 | A | - | 20 | - | 41 | P | W | (SR) |
| 1 | 2 | 3 | 4 | 5 | 6 | 7 | 8 | | |

See code below:

1. Connector Type
 - “PT” designates standard olive drab, electrically conductive cadmium plate bayonet lock connector with solder contacts
 - “SP” designates electrically non-conductive, hard anodic coated bayonet lock connector with solder contacts and larger flange and mounting holes for back panel mounting
 - “PTG” designates plug with grounding fingers
2. Shell Style
 - “00” designates wall mounting receptacle
 - “01” designates cable connecting receptacle**
 - “02” designates box mounting receptacle
 - “06” designates straight plug
 - “07” designates jam nut receptacle
 - “08” designates 90 degree plug cable support
 - “B” designates thru bulkhead receptacle (pressurized)
 - “I” designates solder mount receptacle (Hermetic only)
3. Service Classes
 - “A” designates general duty back shell
 - “C” designates pressurized receptacle
 - “E” designates environmental resisting open wire seal with grommet and nut
 - “P” designates assembly with potting boot
 - “PG” designates adapter for cable gland for moisture proofing jacketed cables
 - “H” designates hermetic* without interfacial seal
 - “Y” designates hermetic* with interfacial seal
4. Shell Size
 - “20” designates shell size. Shell sizes 6 through 24 available.
5. Insert Arrangement - Refer to pages 4-10 for insert availability.
 - “20 - 41” designates insert arrangement. (The number following the hyphen is the number only that is used in the part number).
6. Contacts
 - “P” designates pin contacts
 - “S” designates socket contacts

For ordering connectors with printed circuit board contacts, see pg. 19.
7. Insert Rotation - Refer to page 6.
 - “W”, “X”, “Y”, “Z” designate that insert is rotated in its shell from “normal position.”
 - No letter required for normal (no rotation) position.
8. “SR” designates a strain relief clamp.
 - Indicate optional finishes as follows:
 - (003) olive drab cadmium plate (standard on “PT”)
 - (100) Suffix added for flat eyelet pin contacts in hermetic versions
 - OR
 - RoHS Compliant finish suffix as follow:
 - (005) anodic coating - Alumilite® (standard on “SP”)
 - (023) electroless nickel
 - (025) black zinc cobalt plating
 - (072) conductive gray zinc nickel plating
 - (424) electroless nickel finish with strain relief
 - (470) black zinc cobalt plating with strain relief



MS/PT

MIL-DTL-26482, Series 1

Part number MS3110E20-41PW is shown as follows:

| | | | | | | | | |
|----|-----|---|---|----|---|----|---|---|
| MS | 311 | 0 | E | 20 | - | 41 | P | W |
| 1 | 2 | 3 | 4 | 5 | 6 | 7 | 8 | |

For Hermetic connectors part number MS3113H20Y-41PW is shown as follows:

| | | | | | | | | |
|----|-----|---|---|------|---|----|---|---|
| MS | 311 | 3 | H | 20 | Y | 41 | P | W |
| 1 | 2 | 3 | 4 | 5, 6 | | 7 | 8 | |

See code below:

1. “MS” designates Military Standard
2. Specification Number
 - “311” designates basic family number for MIL-DTL-26482, Series 1 solder type
3. Shell Style
 - “0” designates wall mounting receptacle
 - “1” designates cable connecting receptacle**
 - “2” designates box mounting receptacle
 - “3” designates solder mount receptacle (hermetic only)
 - “4” designates jam nut receptacle
 - “6” designates straight plug
4. Service Class
 - “E” designates environmental resisting connector
 - “F” designates environmental resisting connectors with strain relief
 - “J” designates clamp assembly for moisture proofing multi-jacketed cables, with strain relief
 - “P” designates potted type with potting boot
 - “H” designates hermetic
5. Shell Size
 - “20” designates shell size. Shell sizes 8 through 24 available.
6. Insert Arrangement - Refer to pages 4-10 for insert availability.
 - “20 - 41” designates arrangement. (The number following the hyphen is the number only that is used in the part number).
 - Hermetic version
 - “20Y41” designates insert arrangement; specify “Y” for flat eyelet pin contacts, or “C” for solder cup pin contacts
7. Contact Configuration
 - “P” designates pin contacts
 - “S” designates socket contacts
8. Insert Rotation- Refer to page 6.
 - “W”, “X”, “Y”, “Z” designate that insert is rotated in its shell from “normal” position. No letter required for normal (no rotation) position.

* Hermetic connectors are supplied with tin plated shells.

** This connector style is sometimes referred to as a cable connecting “plug”. It does, however, mate with either a straight or 90 degree plug.

Amphenol PT-SE, SP-SE, MS/PT-SE

Proprietary/MIL-DTL-26482, Series 1 bayonet coupling and crimp termination



Amphenol® SE crimp type miniature connectors provide performance and versatility needed for applications demanding high reliability and crimp removable contacts. These crimp contacts are rear insertable/front release and are held in position by an MS approved spring tower retention system.

The MS/PT-SE Series is qualified to MIL-DTL-26482, Series 1 and has all the outstanding design characteristics and quality of the PT Series.

The SP-SE Series is a modification of the PT-SE, providing special shells with a wide mounting flange for back panel mounting.

A corrosion resistant electrically conductive finish of cadmium plate with an olive drab chromate after-treatment is used on the PT-SE and MS/PT-SE. The SP-SE is given a durable non-conductive hard anodic "Alumilite"® coating which provides abrasion protection and resistance to corrosion.

****NEW**** 500 hour corrosion resistance, RoHS compliant harsh environment conductive plating. Gray Zinc over an Electroless Nickel (Gray ZnNi) base, with a Light Gun Metal Gray appearance.

Shell components for these series are aluminum. The dependable 5 key/keyway polarization with bayonet lock coupling assures positive mating with no chance of cross plugging. Spring tension provided by a wave washer in the coupling nut ensures maintenance of interfacial seal between mating halves.

Both the insert and main joint gasket are molded from resilient neoprene. This provides excellent moisture sealing at the gasket and superior electrical isolation of the contact in the insert.

Both pins and sockets are machined from a copper alloy and are gold plated. This gold plating eliminates contact corrosion and offers an indefinite shelf life. Socket contacts for these series are a closed entry design.

Breakaway style plug is available in PT-SE crimp.

The PT-SE, SP-SE and MS/PT-SE Series are intermateable and intermountable with all existing Miniature Cylindrical Series connectors.

Refer to pages 4-10 for insert arrangement availability.

* This connector style is sometimes referred to as a cable connecting "plug". It does, however, mate with either a straight or 90 degree plug.

PT-SE, SP-SE, MS/PT-SE

| Contact Specifications | | | | |
|------------------------|--------------|-------------------------|---------------------|--------------------|
| Contact Size | Test Current | Maximum Millivolt Drop† | Crimp Well Diameter | Minimum Well Depth |
| 20 | 7.5 | 55 | .049 ±.001 | .267 |
| 16 | 13.0 | 49 | .067 ±.001 | .236 |
| 12 | 23.0 | 42 | .100 ±.002 | .236 |

| Service Rating | | | | | |
|----------------|---|-------------------------------|------------|------------|-------------|
| Service Rating | Recommended Operating AC Voltage at Sea Level | Test Voltage AC (RMS), 60 cps | | | |
| | | Sea Level | 50,000 ft. | 70,000 ft. | 110,000 ft. |
| I | 600 | 1,500 | 500 | 375 | 200 |
| II | 1,000 | 2,300 | 750 | 500 | 200 |

† Silver plated wire per MIL-DTL-26482

PT-SE and SP-SE Service Classes

PT-SE and SP-SE connectors are available in the three service classes listed below.

- “SE” Open wire sealing - environmental resistant, with a nut and grommet for moisture proofing individual wires
- “SE” (SR) Strain relief clamp - environmental resistant strain relief clamp and grommet for moisture proofing individual wires; provides added wire bundle support
- “SP” Translucent nylon boot for retaining customer applied potting compounds; held in place by a threaded ring

MS/PT-SE Service Classes

MS-SE series connectors are available in the following certified service classes:

- “E” Open wire sealing - environmental resisting connectors are supplied with a multi-hole grommet and clamping nut for moisture proofing individual open wires
- “F” Environmental resistant strain relief clamp and grommet for moisture proofing individual wires; provides added wire bundle support
- “P” Potting applications - these connectors are supplied with a translucent nylon boot for retention of customer applied potting compound

“SE”,
MS / “E”
open wire seal



“SE” (SR),
MS / “F”
strain relief
clamp



“SP”,
MS / “P”
potting boot



PT00 SE (MS3120) SP00 SE wall mounting receptacle

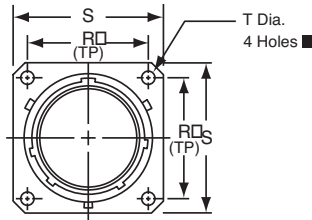

“SE” Open Wire Seal

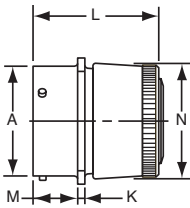

PT00SE-XX-XXX
SP00SE-XX-XXX
MS3120E-XX-XXX

TERMINATION ASSEMBLIES
“SE” (SR), MS / “F” Strain Relief

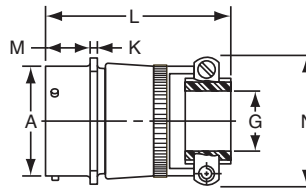

PT00SE-XX-XXX (SR)
SP00SE-XX-XXX (SR)
MS3120F-XX-XXX

“SP” Potting Boot

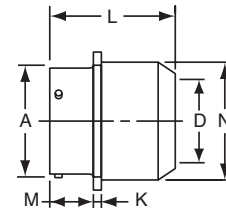

PT00SP-XX-XXX
SP00SP-XX-XXX

To complete part number see how to order on page 36.

■ (MMC) located within .005 of (TP)

| Shell Size | Receptacle Front View | | | | | | Receptacle Side View | | | | | |
|------------|-----------------------|-------|--------|-------|--------------|------|----------------------|---------|----------------|------|-------------------------|------|
| | R (TP) | | S Max. | | T Dia. ±.005 | | A Dia. +.001 - .005 | K ±.016 | M +.010 - .000 | | P* Max. Panel Thickness | |
| | PT | SP | PT | SP | PT | SP | | | PT | SP | PT | SP |
| 8 | .594 | — | .828 | — | .120 | — | .473 | .062 | .431 | — | .094 | — |
| 10 | .719 | .812 | .954 | 1.141 | .120 | .150 | .590 | .062 | .431 | .462 | .094 | .125 |
| 12 | .812 | .938 | 1.047 | 1.266 | .120 | .150 | .750 | .062 | .431 | .462 | .094 | .125 |
| 14 | .906 | 1.031 | 1.141 | 1.360 | .120 | .150 | .875 | .062 | .431 | .462 | .094 | .125 |
| 16 | .969 | 1.125 | 1.234 | 1.453 | .120 | .150 | 1.000 | .062 | .431 | .462 | .094 | .125 |
| 18 | 1.062 | 1.203 | 1.328 | 1.532 | .120 | .150 | 1.125 | .062 | .431 | .462 | .094 | .125 |
| 20 | 1.156 | 1.297 | 1.453 | 1.688 | .120 | .150 | 1.250 | .094 | .556 | .556 | .219 | .219 |
| 22 | 1.250 | 1.375 | 1.578 | 1.766 | .120 | .150 | 1.375 | .094 | .556 | .556 | .219 | .219 |
| 24 | 1.375 | 1.500 | 1.703 | 1.891 | .147 | .150 | 1.500 | .094 | .589 | .589 | .219 | .219 |

| Shell Size | Class “SE”, MS / “E” | | Class “SE” (SR), MS / “F” | | | Class “SP”, MS / “P” | | |
|------------|----------------------|-------------|---------------------------|--------|--------|----------------------|--------|-------------|
| | L Max. | N Dia. Max. | G Dia. | L Max. | N Max. | D Dia. Max. | L Max. | N Dia. Max. |
| 8 | 1.328 | .560 | .125 | 2.422 | .781 | — | — | — |
| 10 | 1.328 | .704 | .188 | 2.422 | .844 | .444 | 1.656 | .734 |
| 12 | 1.328 | .825 | .312 | 2.422 | .969 | .558 | 1.656 | .858 |
| 14 | 1.328 | .954 | .375 | 2.422 | 1.094 | .683 | 1.656 | .984 |
| 16 | 1.328 | 1.080 | .500 | 2.537 | 1.156 | .808 | 1.656 | 1.110 |
| 18 | 1.328 | 1.204 | .625 | 2.537 | 1.406 | .909 | 1.656 | 1.234 |
| 20 | 1.359 | 1.330 | .625 | 2.824 | 1.406 | 1.034 | 1.750 | 1.360 |
| 22 | 1.359 | 1.454 | .750 | 2.824 | 1.594 | 1.159 | 1.750 | 1.484 |
| 24 | 1.422 | 1.580 | .800 | 2.900 | 1.688 | 1.284 | 1.782 | 1.610 |

* Back panel mounting
All dimensions for reference only.

MF00 SE (MS3128)

wall mounting receptacle

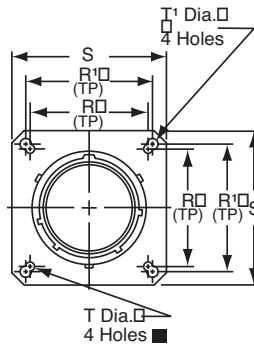

TERMINATION ASSEMBLIES

MS / "E" Open Wire Seal

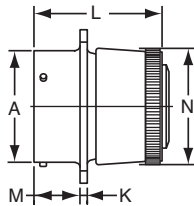

MF00SE-XX-XXX
MS3128E-XX-XXX

MS / "F" Strain Relief

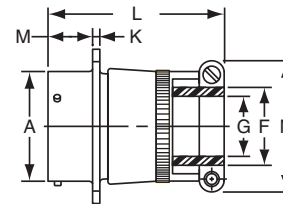

MF00SE-XX-XXX (SR)
MS3128F-XX-XXX

To complete part number see how to order on page 36.

■ (MMC) located within .0025 of (TP)

| Shell Size | Receptacle Front View | | | | | Receptacle Side View | | | | | | | | | |
|------------|-----------------------|-------|--------|--------------|---------------|----------------------|---------|----------------|----------------|--------|----------------|--------|--------|--------|--|
| | R | R' | S Max. | T Dia. ±.005 | T' Dia. ±.005 | A Dia. +.001 - .005 | K ±.016 | M +.010 - .000 | Class MS / "E" | | Class MS / "F" | | | | |
| | | | | | | | | | L Max. | N Max. | F Min. | G Dia. | L Max. | N Max. | |
| 10 | .719 | .812 | 1.141 | .120 | .150 | .590 | .062 | .462 | 1.328 | .685 | .297 | .188 | 1.906 | .891 | |
| 12 | .812 | .938 | 1.266 | .120 | .150 | .750 | .062 | .462 | 1.328 | .813 | .422 | .312 | 1.906 | 1.016 | |
| 14 | .906 | 1.031 | 1.360 | .120 | .150 | .875 | .062 | .462 | 1.328 | .930 | .547 | .375 | 1.906 | 1.141 | |
| 16 | .969 | 1.125 | 1.453 | .120 | .150 | 1.000 | .062 | .462 | 1.328 | 1.057 | .609 | .500 | 2.000 | 1.203 | |
| 18 | 1.062 | 1.203 | 1.532 | .120 | .150 | 1.125 | .062 | .462 | 1.328 | 1.175 | .734 | .625 | 2.000 | 1.469 | |
| 20 | 1.156 | 1.297 | 1.688 | .120 | .150 | 1.250 | .094 | .556 | 1.359 | 1.301 | .734 | .625 | 2.172 | 1.469 | |
| 22 | 1.250 | 1.375 | 1.766 | .120 | .150 | 1.375 | .094 | .556 | 1.359 | 1.428 | .922 | .750 | 2.172 | 1.656 | |
| 24 | 1.375 | 1.500 | 1.891 | .147 | .150 | 1.500 | .094 | .589 | 1.422 | 1.533 | .984 | .800 | 2.234 | 1.750 | |

All dimensions for reference only.

PT01 SE (MS3121) SP01 SE cable connecting receptacle

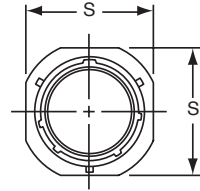

“SE”, MS / “E” Open Wire Seal

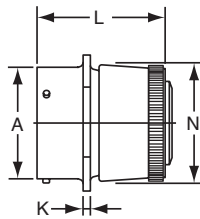

PT01SE-XX-XXX
SP01SE-XX-XXX
MS3121E-XX-XXX

TERMINATION ASSEMBLIES
“SE” (SR), MS / “F” Strain Relief

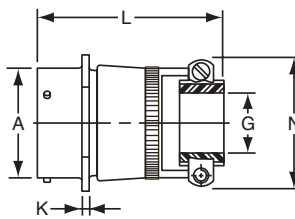

PT01SE-XX-XXX (SR)
SP01SE-XX-XXX (SR)
MS3121F-XX-XXX

“SP”, MS / “P” Potting Boot

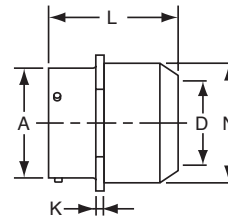

PT01SP-XX-XXX
SP01SP-XX-XXX
MS3121P-XX-XXX

Note: This connector style is sometimes referred to as a cable connecting “plug”.
It does, however, mate with either a straight or 90 degree plug.
To complete part number see how to order on page 36.

| Shell Size | Receptacle Front View | | Receptacle Side View | | | | | | | | |
|------------|-----------------------|--------------------------|----------------------|--------|-------------|---------------------------|--------|--------|----------------------|--------|-------------|
| | S Max. | A Dia. +.001 -.005 | Class “SE”, MS / “E” | | | Class “SE” (SR), MS / “F” | | | Class “SP”, MS / “P” | | |
| | | | K ±.018 | L Max. | N Dia. Max. | G Dia. | L Max. | N Max. | D Dia. | L Max. | N Dia. Max. |
| 8 | .812 | .473 | .094 | 1.522 | .560 | .125 | 2.422 | .828 | — | — | — |
| 10 | .955 | .590 | .094 | 1.522 | .685 | .188 | 2.422 | .891 | .444 | 1.656 | .734 |
| 12 | 1.048 | .750 | .094 | 1.522 | .813 | .312 | 2.422 | 1.016 | .558 | 1.656 | .858 |
| 14 | 1.142 | .875 | .094 | 1.522 | .930 | .375 | 2.422 | 1.141 | .683 | 1.656 | .984 |
| 16 | 1.236 | 1.000 | .094 | 1.522 | 1.057 | .500 | 2.537 | 1.203 | .808 | 1.656 | 1.110 |
| 18 | 1.329 | 1.125 | .094 | 1.522 | 1.175 | .625 | 2.537 | 1.469 | .909 | 1.656 | 1.234 |
| 20 | 1.455 | 1.250 | .115 | 1.709 | 1.301 | .625 | 2.824 | 1.469 | 1.034 | 1.750 | 1.360 |
| 22 | 1.579 | 1.375 | .115 | 1.709 | 1.428 | .750 | 2.824 | 1.656 | 1.159 | 1.750 | 1.484 |
| 24 | 1.709 | 1.500 | .115 | 1.709 | 1.555 | .800 | 2.900 | 1.750 | 1.284 | 1.782 | 1.610 |

All dimensions for reference only.

PT02 SE (MS3122) SP02 SE box mounting receptacle

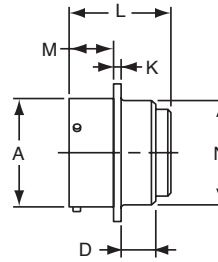
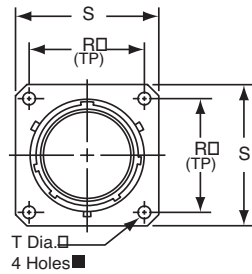

PT02SE-XX-XXX
SP02SE-XX-XXX
MS3122E-XX-XXX

To complete part number see how to order on page 36.
■ (MMC) located within .0025 of (TP)

| Shell Size | Receptacle Front View | | | | | | Receptacle Side View | | | | | | | |
|------------|-----------------------|-------|--------|-------|--------------|------|----------------------|--------|------|---------|--------|----------------|------|---------------------|
| | R | | S Max. | | T Dia. ±.005 | | A Dia. +.001 - .005 | D Max. | | K ±.016 | L Max. | M +.010 - .000 | | N Dia. +.011 - .000 |
| | PT | SP | PT | SP | PT | SP | | PT | SP | | | PT | SP | |
| 8 | .594 | - | .828 | - | .120 | - | .473 | .312 | - | .062 | 1.296 | .431 | - | .438 |
| 10 | .719 | .812 | .954 | 1.141 | .120 | .150 | .590 | .312 | .219 | .062 | 1.296 | .431 | .462 | .562 |
| 12 | .812 | .938 | 1.047 | 1.266 | .120 | .150 | .750 | .312 | .219 | .062 | 1.296 | .431 | .462 | .688 |
| 14 | .906 | 1.031 | 1.141 | 1.360 | .120 | .150 | .875 | .312 | .219 | .062 | 1.296 | .431 | .462 | .812 |
| 16 | .969 | 1.125 | 1.234 | 1.453 | .120 | .150 | 1.000 | .312 | .219 | .062 | 1.296 | .431 | .462 | .938 |
| 18 | 1.062 | 1.203 | 1.328 | 1.532 | .120 | .150 | 1.125 | .312 | .219 | .062 | 1.296 | .431 | .462 | 1.062 |
| 20 | 1.156 | 1.297 | 1.453 | 1.688 | .120 | .150 | 1.250 | .406 | .344 | .094 | 1.358 | .556 | .556 | 1.188 |
| 22 | 1.250 | 1.375 | 1.578 | 1.766 | .120 | .150 | 1.375 | .406 | .344 | .094 | 1.358 | .556 | .556 | 1.312 |
| 24 | 1.375 | 1.500 | 1.703 | 1.891 | .147 | .150 | 1.500 | .406 | .344 | .094 | 1.358 | .589 | .589 | 1.438 |

All dimensions for reference only.

MF02 SE (MS3127)

box mounting receptacle

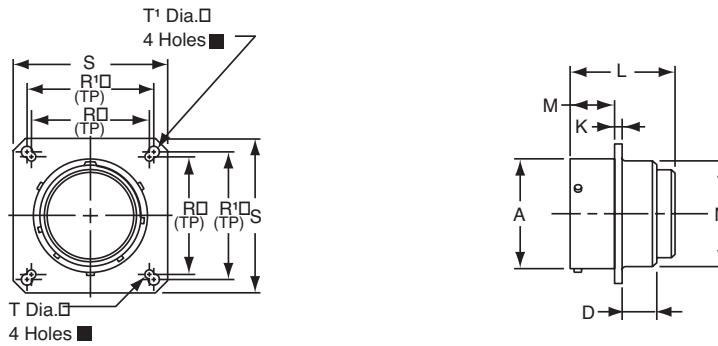

MF02SE-XX-XXX
MS3127E-XX-XXX

To complete part number see how to order on page 36.
■ (MMC) located within .0025 of (TP)

| Shell Size | Receptacle Front View | | | | | | Receptacle Side View | | | | |
|------------|-----------------------|-------|-------|--------|---------|----------|----------------------|--------|---------|--------|----------------|
| | N Dia. +.011 - .000 | R | R' | S Max. | T ±.005 | T' ±.005 | A Dia. +.001 - .005 | D Max. | K ±.016 | L Max. | M +.010 - .000 |
| 10 | .562 | .719 | .812 | 1.141 | .120 | .150 | .590 | .219 | .062 | 1.266 | .462 |
| 12 | .688 | .812 | .938 | 1.266 | .120 | .150 | .750 | .219 | .062 | 1.266 | .462 |
| 14 | .812 | .906 | 1.031 | 1.360 | .120 | .150 | .875 | .219 | .062 | 1.266 | .462 |
| 16 | .938 | .969 | 1.125 | 1.453 | .120 | .150 | 1.000 | .219 | .062 | 1.266 | .462 |
| 18 | 1.062 | 1.062 | 1.203 | 1.532 | .120 | .150 | 1.125 | .219 | .062 | 1.266 | .462 |
| 20 | 1.188 | 1.156 | 1.297 | 1.688 | .120 | .150 | 1.250 | .344 | .094 | 1.328 | .556 |
| 22 | 1.312 | 1.250 | 1.375 | 1.766 | .120 | .150 | 1.375 | .344 | .094 | 1.328 | .556 |
| 24 | 1.438 | 1.375 | 1.500 | 1.891 | .147 | .150 | 1.500 | .344 | .094 | 1.328 | .589 |

All dimensions for reference only.

PT06 SE (MS3126)

SP06 SE

straight plug

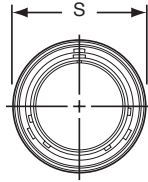

“SE”, MS / “E” Open Wire Seal

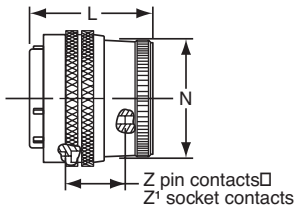

PT06SE-XX-XXX
 SP06SE-XX-XXX
 PTG06SE-XX-XXX
 MS3126E-XX-XXX

TERMINATION ASSEMBLIES
 “SE” (SR), MS / “F” Strain Relief

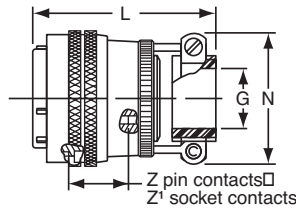

PT06SE-XX-XXX (SR)
 SP06SE-XX-XXX (SR)
 PTG06SE-XX-XXX (SR)
 MS3126F-XX-XXX

“SP”, MS / “P” Potting Boot

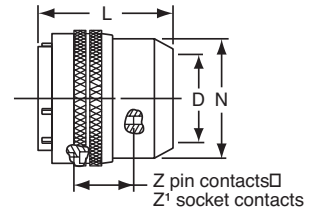

PT06SP-XX-XXX
 SP06SP-XX-XXX
 PTG06SP-XX-XXX
 MS3126P-XX-XXX

To complete part number see how to order on page 36.

| Shell Size | Plug Front View | | Plug Side View | | | | | | | | |
|------------|-----------------|---------|----------------|----------------------|--------|---------------------------|--------|--------|----------------------|--------|-------------|
| | S Dia. Max. | Z ±.045 | Z' ±.045 | Class “SE”, MS / “E” | | Class “SE” (SR), MS / “F” | | | Class “SP”, MS / “P” | | |
| | | | | L Max. | N Max. | G Dia. | L Max. | N Max. | D Dia. | L Max. | N Dia. Max. |
| 8* | .734 | .640 | .579 | 1.328 | .540 | .125 | 2.413 | .828 | .327 | 1.750 | .578 |
| 10 | .859 | .640 | .579 | 1.328 | .685 | .188 | 2.413 | .891 | .444 | 1.750 | .734 |
| 12 | 1.031 | .640 | .579 | 1.328 | .813 | .312 | 2.413 | 1.016 | .558 | 1.750 | .858 |
| 14 | 1.156 | .640 | .579 | 1.328 | .930 | .375 | 2.413 | 1.141 | .683 | 1.750 | .984 |
| 16 | 1.281 | .640 | .579 | 1.328 | 1.057 | .500 | 2.528 | 1.203 | .808 | 1.750 | 1.110 |
| 18 | 1.391 | .640 | .579 | 1.328 | 1.175 | .625 | 2.528 | 1.469 | .909 | 1.750 | 1.234 |
| 20 | 1.531 | .640 | .579 | 1.297 | 1.301 | .625 | 2.753 | 1.469 | 1.034 | 1.750 | 1.360 |
| 22 | 1.656 | .640 | .579 | 1.297 | 1.428 | .750 | 2.753 | 1.656 | 1.159 | 1.750 | 1.484 |
| 24 | 1.777 | .640 | .579 | 1.359 | 1.533 | .800 | 2.830 | 1.750 | 1.284 | 1.766 | 1.610 |

* PT-SE, MS-SE and MS-SP only.
 All dimensions for reference only.

PT07 SE (MS3124) SP07 SE jam nut receptacle

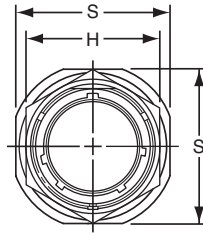

TERMINATION ASSEMBLIES
"SE" (SR), MS / "F" Strain Relief

"SE", MS / "E" Open Wire Seal

"SP", MS / "P" Potting Boot

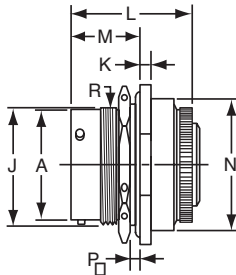

PT07SE-XX-XXX
SP07SE-XX-XXX
MS3124E-XX-XXX

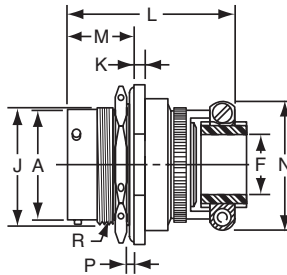

PT07SE-XX-XXX (SR)
SP07SE-XX-XXX (SR)
MS3124F-XX-XXX

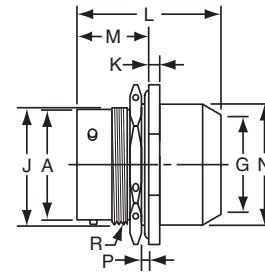

PT07SP-XX-XXX
SP07SP-XX-XXX
MS3124P-XX-XXX

To complete part number see how to order on page 36.
All lockwire holes are .044 Dia. Min.

| Shell Size | Receptacle Front View | | Receptacle Side View | | | | | | |
|------------|-----------------------|--------|----------------------|---------------------|----------------|---------|-------------------|------|-------------------|
| | H Hex Max. | S Max. | A Dia. +.001 - .005 | J Flat +.000 - .010 | K +.011 - .010 | M ±.005 | P Panel Thickness | | R Thread Class 2A |
| | | | | | | | Min. | Max. | |
| 8 | .767 | .954 | .473 | .530 | .125 | .696 | .062 | .125 | .5625-24 UNEF |
| 10 | .892 | 1.078 | .590 | .655 | .125 | .696 | .062 | .125 | .6875-24 NEF |
| 12 | 1.079 | 1.266 | .750 | .818 | .125 | .696 | .062 | .125 | .8750-20 UNEF |
| 14 | 1.205 | 1.391 | .875 | .942 | .125 | .696 | .062 | .125 | 1.0000-20 UNEF |
| 16 | 1.329 | 1.516 | 1.000 | 1.066 | .125 | .696 | .062 | .125 | 1.1250-18 NEF |
| 18 | 1.455 | 1.641 | 1.125 | 1.191 | .125 | .696 | .062 | .125 | 1.2500-18 NEF |
| 20 | 1.579 | 1.828 | 1.250 | 1.316 | .156 | .884 | .062 | .250 | 1.3750-18 NEF |
| 22 | 1.705 | 1.954 | 1.375 | 1.441 | .156 | .884 | .062 | .250 | 1.5000-18 NEF |
| 24 | 1.829 | 2.078 | 1.500 | 1.566 | .156 | .917 | .062 | .250 | 1.6250-18 NEF |

| Shell Size | Class "SE", MS / "E" | | Class "SE" (SR), MS / "F" | | | | Class "SP", MS / "P" | | |
|------------|----------------------|--------|---------------------------|-------------|--------|--------|----------------------|--------|-------------|
| | L Max. | N Max. | F Min. | G Dia. Free | L Max. | N Max. | G Dia. | L Max. | N Dia. Max. |
| 8 | 1.438 | .749 | .234 | .125 | 1.922 | .828 | - | - | - |
| 10 | 1.438 | .874 | .297 | .188 | 1.922 | .891 | .444 | 1.656 | .734 |
| 12 | 1.438 | .999 | .422 | .312 | 1.922 | 1.016 | .558 | 1.656 | .858 |
| 14 | 1.438 | 1.124 | .547 | .375 | 1.922 | 1.141 | .683 | 1.656 | .984 |
| 16 | 1.438 | 1.249 | .609 | .500 | 2.000 | 1.203 | .808 | 1.656 | 1.110 |
| 18 | 1.438 | 1.374 | .734 | .625 | 2.000 | 1.469 | .909 | 1.656 | 1.234 |
| 20 | 1.625 | 1.530 | .734 | .625 | 2.172 | 1.469 | 1.034 | 1.922 | 1.360 |
| 22 | 1.625 | 1.655 | .922 | .750 | 2.172 | 1.656 | 1.159 | 1.922 | 1.484 |
| 24 | 1.688 | 1.780 | .984 | .800 | 2.234 | 1.750 | 1.284 | 1.951 | 1.610 |

All dimensions for reference only.

PT08 SE SP08 SE 90 degree plug

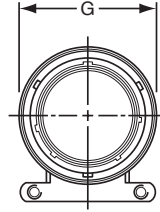

TERMINATION ASSEMBLIES

“SE” Open Wire Seal, “SE” (SR) Strain Relief

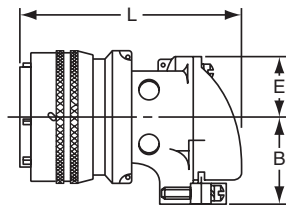

PT08SE-XX-XXX
SP08SE-XX-XXX
PT08SE-XX-XXX (SR)
SP08SE-XX-XXX (SR)

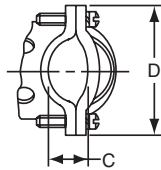

“SP” Potting Boot 75 degrees

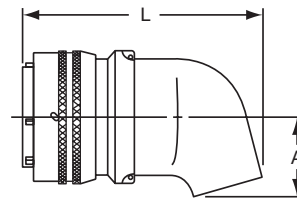

PT08SP-XX-XXX
SP08SP-XX-XXX

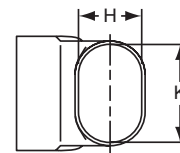

To complete part number see how to order on page 36.
All lockwire holes are .044 Dia. Min.

| Shell Size | Plug Front View | Plug Side View | | | | | | | | |
|------------|-----------------|-----------------------|----------------|---------|----------------|--------|------------|---------|---------|--------|
| | G Dia. Max. | Class “SE”, “SE” (SR) | | | | | Class “SP” | | | |
| | | B ±.031 | C +.010 -0.025 | D ±.062 | E +.047 -0.025 | L Max. | A ±.025 | H ±.015 | K ±.015 | L Max. |
| 10 | .921 | .749 | .170 | 1.191 | .393 | 2.137 | .547 | .438 | .562 | 2.031 |
| 12 | 1.046 | .812 | .264 | 1.191 | .450 | 2.222 | .625 | .516 | .688 | 2.093 |
| 14 | 1.171 | .905 | .310 | 1.254 | .519 | 2.370 | .734 | .625 | .781 | 2.203 |
| 16 | 1.297 | 1.030 | .330 | 1.316 | .583 | 2.572 | .750 | .656 | .890 | 2.250 |
| 18 | 1.422 | 1.015 | .444 | 1.562 | .621 | 2.680 | .781 | .703 | 1.000 | 2.296 |
| 20 | 1.562 | 1.077 | .510 | 1.625 | .683 | 2.753 | .859 | .766 | 1.125 | 2.343 |
| 22 | 1.672 | 1.139 | .515 | 1.719 | .739 | 2.799 | .906 | .812 | 1.234 | 2.390 |
| 24 | 1.797 | 1.250 | .656 | 1.750 | .787 | 3.037 | 1.181 | .918 | 1.374 | 2.624 |

All dimensions for reference only.

PT-SE, SP-SE, MS/PT-SE

how to order

PT-SE, SP-SE

To more easily illustrate ordering procedure, part number PT00SE-20-41PW(SR) is shown as follows:

| | | | | | | | | | |
|----|----|----|---|----|---|----|---|---|------|
| PT | 00 | SE | - | 20 | - | 41 | P | W | (SR) |
| 1 | 2 | 3 | 4 | 5 | 6 | 7 | 8 | | |

See code below:

1. Connector Type

- "PT" designates standard olive drab, electrically conductive cadmium plated, bayonet lock connector with crimp contacts
- "MF" designates standard olive drab, electrically conductive cadmium plated, bayonet lock connector with dual mounting holes, and crimp contacts
- "SP" designates electrically non-conductive, hard anodic coated, bayonet lock connector with larger flange and mounting holes for back panel mounting, and crimp contacts
- "PTG" designates plug with grounding fingers

2. Shell Style

- "00" designates wall mounting receptacle
- "01" designates cable connecting receptacle*
- "02" designates box mounting receptacle
- "06" designates straight plug
- "07" designates jam nut receptacle
- "08" designates 90 degree plug

3. Service Classes

- "SE" designates environmental crimp
- "SP" designates potted type crimp

Both of the above are Amphenol proprietary versions of the MIL-DTL-26482, Series 1 crimp contact connector and offer 15 lbs. contact retention for size 20 contacts; 25 lbs. for size 16 contacts.

- "PG" designates adapter for cable gland for moisture proofing jacketed cables

4. Shell Size

- "20" designates shell size. Shell sizes 8 through 24 available.

5. Insert Arrangement

Refer to pages 4-10 for insert availability.

- "20 - 41" designates insert arrangement. (The number following the hyphen is the number only that is used in the part number).

6. Contacts

- "P" designates pin contacts
- "S" designates socket contacts

7. Insert Rotation

Refer to page 6.

- "W", "X", "Y", "Z" designate that insert is rotated in its shell from "normal" position. No letter required for normal (no rotation) position.

8. "SR" designates a strain relief clamp.

Indicate optional finishes as follows:

- (003) olive drab cadmium plate (standard on "PT")

OR

RoHS Compliant finish suffix as follow:

- (005) anodic coating - Alumilite® (standard on "SP")
- (023) electroless nickel
- (025) black zinc cobalt plating
- (072) conductive gray zinc nickel plating
- (424) electroless nickel finish with strain relief
- (470) black zinc cobalt plating with strain relief



MS/PT-SE

MIL-DTL-26482, Series 1

To more easily illustrate ordering procedure, part number MS3120E20-41PW is shown as follows:

| | | | | | | | | |
|----|-----|---|---|----|---|----|---|---|
| MS | 312 | 0 | E | 20 | - | 41 | P | W |
| 1 | 2 | 3 | 4 | 5 | 6 | 7 | 8 | |

See code below:

1. "MS" designates Military Standard

2. Specification Number

- "312" designates basic family for MIL-DTL-26482, Series 1 crimp type

3. Shell Style

- "0" designates wall mounting receptacle
- "1" designates cable connecting receptacle*
- "2" designates box mounting receptacle
- "4" designates jam nut receptacle
- "6" designates straight plug
- "7" designates box mounting receptacle with dual mounting holes
- "8" designates wall mounting receptacle with dual mounting holes

4. Service Class

- "E" designates environmental resisting connector
- "F" designates environmental resisting connector with strain relief
- "P" designates potted type with potting boot

5. Shell Size

- "20" designates shell size. Shell sizes 8 through 24 available

6. Insert Arrangement

Refer to pages 4-10 for insert availability.

- "20 - 41" designates insert arrangement. (The number following the hyphen is the number only that is used in the part number).

7. Contacts

- "P" designates pin contacts
- "S" designates socket contacts

8. Insert Rotation

Refer to page 6.

- "W", "X", "Y", "Z" designate that insert is rotated in its shell from the "normal" position. No letter required for normal (no rotation) position.

* This connector style is sometimes referred to as a cable connecting "plug". It does, however, mate with either a straight or 90 degree plug.

PT & SP

accessories – sealing plugs, flange gaskets, potting boots

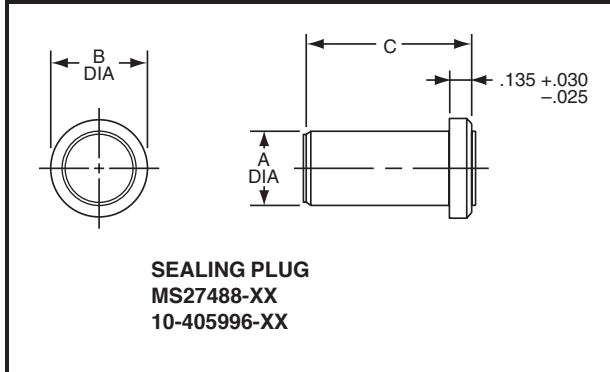

SEALING PLUGS – FOR PT & SP

| Contact Size | Amphenol® Part Number | MS Number | A Dia. ±.010 | B Dia. ±.005 | C ±.010 | Color Code |
|--------------|-----------------------|------------|--------------|--------------|---------|------------|
| 12 | 10-405996-12 | MS27488-12 | .121 | .171 | .564 | Yellow |
| 16 | 10-405996-16 | MS27488-16 | .083 | .133 | .564 | Blue |
| 20 | 10-405996-20 | MS27488-20 | .060 | .090 | .564 | Red |

How to Order: Order by 10- (Proprietary) or MS part number as shown in chart above.

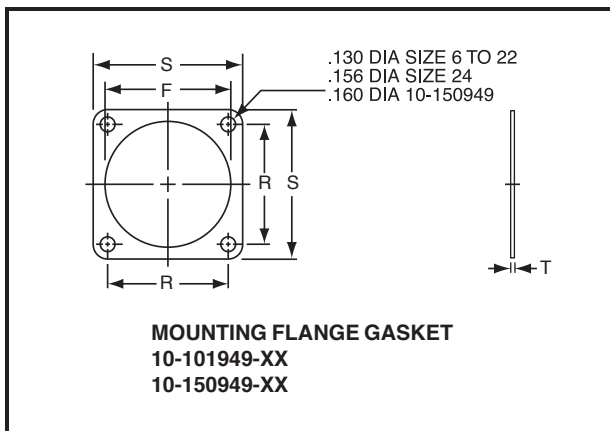

MOUNTING FLANGE GASKETS – FOR PT & SP

| Shell Size | PT 10-101949 | | SP 10-150949 | | PT & SP 10-101949 10-150949 | |
|------------|-----------------|---------|-----------------|---------|-----------------------------------|---------|
| | R ±.010 | S ±.010 | R ±.010 | S ±.010 | F +.016 -.000 | T ±.008 |
| 6 | .469 | .688 | .641 | .953 | .375 | .024 |
| 8 | .594 | .812 | .734 | 1.047 | .500 | .024 |
| 10 | .719 | .938 | .812 | 1.125 | .625 | .024 |
| 12 | .813 | 1.031 | .938 | 1.250 | .750 | .024 |
| 14 | .906 | 1.125 | 1.031 | 1.344 | .875 | .024 |
| 16 | .969 | 1.219 | 1.125 | 1.438 | 1.000 | .024 |
| 18 | 1.063 | 1.312 | 1.203 | 1.516 | 1.125 | .024 |
| 20 | 1.156 | 1.438 | 1.297 | 1.672 | 1.250 | .024 |
| 22 | 1.250 | 1.563 | 1.375 | 1.750 | 1.375 | .024 |
| 24 | 1.375 | 1.688 | 1.500 | 1.875 | 1.500 | .024 |

How to Order: For PT: 10-101949-XX (complete order number with desired shell size).

For SP: 10-150949-XX (complete order number with desired shell size).

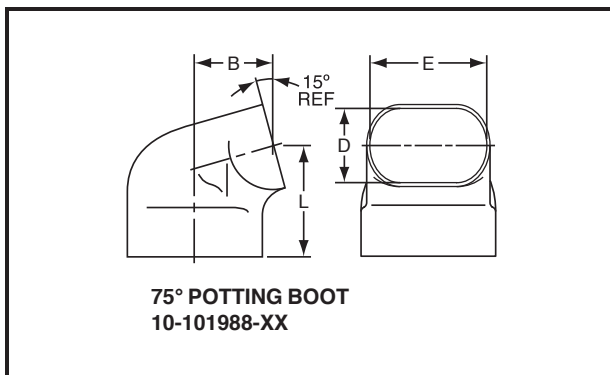

75° POTTING BOOTS – FOR PT & SP

| Shell Size | B Max. | D ±.015 | E ±.015 | L Max. |
|------------|--------|---------|---------|--------|
| 8 | .433 | .312 | .438 | .766 |
| 10 | .493 | .438 | .562 | .830 |
| 12 | .552 | .516 | .688 | .861 |
| 14 | .643 | .625 | .781 | .916 |
| 16 | .658 | .656 | .890 | .936 |
| 18 | .689 | .703 | 1.000 | .959 |
| 20 | .750 | .766 | 1.125 | 1.052 |
| 22 | .794 | .812 | 1.234 | 1.073 |
| 24 | 1.070 | .918 | 1.374 | 1.310 |

How to Order: 10-101988-XX (complete order number with desired shell size).

All dimensions for reference only.

PT & SP

accessories – clamps

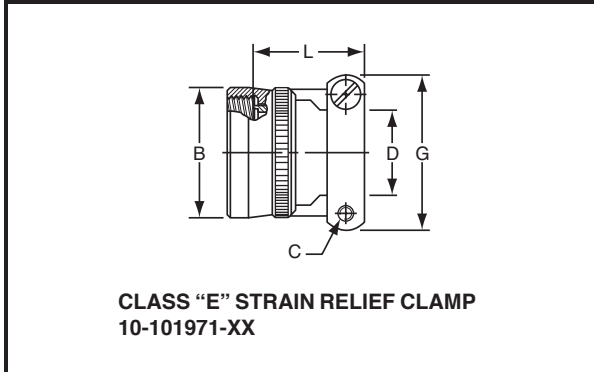

CLASS "E" STRAIN RELIEF CLAMP – FOR PT & SP

| Shell Size | B Max. | C Thread Class 2B | D Min. | G Max. | L Max. |
|------------|--------|-------------------|--------|--------|--------|
| 8 | .550 | 6-32 NC | .240 | .812 | .930 |
| 10 | .675 | 6-32 NC | .302 | .875 | .930 |
| 12 | .803 | 6-32 NC | .428 | 1.000 | .930 |
| 14 | .920 | 6-32 NC | .552 | 1.125 | .930 |
| 16 | 1.047 | 6-32 NC | .615 | 1.188 | 1.062 |
| 18 | 1.165 | 8-32 NC | .740 | 1.438 | 1.062 |
| 20 | 1.291 | 8-32 NC | .740 | 1.438 | 1.093 |
| 22 | 1.418 | 8-32 NC | .928 | 1.719 | 1.093 |
| 24 | 1.533 | 8-32 NC | .928 | 1.719 | 1.093 |

How to Order: 10-101971-XX X
 Add desired shell size Add desired finish suffix†
 "3" designates olive drab cadmium
 "5" designates Alumilite®

Not for use with jam nut style connectors.

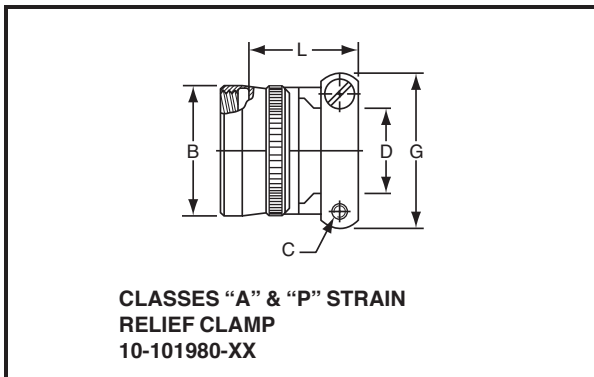

CLASSES "A" & "P" STRAIN RELIEF CLAMP – FOR PT & SP

| Shell Size | B Max. | C Thread Class 2B | D Min. | G Max. | L +.010 - .020 |
|------------|--------|-------------------|--------|--------|----------------|
| 8 | .540 | 6-32 NC | .240 | .812 | .843 |
| 10 | .665 | 6-32 NC | .302 | .875 | .843 |
| 12 | .793 | 6-32 NC | .428 | 1.000 | .843 |
| 14 | .910 | 6-32 NC | .552 | 1.125 | .843 |
| 16 | 1.037 | 6-32 NC | .614 | 1.188 | .975 |
| 18 | 1.155 | 8-32 NC | .740 | 1.438 | .975 |
| 20 | 1.281 | 8-32 NC | .740 | 1.438 | 1.007 |
| 22 | 1.408 | 8-32 NC | .928 | 1.719 | 1.007 |
| 24 | 1.533 | 8-32 NC | .938 | 1.719 | 1.007 |

How to Order: 10-101980-XX X
 Add desired shell size Add desired finish suffix†
 "3" designates olive drab cadmium
 "5" designates Alumilite®

Not for use with jam nut style connectors.

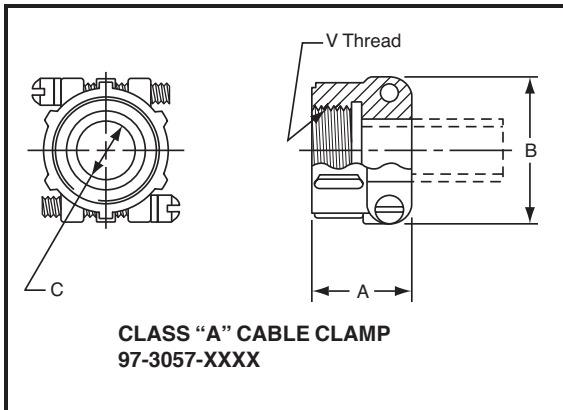

CLASS "A" CABLE CLAMPS – FOR PT & SP

| Shell Size | Amphenol® Part Number | A ±.031 | B Max. | C Dia. Min. | V Thread |
|------------|-----------------------|---------|--------|-------------|-----------|
| 10 | 97-3057-1004 | .795 | .842 | .3125 | .6250-24 |
| 12 | 97-3057-1007 | .850 | .995 | .4375 | .7500-20 |
| 14 | 97-3057-1008 | .920 | 1.120 | .5625 | .8750-20 |
| 16 | 97-3057-1010 | .920 | 1.216 | .6250 | 1.0000-20 |
| 18/20 | 97-3057-1012 | .927 | 1.403 | .7500 | 1.1875-18 |
| 22/24 | 97-3057-1016 | 1.015 | 1.683 | .9375 | 1.4375-18 |

How to Order: Order by 97-3057-XXXX number listed above. Standard finish is olive drab zinc alloy. Consult Amphenol, Sidney, NY for alternate finishes.

† Standard accessory finishes are "3" olive drab cadmium for PT and MS/PT types, "5" Alumilite® for SP types. Electroless nickel plating is also available on some items; consult Amphenol, Sidney, NY

All dimensions for reference only.

PT, SP, MS/PT accessories – protection caps

RECEPTACLE PROTECTION CAP FOR PT, SP, MS/PT CONNECTORS

10-101960-XXX
MS3181-XXX
(Wall Receptacle)

10-101961-XXX
(Cable Connecting Receptacle)

10-101964-XXX
MS3181-XXX
(Jam Nut Receptacle)

RECEPTACLE PROTECTION CAPS – FOR PT, SP, MS/PT

| Shell Size | B Dia. +.010 -.000 | C Dia. +.010 -.000 | G Dia. Max. | L +.020 -.000 | X Std. & MS RA, CA, NA | X MS only RAL/CAL/NAL |
|------------|-----------------------|-----------------------|-------------|------------------|---------------------------|--------------------------|
| 6 | .328 | .454 | .577 | .563 | 3.000 | 5.000 |
| 8 | .454 | .578 | .706 | .563 | 3.000 | 5.000 |
| 10 | .578 | .703 | .816 | .563 | 3.000 | 5.000 |
| 12 | .703 | .891 | 1.000 | .563 | 3.500 | 5.000 |
| 14 | .844 | 1.016 | 1.128 | .563 | 3.500 | 5.000 |
| 16 | .969 | 1.141 | 1.257 | .563 | 3.500 | 5.000 |
| 18 | 1.094 | 1.266 | 1.367 | .563 | 3.500 | 5.000 |
| 20 | 1.219 | 1.391 | 1.496 | .563 | 4.000 | 5.000 |
| 22 | 1.343 | 1.516 | 1.624 | .563 | 4.000 | 5.000 |
| 24 | 1.453 | 1.614 | 1.747 | .603 | 4.000 | 5.000 |

How to Order Proprietary Receptacle Caps:

Wall Receptacle Caps: 10-101960- XX X

Cable Connecting Receptacle Caps: 10-101961- XX X

Jam Nut Receptacle Caps: 10-101964- XX X

Add desired shell size _____

Add desired finish suffix† _____

“FL” designates gray zinc nickel

“3” designates olive drab cadmium

“5” designates Alumilite®

Proprietary caps are supplied with standard bead chains only (as shown in drawing at left). For other chain options, an MS version cap should be ordered.

How to Order MS Version Receptacle Caps:

Wall Receptacle Caps: MS3181- XX -CA for sash chain
-CAL for long sash chain
-RA for rope chain

Jam Nut Recept. Caps: MS3181- XX -NA for sash chain
-NAL for long sash chain

Shell size _____

MS versions are supplied with standard anodize finish only. For other finish options a proprietary cap should be ordered.

PLUG PROTECTION CAP FOR PT, SP, MS/PT CONNECTORS

MS3180-XXX

10-101957-XXX

PLUG PROTECTION CAPS – FOR PT, SP, MS/PT

| Shell Size | N Dia. +.001 -.005 | L Dia. +.025 -.015 | X Std. & MS CA, RA | X MS only CAL/RAL |
|------------|-----------------------|-----------------------|-----------------------|----------------------|
| 6 | .348 | .532 | 3.000 | 5.000 |
| 8 | .473 | .532 | 3.000 | 5.000 |
| 10 | .590 | .532 | 3.000 | 5.000 |
| 12 | .750 | .532 | 3.500 | 5.000 |
| 14 | .875 | .532 | 3.500 | 5.000 |
| 16 | 1.000 | .532 | 3.500 | 5.000 |
| 18 | 1.125 | .532 | 3.500 | 5.000 |
| 20 | 1.250 | .594 | 4.000 | 5.000 |
| 22 | 1.375 | .594 | 4.000 | 5.000 |
| 24 | 1.500 | .627 | 4.000 | 5.000 |

How to Order Proprietary Plug Caps: 10-101957-XX X

Add desired shell size _____

Add desired finish suffix† _____

“FL” designates gray zinc nickel

“3” designates olive drab cadmium

“5” designates Alumilite®

Proprietary caps are supplied with standard bead chains only (as shown in drawing at left). For other chain options an MS version cap should be ordered.

How to Order MS Version Plug Caps: MS3180- XX -CA for sash chain

-CAL for long sash chain

-RA for rope chain

-RAL for long rope chain

† Standard accessory finishes are “3” olive drab cadmium for PT and MS/PT types, “5” Alumilite® for SP types. Electroless nickel plating is also available on some items; consult Amphenol, Sidney, NY

All dimensions for reference only.

PT & SP

accessories – dummy receptacles, “O” rings, plastic dust caps

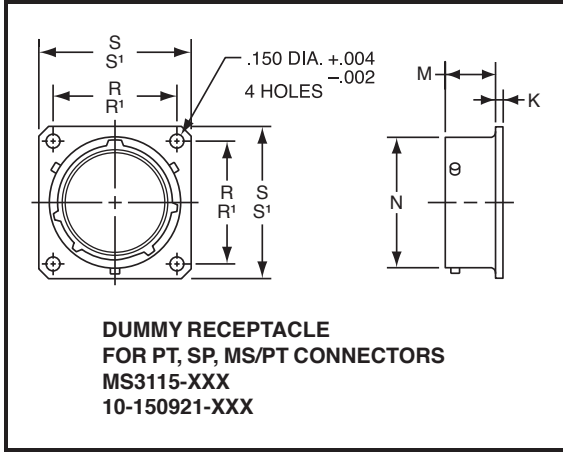

DUMMY RECEPTACLES – FOR PT, SP, MS/PT

| Shell Size | K ±.010 | M +.030 -.000 | N +.001 -.005 | Proprietary Version | | MS Version | |
|------------|------------|---------------------|---------------------|---------------------|------------|------------|------------|
| | | | | R ±.005 | S ±.010 | R' (TP) | S' (TP) |
| 8 | .062 | .462 | .473 | .734 | 1.047 | .594 | .828 |
| 10 | .062 | .462 | .590 | .812 | 1.125 | .719 | .954 |
| 12 | .062 | .462 | .750 | .938 | 1.250 | .812 | 1.047 |
| 14 | .062 | .462 | .875 | 1.031 | 1.344 | .906 | 1.141 |
| 16 | .062 | .462 | 1.000 | 1.125 | 1.438 | .969 | 1.234 |
| 18 | .062 | .462 | 1.125 | 1.203 | 1.516 | 1.062 | 1.328 |
| 20 | .062 | .556 | 1.250 | 1.297 | 1.672 | 1.156 | 1.453 |
| 22 | .062 | .556 | 1.375 | 1.375 | 1.750 | 1.250 | 1.578 |
| 24 | .062 | .589 | 1.500 | 1.500 | 1.875 | 1.375 | 1.703 |

How to Order Proprietary Dummy Receptacles: 10-150921-XX X

Add desired shell size _____
 Add desired finish suffix† _____
 † "FL" designates gray zinc nickel
 † "3" designates olive drab cadmium
 † "5" designates Alumilite®

How to Order MS Version Dummy Receptacles: MS3115-XX X

Add desired shell size _____
 Add desired finish suffix† _____
 † -A designates Alumilite®
 † -L designates electroless nickel
 † -W designates olive drab cadmium

PLASTIC DUST CAPS

FOR PT, SP

| Shell Size | Plug Plastic Dust Cap | Receptacle Plastic Dust Cap |
|------------|-----------------------|-----------------------------|
| 6 | 10-70500-8 | 10-70506-8S |
| 8 | 10-70506-12 | 10-70506-10 |
| 10 | 10-70500-12 | 10-70506-12 |
| 12 | 10-70506-16 | 10-70506-14 |
| 14 | 10-70506-18 | 10-70506-16 |
| 16 | 10-70506-20 | 10-70506-18 |
| 18 | 10-70506-22 | 10-70506-20 |
| 20 | 10-70506-24 | 10-79506-22 |
| 22 | 10-70524-1 | 10-70506-24 |
| 24 | 10-70506-28 | 10-70524-1 |

How to Order Plastic Dust Caps:

To the basic order number add the dust cap size to match connector plug or receptacle shell size, as shown in the tables above.
 Example: 10-70506-12 would be the correct order number for a plastic dust cap for a PT00 receptacle, shell size 10.

All dimensions for reference only.

PT accessories glands

Nylon Cable Glands

Material: Nylon 66 (UL Approved 94V-2)
 Seal Ring: UL 94V-2(UL Approved 94V-2)
 Thread Type: Metric , PG, NPT
 Temp Range: Static: - 40°C ~ +100°C
 Dynamic: - 20°C ~ + 80°C
 Short Term: +120°C
 Current Colors: Gray, Black

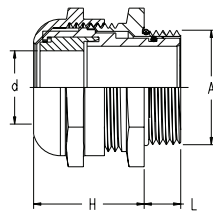

Metal Cable Glands

Material: Brass with Nickel; Brass with Tin/Nickel
 Clamping: UL approved PA6, 94V-0
 Seal Ring: UL 94V-2 (UL approved NBR, 94V-2;UL approved DOW CORNING RUBBER, 94V-0)
 Thread Type: Metric, PG, NPT
 Protective: IP68 (tighten with o-ring)
 Temp Range: - 40°C ~ +100°C
 Torque Value (N-M) of hex and cap nuts: 3.0-4.5 N-M
 M12, M16, M20 are UL recognized under file # E339605

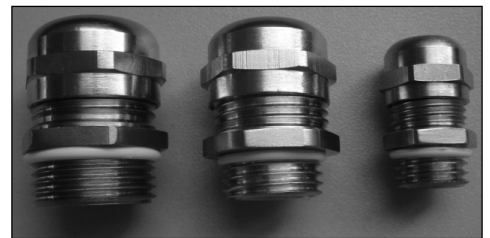
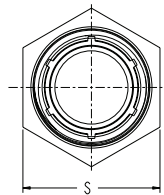

Nylon Cable Glands

| AIGO Part | Thread "A" | Max "d" (mm) | Cable Range (mm) | Thread "L" (mm) | Clamp "H" (mm) | Spanner "S" (mm) |
|--------------|------------|--------------|------------------|-----------------|----------------|------------------|
| AIO-CSM12 | M12x1.5 | 8 | 3-6.5 | 8 | 20 | 15 |
| AIO-CSM16 | M16x1.5 | 8 | 4-8 | 8 | 22 | 19 |
| AIO-CSM18 | M18x1.5 | 10 | 5-10 | 9 | 25 | 22 |
| AIO-CSM20 | M20x1.5 | 12 | 6-12 | 9 | 30 | 24 |
| AIO-CSM22 | M22x1.5 | 14 | 10-14 | 10 | 30 | 27 |
| AIO-CSM24 | M24x1.5 | 14 | 10-14 | 10 | 30 | 27 |
| AIO-CSM25 | M25x1.5 | 18 | 13-18 | 10 | 30 | 33 |
| AIO-CSM30 | M30x2.0 | 18 | 13-18 | 11 | 33 | 33 |
| AIO-CSM32 | M32x1.5 | 25 | 18-25 | 11 | 38 | 42 |
| AIO-CSM33 | M33x2.0 | 25 | 18-25 | 11 | 39 | 42 |
| AIO-CSM40 | M40x1.5 | 32 | 22-32 | 13 | 48 | 54 |
| AIO-CSM50 | M50x1.5 | 38 | 32-38 | 14 | 50 | 60 |
| AIO-CSM72 | M72x2.0 | 57 | 51-57 | 16 | 75 | 80 |
| AIO-CSIN1/2 | NPT1/2" | 12 | 6-12 | 13.6 | 28 | 24 |
| AIO-CSIN3/4 | NPT3/4" | 18 | 13-18 | 14.1 | 32 | 33 |
| AIO-CSIN5/4 | NPT1"1/4" | 32 | 22-32 | 17.3 | 46 | 54 |
| AIO-CSIN3/2 | NPT1"1/2" | 32 | 22-32 | 17.3 | 50 | 54 |
| AIO-CSGIN1/2 | G1/2" | 12 | 6-12 | 9 | 26 | 24 |
| AIO-CSGIN3/4 | G3/4" | 18 | 13-18 | 11 | 27 | 33 |
| AIO-CSGIN1 | G1" | 25 | 18-25 | 11 | 33 | 42 |
| AIO-CSGIN5/4 | G1"1/4" | 28 | 21-28 | 13 | 48 | 54 |
| AIO-CSGIN3/2 | G1"1/2" | 32 | 22-32 | 13 | 48 | 54 |
| AIO-CSGIN5/2 | G2"1/2" | 57 | 51-57 | 14 | 75 | 80 |
| AIO-CSPG7 | PG7 | 6.5 | 3-6.5 | 8 | 20 | 15 |
| AIO-CSPG9 | PG9 | 8 | 4-8 | 8 | 22 | 19 |
| AIO-CSPG11 | PG11 | 10 | 5-10 | 8 | 24 | 22 |
| AIO-CSPG13.5 | PG13.5 | 12 | 6-12 | 9 | 26 | 24 |
| AIO-CSPG16 | PG16 | 14 | 10-14 | 10 | 28 | 27 |
| AIO-CSPG21 | PG21 | 18 | 13-18 | 11 | 33 | 33 |
| AIO-CSPG29 | PG29 | 25 | 18-25 | 11 | 38 | 42 |
| AIO-CSPG36 | PG36 | 32 | 22-32 | 13 | 48 | 54 |
| AIO-CSPG42 | PG42 | 38 | 32-38 | 14 | 52 | 60 |

For additional information on other products available refer to our Cord Grips & Cable Glands, Catalog 12-055.

Metal Cable Glands

| AIGO Part | Thread "A" | Max "d" (mm) | Cable Range (mm) | Thread "L" (mm) | Clamp "H" (mm) | Spanner "S" (mm) |
|---------------|------------|--------------|------------------|-----------------|----------------|------------------|
| AIO-CSJM12 | M12x1.5 | 6.5 | 3-6.5 | 6.2 | 15 | 14 |
| AIO-CSJM14 | M14x1.5 | 8 | 4-8 | 5 | 19 | 15 |
| AIO-CSJM16 | M16x1.5 | 9 | 6-9 | 6.3 | 20 | 18 |
| AIO-CSJM18 | M18x1.5 | 10 | 5-10 | 7 | 20 | 22 |
| AIO-CSJM20 | M20x1.5 | 12 | 6-12 | 8.3 | 20 | 22 |
| AIO-CSJM22 | M22x1.5 | 14 | 10-14 | 8 | 24 | 24 |
| AIO-CSJM24 | M24x1.5 | 14 | 10-14 | 8 | 24 | 27 |
| AIO-CSJM25 | M25x1.5 | 18 | 13-18 | 7.8 | 23 | 30 |
| AIO-CSJM27 | M27x2.0 | 18 | 13-18 | 8 | 26 | 30 |
| AIO-CSJM30 | M30x2.0 | 18 | 13-18 | 8 | 26 | 32 |
| AIO-CSJM32 | M32x1.5 | 25 | 18-25 | 10 | 27 | 40 |
| AIO-CSJM36 | M36x2.0 | 25 | 18-25 | 10 | 34 | 40 |
| AIO-CSJM40 | M40x1.5 | 32 | 22-32 | 10 | 39 | 50 |
| AIO-CSJM50 | M50x1.5 | 38 | 32-38 | 11 | 39 | 60 |
| AIO-CSJM63 | M63x1.5 | 44 | 37-44 | 12 | 43 | 67 |
| AIO-CSJM72 | M72x2.0 | 52 | 46-52 | 16 | 47 | 75 |
| AIO-CSJM80 | M80x2.0 | 60 | 52-60 | 20 | 57 | 90 |
| AIO-CSJM90 | M90x2.0 | 70 | 62-70 | 20 | 57 | 100 |
| AIO-CSJIN1/2 | NPT1/2" | 12 | 6-12 | 13.6 | 25 | 24 |
| AIO-CSJIN3/4 | NPT3/4" | 18 | 13-18 | 14.1 | 26 | 30 |
| AIO-CSJIN5/4 | NPT1"1/4" | 32 | 22-32 | 17.3 | 41 | 50 |
| AIO-CSJIN3/2 | NPT1"1/2" | 32 | 22-32 | 17.3 | 46 | 50 |
| AIO-CSJIN2 | NPT2" | 44 | 37-44 | 17.7 | 46 | 65 |
| AIO-CSJIN5/2 | NPT2 1/2" | 52 | 46-52 | 23.7 | 58 | 80 |
| AIO-CSJIN3 | NPT3" | 70 | 62-70 | 26 | 58 | 100 |
| AIO-CSJGIN1/2 | G1/2" | 12 | 6-12 | 8 | 24 | 24 |
| AIO-CSJGIN3/4 | G3/4" | 18 | 13-18 | 8 | 27 | 30 |
| AIO-CSJGIN1 | G1" | 25 | 18-25 | 10 | 34 | 40 |
| AIO-CSJGIN5/4 | G1"1/4" | 32 | 22-32 | 10 | 39 | 50 |
| AIO-CSJGIN3/2 | G1"1/2" | 32 | 22-32 | 10 | 39 | 50 |
| AIO-CSJGIN2 | G2" | 44 | 37-44 | 12 | 44 | 65 |
| AIO-CSJGIN5/2 | G2 1/2" | 52 | 46-52 | 16 | 47 | 82 |
| AIO-CSJGIN3 | G3" | 70 | 62-70 | 20 | 55 | 100 |
| AIO-CSJPG7 | PG7 | 6.5 | 3-6.5 | 6 | 18 | 14 |
| AIO-CSJPG9 | PG9 | 8 | 4-8 | 7 | 21 | 18 |
| AIO-CSJPG11 | PG11 | 10 | 5-10 | 7 | 20 | 22 |
| AIO-CSJPGM16 | M16x1.5 | 10 | 6.2-10 | 6.5 | 22 | 20 |
| AIO-CSJPG13.5 | PG13.5 | 12 | 6-12 | 8 | 24 | 22 |
| AIO-CSJPG16 | PG16 | 14 | 10-14 | 8 | 25 | 24 |
| AIO-CSJPG21 | PG21 | 18 | 13-18 | 8 | 26 | 30 |
| AIO-CSJPG36 | PG36 | 32 | 22-32 | 10 | 38 | 50 |
| AIO-CSJPG42 | PG42 | 38 | 32-38 | 11 | 42 | 60 |
| AIO-CSJPG48 | PG48 | 44 | 37-44 | 12 | 44 | 65 |

Application Tools

“SE”

The following data includes information pertaining to the application tools for crimping, inserting and removing size 20, 16, and 12 contacts incorporated in Amphenol® Miniature Cylindrical Connectors.

All crimping tools included are the “full cycling” type, and when used as specified by the manufacturer, provide reliable crimped wire to contact termination.

Tool frames and turret heads are available from approved tool manufacturers; consult Amphenol, Sidney, NY for listings.

Assembly instructions are available online at www.amphenol-industrial.com

See the following:

L-786 for SE assembly instructions

L-555 for solder type instructions

CRIMPING TOOLS

FOR PT-SE, SP-SE, MS/PT-SE
(MIL-DTL-26482, Series 1) Connectors

| Contact Size | MS Tool Part Number | |
|--------------|---------------------|-------------|
| | Tool Frame | Turret Head |
| 20 | M22520/1-01 | M22520/1-02 |
| 16 | M22520/1-01 | M22520/1-02 |
| 12 | M22520/1-01 | M22520/1-02 |

INSERTION/REMOVAL TOOLS

FOR PT-SE, SP-SE, MS/PT-SE
(MIL-DTL-26482, Series 1) Connectors

| Contact Size | Insertion Tool | | | Removal Tool | |
|--------------|------------------------------------|----------------------------------|---------------------------------------|--------------------------------|-------------------------------------|
| | Amphenol® Contact Insertion Pliers | Amphenol® Contact Insertion Tool | MS Part Number Contact Insertion Tool | Amphenol® Contact Removal Tool | MS Part Number Contact Removal Tool |
| 20 | 11-8107-20 | 11-7401-20 | M81969/17-03 | 11-7880-20 | M81969/19-07 |
| 16 | 11-8107-16 | 11-7401-16 | M81969/17-04 | 11-7880-16 | M81969/19-08 |
| 12 | – | – | M81969/17-05 | – | M81969/19-09 |

Contacts - Power and Thermocouple Crimp for miniature cylindrical connectors

The following tables provide part number information for crimp contacts used in Amphenol® Miniature Cylindrical Connectors. For additional information, consult Amphenol, Sidney, NY.

CRIMP CONTACTS for MIL-DTL-26482, Series 1 (PT-SE, SP-SE) Connectors

| Contact Size | Accommodates Wire Size | Pins | | Sockets | |
|--------------|------------------------|---------------|------------------------------|---------------|------------------------------|
| | | MS Number | Amphenol® Proprietary Number | MS Number | Amphenol® Proprietary Number |
| 20 | 20, 22 & 24 AWG | M39029/31-240 | 10-683787-20P | M39029/32-259 | 10-731210-3D1 |
| 16 | 16, 18 & 20 AWG | M39029/31-228 | 10-683788-16P | M39029/32-247 | 10-679379-16D |
| 12 | 12 & 14 AWG | M39029/31-235 | 10-807100-125 | M39029/32-254 | 10-807103-125 |
| 20-16 | 16 AWG | | 10-330930-20F | | 10-807155-205 |
| 16-20 | 20 AWG | | 10-330932-16F | | 10-330933-16F |
| 12-10 | 12 AWG | | 10-330938-12F | | 10-330939-12F |

THERMOCOUPLE CONTACTS for Miniature Connectors

| Size | Material | Pins Proprietary Part Number | Sockets Proprietary Part Number |
|----------------------|------------|------------------------------|---------------------------------|
| | | SE | SE |
| 16 Crimp Termination | Chromel | 10-330940-21P | 10-330940-21S |
| | Alumel | 10-330940-22P | 10-330940-22S |
| 20 Crimp Termination | Chromel | 10-330940-1P | 10-330940-1S |
| | Alumel | 10-330940-2P | 10-330940-2S |
| | Iron | 10-330940-3P | 10-330940-3S |
| | Constantan | 10-330940-4P | 10-330940-4S |

See L-776 for thermocouple contact termination instructions. These are online at www.amphenol-industrial.com

For PCB contacts for miniature connectors, see page 20.

Coaxial Contacts

for miniature cylindrical connectors

Amphenol® Miniature Connectors can incorporate shielded coax contacts. The Miniature family is built around MIL-DTL-26482 specifications, with Mil-approved and proprietary styles offered. Normal operating voltage for Miniature cylindricals with power only contacts is up to 1,000 VAC (RMS) at sea level.

Table 1: Miniature Cylindricals offer these features for contact termination flexibility:

- Several insert arrangements that can incorporate:
 - Size 8 & 12 Crimp Coax contacts for Crimp type
 - Size 8 & 12 Solder Coax contacts for Solder type
- Wide selection of connector shell styles and sizes
- Standard power contact options within the various connector styles include: solder type, crimp front release, crimp rear release
- Coax contacts are designed to the same high performance standards as power contacts. Coax and power contacts may be intermixed with no degradation of connector reliability.
- No mis-mating or cross-plugging with insert rotation and keyway polarization.

Table 2: GENERAL ORDERING INFORMATION

Amphenol Miniature Cylindricals are normally supplied with a full complement of power contacts, separately packaged. Coax contacts are ordered by part number as referenced in the part number charts on the following pages of this catalog, and are substituted for the power contacts at the time of the cable or equipment assembly. If the application is for coax only, the connector may be ordered less contacts and no power contacts will be supplied.

Installation instructions for the coax contacts for Miniature Connectors are provided in Amphenol documents as follows: L-633 for solder type; L-613 for SE type.

HOW TO ORDER:

- A. Select the coax contacts designed for the cable being used from the applicable charts in this catalog for each Miniature type (solder, SE).
- B. Select a connector insert from those shown on pages 4-5 which will accommodate the quantity and size of coaxial contacts needed plus any power contacts required. Note: Size 8S and 12S contacts are used with connector inserts through shell size 18 only. For larger connector shell sizes, use size 8L contacts.
- C. Determine the Miniature Cylindrical type, shell style, finish, service class and insert rotation required for your application.
- D. Consult Amphenol, Sidney NY with the pertinent cable, contact, insert arrangement and connector style choices for complete connector part number.

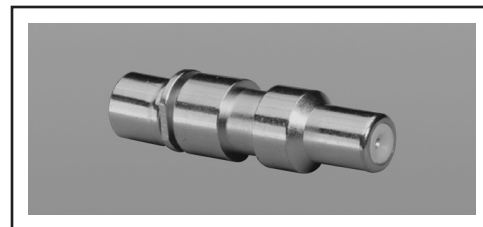

Solder Coax Contact
for use in Miniature Solder Type Connectors

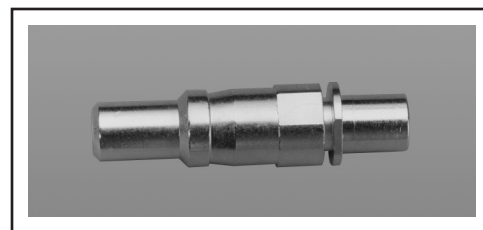

Pin Crimp Coax Contact
for use in Miniature Crimp SE Type Connectors

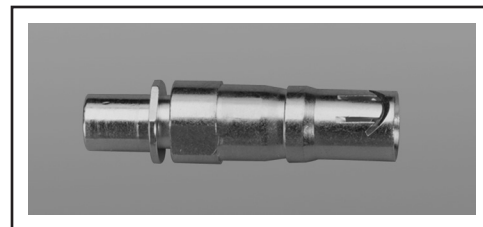

Socket Crimp Coax Contact
for use in Miniature Crimp SE Type Connectors

Coaxial Contacts

for miniature cylindrical connectors, cont.

Amphenol® Coaxial Contacts designed for use in Miniature Cylindrical Connectors offer the same durability advantages and design benefits for reliable interconnection as the Amphenol coax contacts used in high performance D38999 connectors. A variety of military and commercial shielded cables are accommodated within the miniature cylindrical series. Amphenol supplies coax contacts for solder and crimp SE connector styles.

Other features of the coax for miniature cylindricals include:

- Miniature coax design has an outside nut within the assembly for fast, reliable assembly of contact to cable.
- All types feature solder style inner contacts and crimp style outer contacts for reliable cable termination
- Miniature coax crimp type contacts are designed for use in Miniature crimp series connectors
- Miniature coax solder type contacts are designed for use in Miniature solder series connectors. These come pre-installed into the solder connector.

TYPICAL MINIATURE CRIMP COAX SOCKET CONTACT has crimp socket outer contact with a solder pin inner contact

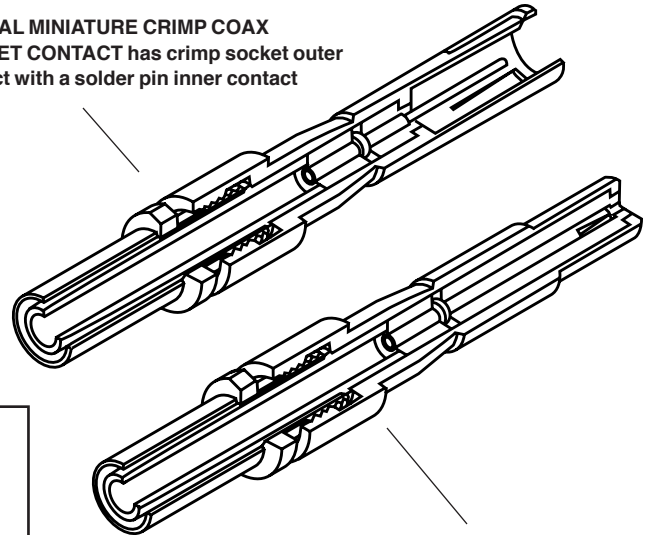

TYPICAL MINIATURE CRIMP COAX PIN CONTACT has crimp pin outer contact with a solder socket inner contact

TYPICAL ELECTRICAL PERFORMANCE

Size 8 and 12 Coax Contacts

Contact Resistance:

Center @ 1 Amp, 170 millivolts max. voltage drop @ 25°C
Outer @ 12 Amps, 150 millivolts max. voltage drop @ 25°C

Dielectric Withstanding Voltage:

Size 8: 1,300 VAC Rms @ sea level
Size 12: 1,000 VAC Rms @ sea level
Size 8 & 12: 250 VAC Rms @ 50,000 ft.

Insulation Resistance

5,000 megohms minimum @ 25°C

Typical VSWR for size 8 & 12 PT-SE Types II & III only:

1.2 + .12F (GHz) up to 10 GHz

EXPLANATION OF TYPE CLASSIFICATIONS:

PT-SE Type I is moisture seal design with internal O-ring.

PT-SE Type II is 50 ohm impedance matched version. Contacts terminated to other than 50 ohm cables are therefore not matched.

PT-SE Type III is 50 ohm contact, non-serviceable after assembly.

Solders are non-impedance matched contacts.

CONTACT FINISHES:

| Suffix | Finish |
|--------|--|
| 1 | 0.00020 min. silver over copper flash |
| 2 | 0.00005 min. gold (Knoop hardness 130-200) over silver |
| 3 | 0.00010 min. gold (Knoop hardness 130-200) over silver |
| 4 | 0.00010 min. gold (Knoop hardness 130-200) over copper |
| 5 | 0.00005 min. gold (Knoop hardness 130-200) over nickel |
| E | 0.00005 min. gold (Knoop hardness 90 max.) over copper |
| F | 0.00005 min. gold (Knoop hardness 130-200) over copper |
| H | 0.00010 min. gold (Knoop hardness 130-200) over copper |

Coaxial Contacts

for miniature cylindrical connectors, cont.
solder (MIL-DTL-26482 Series 1 type) - application data

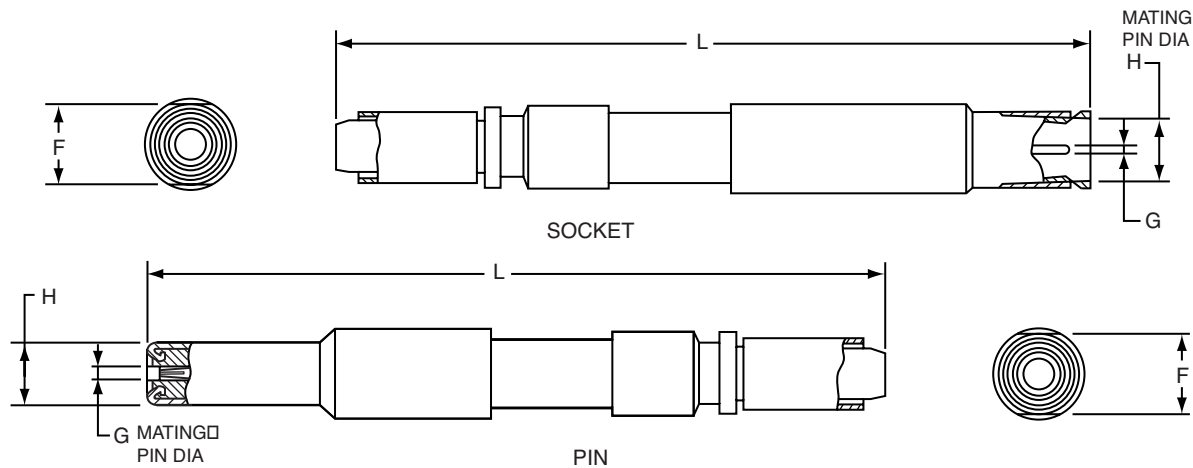

NOTE: All contacts of the same size and the same inner and outer contact diameters (G & H) will mate with each other.

| SOLDER COAX CONTACTS | | | | | | | | | | | | |
|---|---------------------|---------------|--------------|---------------------------------------|---------------|-----------------------|---------------|--------|---|---|---|---------------------|
| For use in Miniature Solder Type Connectors: PT, SP, and MS/PT Styles | | | | | | | | | | | | |
| Cable | Contact Part Number | | Contact Size | Dimensional Data (See Drawings above) | | | | | Crimp Ferrule Tools | | | Retainer Nut Wrench |
| | Pin | Socket | | G Dia. | H Dia. ±0.001 | F Across Flats ±0.004 | L Length Ref. | | MIL-T-22910/7-1 Tool Use with Die Part Number | MIL-C-22520/5-01 Tool Use with Die Part Number | MIL-C-22520/10-01 Tool Use with Die Part Number | |
| | | | | | | | Pin | Socket | | | | |
| RG-58C/U, RG-141A/U, RG-303/U | 21-33020-2 | 21-33019-2 | 8S | 0.040 ± 0.001 | 0.219 | 0.280 | 1.114 | 1.115 | M22910/7-15 (B) | M22520/5-05 (B) M22520/5-41 (B) | M22520/10-07 (B) | 11-8676-2 |
| RG-59B/U, RG-62A/U, RG-62B/U, RG-210/U | 21-33020-1 | 21-33019-1 | 8L | 0.040 ± 0.001 | 0.219 | 0.280 | 1.176 | 1.177 | M22910/7-18 (B) | M22520/5-45 (B) | | 11-8676-3 |
| | 21-33020-3 | 21-33019-3 | 8S | 0.040 ± 0.001 | 0.219 | 0.280 | 1.114 | 1.115 | | | | |
| RG-142B/U, Times MI51115 | 21-33020-7* | 21-33019-7* | 8S | 0.040 ± 0.001 | 0.219 | 0.280 | 1.114 | 1.115 | M22910/7-16 (B) | M22520/5-43 (B) | | 11-8676-2 |
| RG-161/U, RG-174A/U, RG-179B/U, RG-187A/U, RG-188A/U, RG-316/U | 21-33020-32* | 21-33019-32* | 12S | 0.0300 ± 0.0005 | 0.140 | 0.172 | 1.092 | 1.093 | M22910/7-12 (B) | M22520/5-03 (A) M22520/5-08 (A) M22520/5-35 (B) | M22520/10-05 (A) | 11-8676-1 |
| RG-178B/U | 21-33020-4 | 21-33019-4* | 8S | 0.040 ± 0.001 | 0.219 | 0.280 | 1.114 | 1.115 | M22910/7-11 (B) | M22520/5-03 (B) M22520/5-33 (B) | M22520/10-05 (B) | 11-8676-2 |
| RG-196A/U | 21-33020-31† | 21-33061-31†† | 12S | 0.0300 ± 0.0005 | 0.140 | 0.172 | 1.092 | 1.093 | M22910/7-11 (B) | M22520/5-03 (B) M22520/5-33 (B) | M22520/10-05 (B) | 11-8676-1 |
| RG-180B/U, RG-195A/U, Raychem 5022D1312-9 | 21-33020-5* | 21-33019-5* | 8S | 0.040 ± 0.001 | 0.219 | 0.280 | 1.114 | 1.115 | M22910/7-15 (B) | M22520/5-05 (B) M22520/5-41 (B) | M22520/10-07 (B) | 11-8676-2 |
| Raychem 5021D1331-9 | 21-33020-6* | 21-33019-6* | 8S | 0.040 ± 0.001 | 0.219 | 0.280 | 1.114 | 1.115 | M22910/7-15 (B) | M22520/5-05 (B) M22520/5-41 (B) | M22520/10-07 (B) | 11-8676-2 |
| Thermatics 2929-29 | 21-33020-33 | 21-33061-33 | 12S | 0.0200 ± 0.0005 | 0.140 | 0.172 | 1.092 | 1.093 | M22910/7-13 (B) | M22520/5-37 (B) | | 11-8676-1 |

NOTE: Contacts can be ordered by part numbers given in chart

NOTE: Size 8S and 12S contacts are used with connector inserts through shell size 18 only. For larger connector shell sizes, use size 8L contacts.

CONTACT FINISH: For all contacts in this series feature 0.000050 minimum gold (Knoop hardness 130-200).

* Consult Amphenol, Sidney NY for availability

CRIMPING TOOLS: Italicized letters in parenthesis that follow positioner part numbers indicate applicable die closure. Commercial equivalents with the same die closure dimension may be used.

† 21-33020-31 and 21-33061-31 only mate with each other

Coaxial Contacts

for miniature cylindrical connectors, cont.
crimp SE (MIL-DTL-26482 Series 1 type) - application data

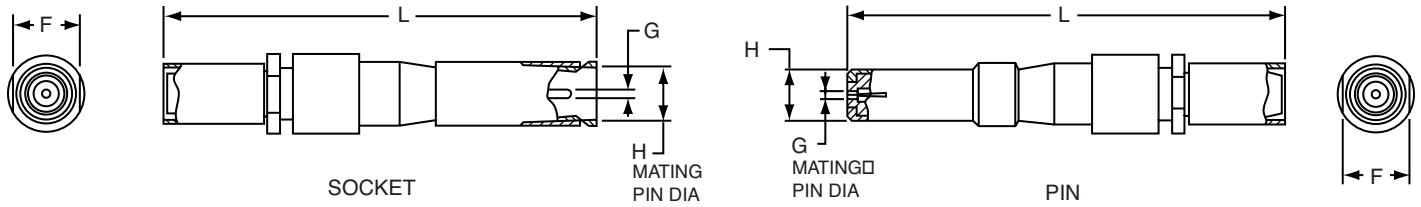

NOTE: All contacts of the same size and the same inner and outer contact diameters (G & H) will mate with each other.

| SE CRIMP COAX CONTACTS | | | | | | | | | | | | | | | | |
|---|----------------------------------|----------------------------------|--------------|---------|------------------------|---------------------------------------|---------------|-----------------------|---------------|---------------------|---|---|---------------------|--|------------|-----------|
| For use in Miniature Crimp Type Connectors: PT-SE, SP-SE, and MS/PT-SE Styles | | | | | | | | | | | | | | | | |
| Cable | Contact Part Number | | Contact Size | Type | Finish on Mating Parts | Dimensional Data (See Drawings above) | | | | Crimp Ferrule Tools | | | Retainer Nut Wrench | Installation Tools | | |
| | | | | | | G Dia. | H Dia. ±0.001 | F Across Flats ±0.004 | L Length Ref. | | MIL-T-22910/7-1 Tool Use with Die Part Number | MIL-C-22520/5-01 Tool Use with Die Part Number | | MIL-C-22520/10-0 Tool Use with Die Part Number | Insertion | Removal |
| | Pin | Socket | | | | | | | Pin | Socket | | | | | | |
| RG-55B/U, RG-142A/U, RG-142B/U, RG-223/U | 21-33012-21 | 21-33011-21 | 8 | I | 2 | 0.0355 ±0.0010 | 0.218 | 0.280 | 1.156 | 1.144 | M22910/7-17 (B) | M22520/5-05 (A) M22520/5-19 (B) | M22520/10-07 (A) | 11-8676-2 | 11-8369-5 | 11-7880-8 |
| | 21-33012-25 | 21-33011-25 | 8 | II | 4 | | | | | | | | | | 11-8660-5 | 11-8154-1 |
| | 21-33138-21(*) 21-33138-25(*) | 21-33137-21(*) 21-33137-25(*) | 8 | I II | ** | | | | | | | | | | | |
| RG-58C/U, RG-141A/U, RG-303/U | 21-33012-22 | 21-33011-22 | 8 | I | 2 | 0.0355 ±0.0010 | 0.218 | 0.280 | 1.156 | 1.144 | M22910/7-15 (B) | M22520/5-05 (B) M22520/5-41 (B) | M22520/10-07 (B) | 11-8676-2 | 11-8369-4 | 11-7880-8 |
| | 21-33012-26 | 21-33011-26 | 8 | II | 4 | | | | | | | | | | 11-8660-4 | 11-8154-1 |
| | 21-33138-22(*) 21-33138-26(*) | 21-33137-22(*) 21-33137-26(*) | 8 | I II | ** | | | | | | | | | | | |
| RG-59B/U, RG-62A/U, RG-62B/U, RG-210/U | 21-33012-36 | 21-33011-36 | 8 | II | 2 | 0.0355 ±0.0010 | 0.218 | 0.280 | 1.156 | 1.144 | M22910/7-18 (B) | M22520/5-45 (B) | 11-8676-3 | 11-8369-5 | 11-7880-8 | |
| | 21-33038-36* | 21-33037-36 | 8 | II | 4 | | | | | | | | | 11-8660-5 | 11-8154-1 | |
| | 21-33138-36(*) | 21-33137-36(*) | 8 | II | ** | | | | | | | | | | | |
| RG-140/U, RG-302/U | 21-33012-37* | 21-33011-37* | 8 | II | 2 | 0.0355 ±0.0010 | 0.218 | 0.280 | 1.156 | 1.144 | M22910/7-17 (B) | M22520/5-05 (A) M22520/5-19 (B) | M22520/10-07 (A) | 11-8676-2 | 11-8369-5 | 11-7880-8 |
| | 21-33038-37* | 21-33037-37* | 8 | II | 4 | | | | | | | | | | 11-8660-5 | 11-8154-1 |
| | 21-33138-37(*) | 21-33137-37(*) | 8 | II | ** | | | | | | | | | | | |
| RG-161/U, RG-174A/U, RG-179B/U, RG-187A/U, RG-188A/U, RG-316/U | 21-33012-34 | 21-33011-34 | 8 | I | 2 | 0.0355 ±0.0010 | 0.218 | 0.280 | 1.156 | 1.144 | M22910/7-12 (B) | M22520/5-03 (A) M22520/5-08 (A) M22520/5-35 (B) | M22520/10-05 (A) | 11-8676-2 | 11-8369-2 | 11-7880-8 |
| | 21-33012-30 | 21-33011-30 | 8 | II | 4 | | | | | | | | | | 11-8660-2 | 11-8154-1 |
| | 21-33138-34(*) 21-33138-30(*) | 21-33137-34(*) 21-33137-30(*) | 8 | I II | ** | | | | | | | | | | | |
| | 21-33012-1 | 21-33011-1 | 12 | I | 2 | 0.0200 ±0.0005 | 0.128 | 0.172 | 1.092 | 1.072 | M22910/7-11 (B) | M22520/5-03 (B) M22520/5-33 (B) | M22520/10-05 (A) | 11-8676-1 | 11-7880-12 | 11-8154-2 |
| | 21-33012-4 | 21-33011-4 | 12 | II | 4 | | | | | | | | | | 11-8660-2 | 11-8154-2 |
| | 21-33038-1* 21-33038-4 | 21-33037-1* 21-33037-4* | 12 | I II | ** | | | | | | | | | | | |
| 21-33138-1(*) 21-33138-4(*) | 21-33137-1(*) 21-33137-4(*) | 12 | I II | ** | | | | | | | | | | | | |
| RG-178B/U, RG-196A/U | 21-33012-35 | 21-33011-35 | 8 | I | 2 | 0.0355 ±0.0010 | 0.218 | 0.280 | 1.156 | 1.144 | M22910/7-11 (B) | M22520/5-03 (B) M22520/5-33 (B) | M22520/10-05 (A) | 11-8676-2 | 11-7880-8 | 11-8154-1 |
| | 21-33038-35 | 21-33037-35 | 8 | I | 4 | | | | | | | | | | 11-8660-1 | 11-8154-1 |
| | 21-33138-35(*) | 21-33137-35(*) | 8 | I | ** | | | | | | | | | | | |
| | 21-33012-3* | 21-33011-3* | 12 | I | 2 | 0.0200 ±0.0005 | 0.128 | 0.172 | 1.092 | 1.072 | M22910/7-11 (B) | M22520/5-03 (B) M22520/5-33 (B) | M22520/10-05 (A) | 11-8676-1 | 11-8369-1 | 11-7880-8 |
| | 21-33012-5 | 21-33011-5 | 12 | II | 4 | | | | | | | | | | 11-8660-1 | 11-8154-1 |
| 21-33038-3* | 21-33037-3* | 12 | I | 4 | | | | | | | | | | | | |
| 21-33038-5 | 21-33037-5* | 12 | II | ** | | | | | | | | | | | | |
| 21-33138-3(*) 21-33138-5(*) | 21-33137-3(*) 21-33137-5(*) | 12 | I II | ** | | | | | | | | | | | | |

NOTE: Contacts can be ordered by part numbers given in chart

** See finish options for SE crimp Miniature contacts listed on page 44. Replace the parenthesis of the contact part number with the finish suffix number. However, you should consult Amphenol, Sidney, NY regarding the availability of all finish choices for each part number.

* Consult Amphenol, Sidney NY for availability

CRIMPING TOOLS: Italicized letters in parenthesis that follow positioner part numbers indicate applicable die closure. Commercial equivalents with the same die closure dimension may be used.

CHART CONTINUES ON NEXT PAGE

Coaxial Contacts

for miniature cylindrical connectors, cont.
 crimp SE (MIL-MDL-26482 Series 1 type) - application data, cont.

NOTE: All contacts of the same size and the same inner and outer contact diameters (G & H) will mate with each other.

| SE CRIMP COAX CONTACTS | | | | | | | | | | | | | | | | |
|---|-----------------------------|-----------------------------|--------------|---------|------------------------|--------------------|---------------|-----------------------|---------------|---------------------|---|---|------------------------|--|-------------------------|-------------------------|
| For use in Miniature Crimp Type Connectors: PT-SE, SP-SE, and MS/PT-SE Styles | | | | | | | | | | | | | | | | |
| Cable | Contact Part Number | | Contact Size | Type | Finish on Mating Parts | Dimensional Data | | | | Crimp Ferrule Tools | | | Retainer Nut Wrench | Installation Tools | | |
| | | | | | | G Dia. | H Dia. ±0.001 | F Across Flats ±0.004 | L Length Ref. | | MIL-T-22910/7-1 Tool Use with Die Part Number | 47MIL-C-22520/5-01 Tool Use with Die Part Number | | MIL-C-22520/10-0 Tool Use with Die Part Number | Insertion | Removal |
| | Pin | Socket | | | | | | | Pin | Socket | | | | | | |
| RG-180B/U, RG-195A/U | 21-33012-24 | 21-33011-24 | 8 | I | 2 | 0.0355 ± 0.0010 | 0.218 | 0.280 | 1.156 | 1.144 | M22520/7-15 (B) | M22520/5-05 (B) M22520/5-41 (B) | M22520/10-07 (B) | 11-8676-2 | 11-8369-4 11-8660-4 | 11-7880-8 11-8154-1 |
| | 21-33012-46* | 21-33011-46* | 8 | II | 4 | | | | | | | | | | | |
| | 21-33038-24 21-33038-46* | 21-33037-24 21-33037-46* | 8 8 | I II | 4 | | | | | | | | | | | |
| Raychem 9527E1118, RG-180B/U, RG-195A/U | 21-33138-24(*) | 21-33137-24(*) | 8 | I | ** | 0.0200 ± 0.0005 | 0.128 | 0.128 | 0.899 | 0.879 | Daniels GS200 Tool with G2P330 or M22520/31-01 Tool with Positioner M22520/31-02 | 11-8676-2 | 11-8369-4 11-8660-4 | 11-7880-8 11-8154-1 | | |
| | 21-33138-46(*) | 21-33137-46(*) | 8 | II | ** | | | | | | | | | | | |
| RG-188 or RG-316 Double Braid | 21-33012-6* | 21-33011-6* | 12 | I | 2 | 0.0200 ± 0.0005 | 0.128 | 0.172 | 1.092 | 1.072 | M22910/7-13 (B) | M22520/5-37 (B) | 11-8676-1 | 11-8369-2 11-8660-2 | 11-7880-12 11-8154-2 | |
| | 21-33012-7* | 21-33011-7* | 12 | II | 4 | | | | | | | | | | | |
| | 21-33038-6* 21-33038-7* | 21-33037-6* 21-33037-7* | 12 12 | I II | 4 | | | | | | | | | | | |
| Thermax 50C-25A- DS-1 | 21-33138-6(*) | 21-33137-6(*) | 12 | I | ** | 0.0355 ± 0.0010 | 0.128 | 0.280 | 1.156 | 1.144 | M22910/7-13 (B) | M22520/5-37 (B) | 11-8676-2 | 11-8369-4 11-8660-4 | 11-7880-8 11-8154-1 | |
| | 21-33138-7(*) | 21-33137-7(*) | 12 | II | ** | | | | | | | | | | | |
| | 21-33012-44 | 21-33011-44 | 8 | II | 2 | | | | | | | | | | | |
| RG-195 Double Braid | 21-33038-44* | 21-33037-44* | 8 | II | 4 | 0.0355 ± 0.0010 | 0.128 | 0.280 | 1.156 | 1.144 | M22910/7-16 (B) | M22520/5-43 (B) | 11-8676-2 | 11-8369-4 11-8660-4 | 11-7880-8 11-8154-1 | |
| | 21-33138-44(*) | 21-33137-44(*) | 8 | II | ** | | | | | | | | | | | |
| | 21-33012-28 | 21-33011-28 | 8 | I | 2 | | | | | | | | | | | |
| RG-122/U, Raychem 5022E5111 | 21-33038-28* | 21-33037-28* | 8 | I | 4 | 0.0355 ± 0.0010 | 0.128 | 0.280 | 1.156 | 1.144 | M22910/7-16 (B) | M22520/5-43 (B) | 11-8676-2 | 11-8369-4 11-8660-4 | 11-7880-8 11-8154-1 | |
| | 21-33138-28(*) | 21-33137-28(*) | 8 | I | ** | | | | | | | | | | | |
| | 21-33012-23 | 21-33011-23 | 8 | I | 2 | | | | | | | | | | | |
| Raychem 9530D5314 | 21-33012-27 | 21-33011-27 | 8 | II | 2 | 0.0355 ± 0.0010 | 0.218 | 0.280 | 1.156 | 1.144 | M22520/7-15 (B) | M22520/5-05 (B) M22520/5-41 (B) | M22520/10-07 (B) | 11-8676-2 | 11-8369-4 11-8660-4 | 11-7880-8 11-8154-1 |
| | 21-33038-23* | 21-33037-23* | 8 | I | 4 | | | | | | | | | | | |
| | 21-33038-27 | 21-33037-27 | 8 | II | 4 | | | | | | | | | | | |
| Raychem 9527A1317 | 21-33138-23(*) | 21-33137-23(*) | 8 | I | ** | 0.0355 ± 0.0010 | 0.218 | 0.280 | 1.156 | 1.144 | M22910/7-15 (B) | M22520/5-05 (B) M22520/5-41 (B) | M22520/10-07 (B) | 11-8676-2 | 11-8369-4 11-8660-4 | 11-7880-8 11-8154-1 |
| | 21-33138-27(*) | 21-33137-27(*) | 8 | II | ** | | | | | | | | | | | |
| | 21-33012-31 | 21-33011-31 | 8 | I | 2 | | | | | | | | | | | |
| Raychem 7527A1318 | 21-33038-31 | 21-33037-31 | 8 | I | 4 | 0.0355 ± 0.0010 | 0.218 | 0.280 | 1.156 | 1.144 | M22910/7-15 (B) | M22520/5-05 (B) M22520/5-41 (B) | M22520/10-07 (B) | 11-8676-2 | 11-8369-4 11-8660-4 | 11-7880-8 11-8154-1 |
| | 21-33138-31(*) | 21-33137-31(*) | 8 | I | ** | | | | | | | | | | | |
| | 21-33012-39 | 21-33011-39 | 8 | II | 2 | | | | | | | | | | | |
| Westrex 199-49-1, Tensolite 30850/87T-1 | 21-33038-39* | 21-33037-39* | 8 | II | 4 | 0.0355 ± 0.0010 | 0.218 | 0.280 | 1.156 | 1.144 | M22910/7-12 (B) | M22520/5-03 (A) M22520/5-08 (A) M22520/5-35 (B) | M22520/10-05 (A) | 11-8676-2 | 11-8369-2 11-8660-2 | 11-7880-8 11-8154-1 |
| | 21-33138-39(*) | 21-33137-39(*) | 8 | II | ** | | | | | | | | | | | |
| | 21-33012-40* | 21-33011-40 | 8 | II | 2 | | | | | | | | | | | |
| Westrex 199-49-1, Tensolite 30850/87T-1 | 21-33038-40* | 21-33037-40* | 8 | II | 4 | 0.0200 ± 0.0005 | 0.128 | 0.172 | 1.092 | 1.072 | M22910/7-11 (B) | M22520/5-03 (B) M22520/5-33 (B) | M22520/10-05 (B) | 11-8676-1 | 11-8369-1 11-8660-1 | 11-7880-12 11-8154-2 |
| | 21-33138-40* | 21-33137-40(*) | 8 | II | ** | | | | | | | | | | | |
| | 21-33012-43 | 21-33011-43 | 12 | II | 2 | | | | | | | | | | | |
| Westrex 199-49-1, Tensolite 30850/87T-1 | 21-33038-43 | 21-33037-43 | 12 | II | 4 | 0.0200 ± 0.0005 | 0.128 | 0.172 | 1.092 | 1.072 | M22910/7-11 (B) | M22520/5-03 (B) M22520/5-33 (B) | M22520/10-05 (B) | 11-8676-1 | 11-8369-1 11-8660-1 | 11-7880-12 11-8154-2 |
| | 21-33138-43(*) | 21-33137-43(*) | 12 | II | ** | | | | | | | | | | | |

NOTE: Contacts can be ordered by part numbers given in chart

** See finish options for SE crimp Miniature contacts listed on page 44. Replace the parenthesis of the contact part number with the finish suffix number. However, you should consult Amphenol, Sidney, NY regarding the availability of all finish choices for each part number.

* Consult Amphenol, Sidney NY for availability

CRIMPING TOOLS: Italicized letters in parenthesis that follow positioner part numbers indicate applicable die closure. Commercial equivalents with the same die closure dimension may be used.

Mounting Recommendations for miniature cylindrical connectors

FLANGE MOUNTED CONNECTORS

All flange mounting PT connectors use standard MS mounting dimensions. They cannot be back panel mounted due to coupling clearance. The PTB (thru-bulkhead) type connector must also be back panel mounted on one side. Flange gaskets are available for both series, see page 37.

| Shell Size | R (TP) | | D Dia. | |
|------------|--------|-------|--------|-------|
| | PT | SP | PT | SP |
| 6 | .469 | .641 | .323 | .439 |
| 8 | .594 | .734 | .449 | .563 |
| 10 | .719 | .812 | .573 | .680 |
| 12 | .812 | .938 | .699 | .859 |
| 14 | .906 | 1.031 | .823 | .984 |
| 16 | .969 | 1.125 | .949 | 1.108 |
| 18 | 1.062 | 1.203 | 1.073 | 1.233 |
| 20 | 1.156 | 1.297 | 1.199 | 1.358 |
| 22 | 1.250 | 1.375 | 1.323 | 1.483 |
| 24 | 1.375 | — | 1.449 | — |

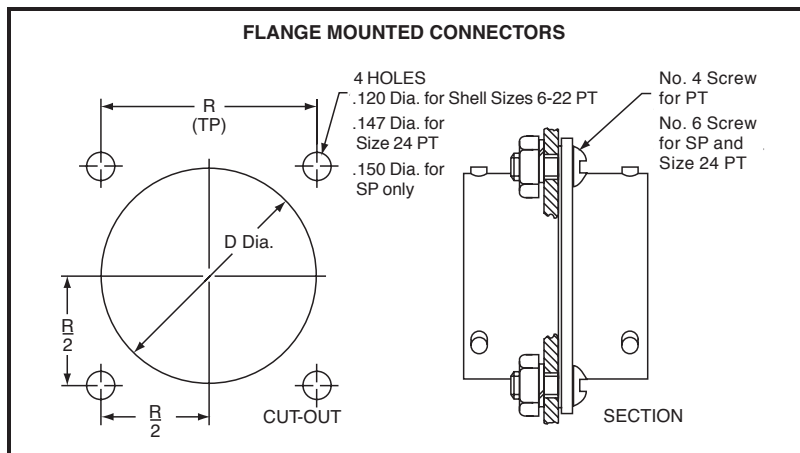

JAM NUT MOUNTINGS

The jam nut design has become very popular because it allows bench wiring of harness assemblies. The labor saving often offsets the added cost of the jam nut receptacle which is due to the self contained "O" ring and the extra nut.

| Shell Size | R +.010 -.000 | B +.000 -.010 | F ±.010 | P Panel Thickness | |
|------------|---------------------|---------------------|------------|----------------------|------|
| | | | | Min. | Max. |
| 6 | .447 | .420 | .286 | .062 | .125 |
| 8 | .572 | .542 | .331 | .062 | .125 |
| 10 | .697 | .669 | .375 | .062 | .125 |
| 12 | .884 | .830 | .442 | .062 | .125 |
| 14 | 1.007 | .955 | .486 | .062 | .125 |
| 16 | 1.134 | 1.084 | .530 | .062 | .125 |
| 18 | 1.259 | 1.208 | .573 | .062 | .125 |
| 20 | 1.384 | 1.333 | .641 | .062 | .250 |
| 22 | 1.507 | 1.459 | .685 | .062 | .250 |
| 24 | 1.634 | 1.575 | — | .062 | .250 |

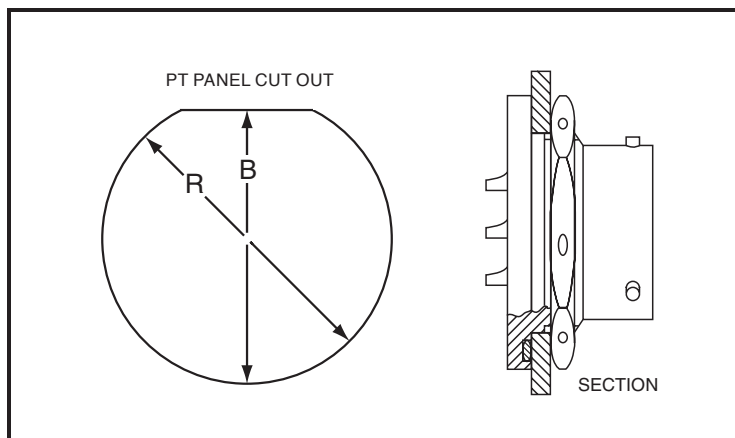

HERMETIC RECEPTACLE MOUNTINGS

This series must be mounted in such a way as to preserve the

hermetic seal provided by the glass insert. Mounting data for box and jam nut receptacles is given above. Cut-out required for solder mounting receptacles (N) is given below.

| Shell Size | N Max. |
|------------|--------|
| 6 | .458 |
| 8 | .582 |
| 10 | .692 |
| 12 | .801 |
| 14 | .926 |
| 16 | 1.051 |
| 18 | 1.176 |
| 20 | 1.395 |
| 22 | 1.375 |
| 24 | 1.520 |

The finish of each of these hermetic receptacles is fused electro-deposited tin for easy solderability, and protected by a special lacquer for optimum shelf life. The lacquer will not interfere with any soldering operation. Low temperature solder should be used and the addition of a solder fillet at arrow points on drawing at right is recommended. Care must be taken that the operating temperature of the final assembly does not rise above the melting point of tin (440° F).

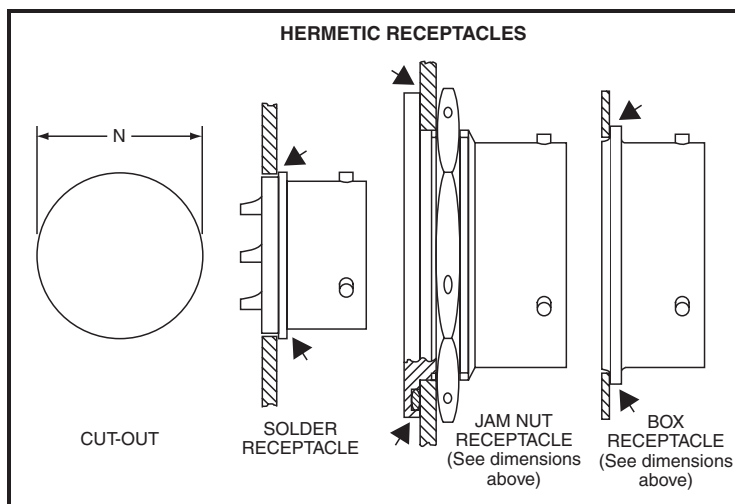

Other Amphenol Miniature Cylindrical Connectors

Geophysical Miniature Cylindricals

Designed for the Geophysical industry's rugged environments, the Amphenol® RPT Series connector has custom features that provide reliability in extreme temperature and moisture conditions.

The unique shell design provides stronger shells along with an anodized (nonconductive) finish for greater salt, corrosion and abrasion resistance. Coupling nuts are manufactured with round detent holes and are sold separately for greater customer flexibility. See product data sheet #146.

RJ Field Bayonet Cylindricals

Amphenol PCD division provides MIL-DTL-26482 bayonet coupling cylindrical connectors with an RJ45 Ethernet interface*. These are designed for use in all levels of harsh environments from industrial to mil-aero applications providing IP67 protection from dust, fluids, vibration, shock and traction. The Amphenol® RJ Field allows the use of Ethernet Class D/Cat 5 and Cat 5e connections for 10 BaseT, 100 Base TX, or 1000 BaseT networks. It works with any standard RJ45 cordset with no extra tooling. It also offers reinforced EMI protection.

For more information go online to www.rjfield.com or ask for the Field Series brochure.

* RJ Field Bayonet and other Field Series products are available through Amphenol PCD. These include RJF TV within MIL-DTL-38999 Series III threaded coupling connectors, and RJF 544 within ECTA push-pull plastic shell coupling.



**Amphenol® RPT
Miniature Cylindricals**



**RJ Field Bayonet
Cylindricals**



AMPHENOL CORPORATION
Amphenol Industrial

Phone: 888-364-9011

191 Delaware Avenue

Sidney, NY 13838-1395

www.amphenol-industrial.com

Notice: Specifications are subject to change without notice. Contact your nearest Amphenol Corporation Sales Office for the latest specifications. All statements, information and data given herein are believed to be accurate and reliable but are presented without guarantee, warranty, or responsibility of any kind expressed or implied. Statements or suggestions concerning possible use of our products are made without representation or warranty that any such use is free of patent infringement and are not recommendations to infringe any patent. The user should not assume that all safety measures are indicated or that other measures may not be required. Specifications are typical and may not apply to all connectors.