

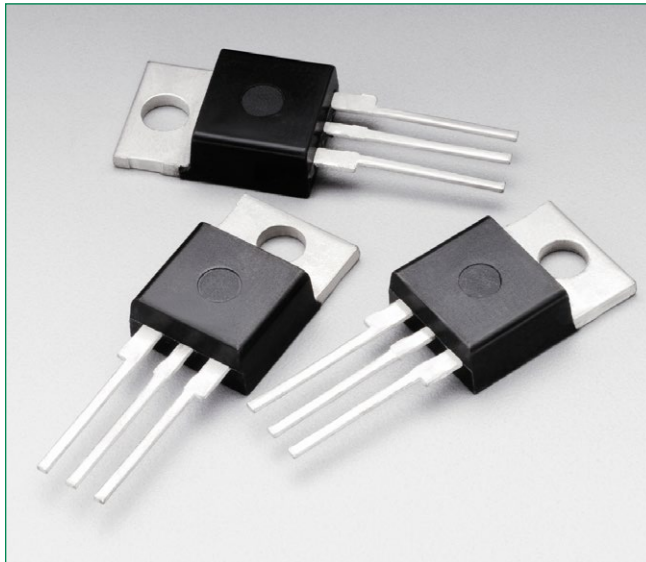

2N6344A, 2N6348A, 2N6349A



Description

Designed primarily for full-wave AC control applications, such as light dimmers, motor controls, heating controls and power supplies; or wherever full-wave silicon gate controlled solid-state devices are needed. Triac type thyristors switch from a blocking to a conducting state for either polarity of applied anode voltage with positive or negative gate triggering.

Features

- Blocking Voltage to 800 V
- All Diffused and Glass Passivated Junctions for Greater Parameter Uniformity and Stability
- Small, Rugged, Thermowatt Construction for Low Thermal Resistance, High Heat Dissipation and Durability
- Gate Triggering Guaranteed in all Four Quadrants
- For 400 Hz Operation, Consult Factory
- 8.0 A Devices Available as 2N6344 thru 2N6349
- Pb-Free Package is Available

Pin Out

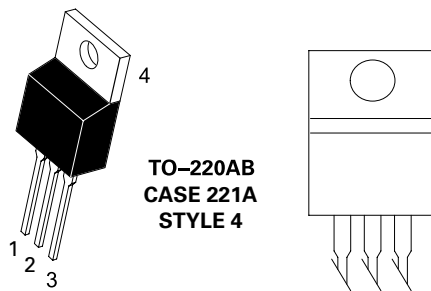

Functional Diagram

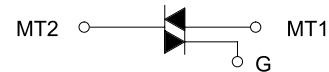

Additional Information



Datasheet



Resources



Samples

Maximum Ratings and Thermal Characteristics ($T_J = 25^\circ\text{C}$ unless otherwise noted)

Rating	Symbol	Value	Unit
Peak Repetitive Off-State Voltage (Note 1) ($T_J = -40$ to 110°C , Sine Wave, 50 to 60 Hz, Gate Open)	2N6344A, 2N6348A	V_{DRM}^ V_{RRM}	600 V
	2N6349A		800
*On-State RMS Current (Full Cycle Sine Wave 50 to 60 Hz)	($T_C = +80^\circ\text{C}$)	I_T (RMS)	12 A
	($T_C = +90^\circ\text{C}$)		6.0
*Peak Non-Repetitive Surge Current (One Full Cycle, Sine Wave 60 Hz, $T_C = +80^\circ\text{C}$) Preceded and followed by rated current	I_{TSM}	100	A
Circuit Fusing Considerations ($t = 8.3$ ms)	I^2t	59	A^2s
*Peak Gate Power ($T_C = +80^\circ\text{C}$, Pulse Width = 2 μs)	P_{GM}	20	W
*Average Gate Power ($T_C = +80^\circ\text{C}$, $t = 8.3$ ms)	$P_{G(AV)}$	0.5	W
*Peak Gate Current ($T_C = +80^\circ\text{C}$, Pulse Width = 2.0 μs)	I_{GM}	2.0	A
*Peak Gate Voltage ($T_C = +80^\circ\text{C}$, Pulse Width = 2.0 μs)	V_{GM}	± 10	V
*Operating Junction Temperature Range	T_J	-40 to +150	$^\circ\text{C}$
*Storage Temperature Range	T_{stg}	-40 to +150	$^\circ\text{C}$

Stresses exceeding Maximum Ratings may damage the device. Maximum Ratings are stress ratings only. Functional operation above the Recommended Operating Conditions is not implied. Extended exposure to stresses above the Recommended Operating Conditions may affect device reliability.

* Indicates JEDEC Registered Data.

1. V_{DRM}^* and V_{RRM} for all types can be applied on a continuous basis. Blocking voltages shall not be tested with a constant current source such that the voltage ratings of the devices are exceeded.

Thermal Characteristics

Rating	Symbol	Value	Unit
† Thermal Resistance, Junction to Case	R_{BJC}	2.0	$^\circ\text{C}/\text{W}$
Maximum Lead Temperature for Soldering Purposes, 1/8" from case for 10 seconds	T_L	260	$^\circ\text{C}$

† Indicates JEDEC Registered Data.

Electrical Characteristics - OFF ($T_C = 25^\circ\text{C}$ unless otherwise noted; Electricals apply in both directions)

Characteristic	Symbol	Min	Typ	Max	Unit
Peak Repetitive Blocking Current ($V_D = V_{DRM} = V_{RRM}^$; Gate Open)	I_{DRM}^* I_{RRM}	-	-	1.0	μA
		-	-	2.0	mA

Electrical Characteristics - ON ($T_c = 25^\circ\text{C}$ unless otherwise noted; Electricals apply in both directions)

Characteristic	Symbol	Min	Typ	Max	Unit	
†Peak On-State Voltage ($I_{TM} = \pm 17\text{ A Peak}$; Pulse Width = 1 to 2 ms, Duty Cycle $\leq 2\%$)	V_{TM}	-	1.3	175	V	
Gate Trigger Current (Continuous dc) ($V_D = 12\text{ Vdc}$, $R_L = 100\ \Omega$)						
Quadrant I: MT2(+), G(+)	I_{GT}	-	6.0	50	mA	
Quadrant II: MT2(+), G(-)		2N6348A & 2N6349A	-	6.0		75
Quadrant III: MT2(-), G(-)		All	-	10		50
Quadrant IV: MT2(-), G(+)		2N6348A & 2N6349A	-	25		75
†MT2(+), G(+); MT2(-), G(-)		$T_c = -40^\circ\text{C}$	-	-		100
†MT2(+), G(-); MT2(-), G(+)		$T_c = -40^\circ\text{C}$	-	-		125
Gate Trigger Voltage (Continuous dc) ($V_D = 12\text{ Vdc}$, $R_L = 100\ \Omega$)						
Quadrant I: MT2(+), G(+)	V_{GT}	-	0.9	2.0	V	
Quadrant II: MT2(+), G(-)		2N6349 only	-	0.9		2.5
Quadrant III: MT2(-), G(-)		Both	-	1.1		2.0
Quadrant IV: MT2(-), G(+)		2N6349 only	-	1.4		2.5
†MT2(+), G(+); MT2(-), G(-) $T_c = -40^\circ\text{C}$		$T_c = -40^\circ\text{C}$	-	-		2.5
†MT2(+), G(-); MT2(-), G(+) $T_c = -40^\circ\text{C}$		$T_c = -40^\circ\text{C}$	-	-		3.0
Gate Non-Trigger Voltage (Continuous dc) ($V_D = \text{Rated } V_{DRM}$, $R_L = 10\text{ k}\ \Omega$, $T_J = 100^\circ\text{C}$)	V_{GD}	.02	-	-		
†MT2(+), G(+); MT2(-), G(-); MT2(+), G(-); MT2(-), G(-)	I_H	$T_c = 25^\circ\text{C}$	-	6.0	mA	
		$T_c = -40^\circ\text{C}$	-	-		75
†Turn-On Time ($V_D = \text{Rated } V_{DRM}$, $I_{TM} = 11\text{ A}$, $I_{GT} = 120\text{ mA}$, Rise Time = 0.1 μs , Pulse Width = 2 μs)	t_{gt}	-	1.5	2.0	μs	

† Indicates JEDEC Registered Data.

Dynamic Characteristics

Characteristic	Symbol	Min	Typ	Max	Unit
Critical Rate of Rise of Commutation Voltage ($V_D = \text{Rated } V_{DRM}$, $I_{TM} = 17\text{ A}$, Commutating $di/dt = 6.1\text{ A/ms}$, Gate Unenergized, $T_c = 80^\circ\text{C}$)	$dv/dt(c)$	-	5.0	-	V/ μs

Voltage Current Characteristic of SCR

Symbol	Parameter
V_{DRM}	Peak Repetitive Forward Off State Voltage
I_{DRM}	Peak Forward Blocking Current
V_{RRM}	Peak Repetitive Reverse Off State Voltage
I_{RRM}	Peak Reverse Blocking Current
V_{TM}	Maximum On State Voltage
I_H	Holding Current

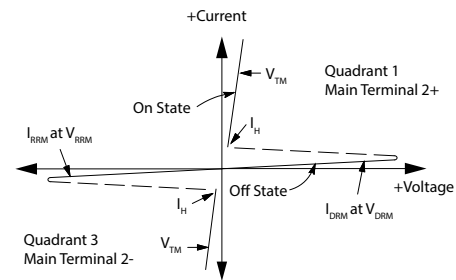

Ratings and Characteristic Curves

Figure 1. RMS Current Derating

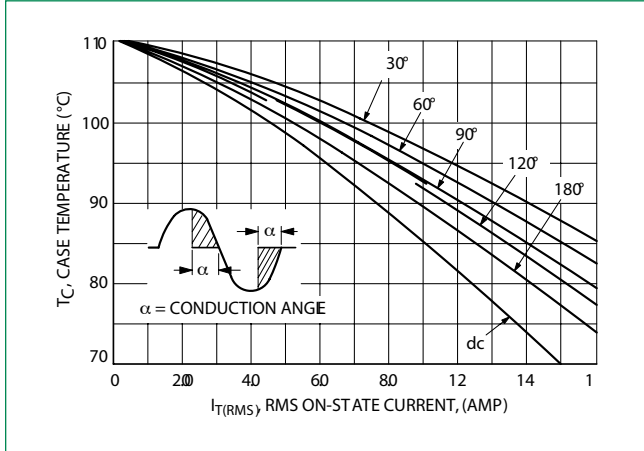

Figure 2. On-State Power Dissipation

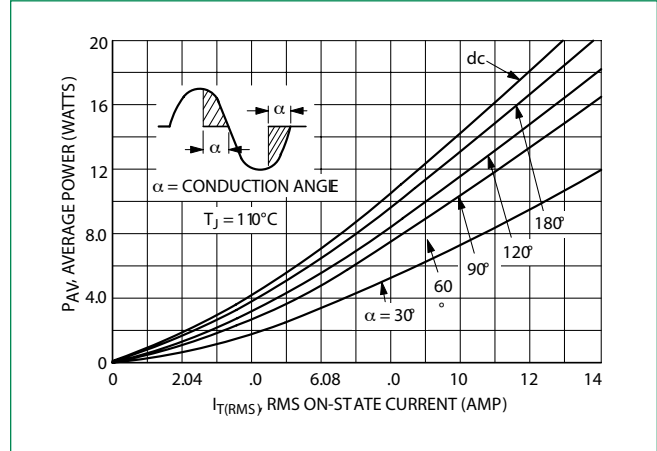

Figure 3. Typical Gate Trigger Voltage

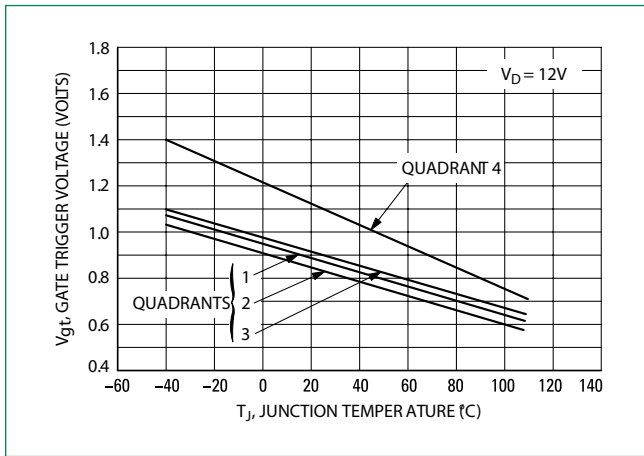

Figure 4. Typical Gate Trigger Current

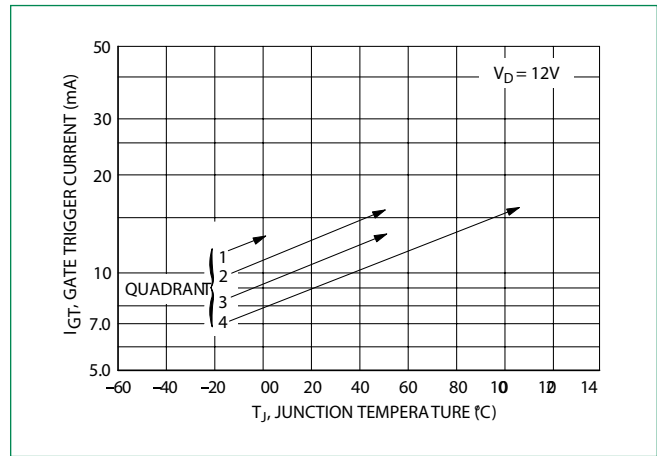

Figure 7. Maximum On-State Characteristics

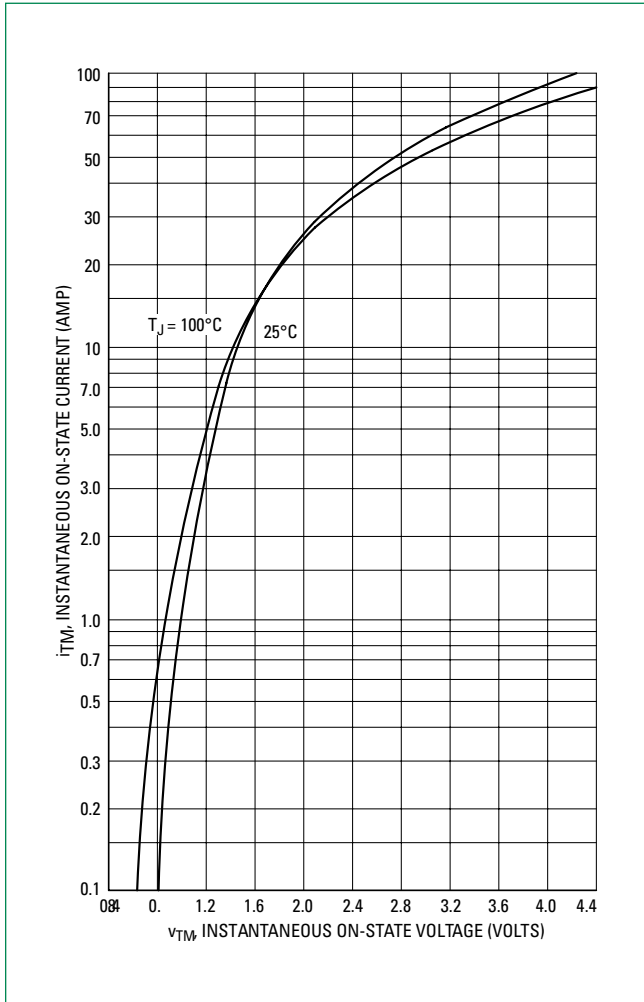

Figure 8. Typical Holding Current

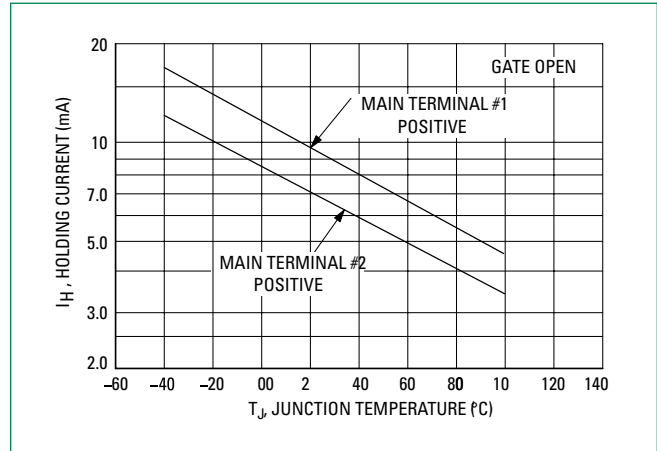

Figure 9. Maximum Allowable Surge Current

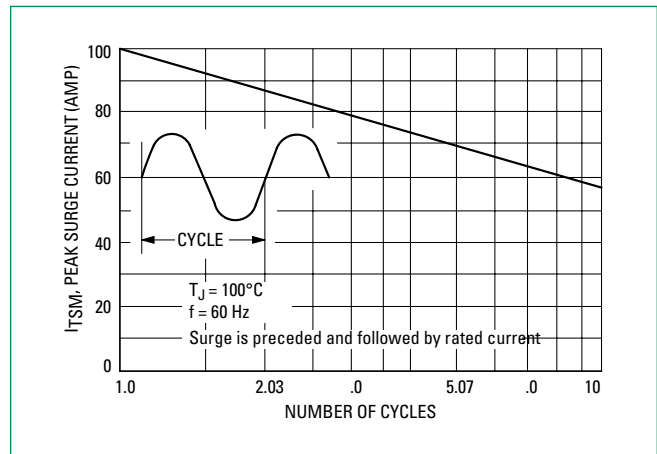
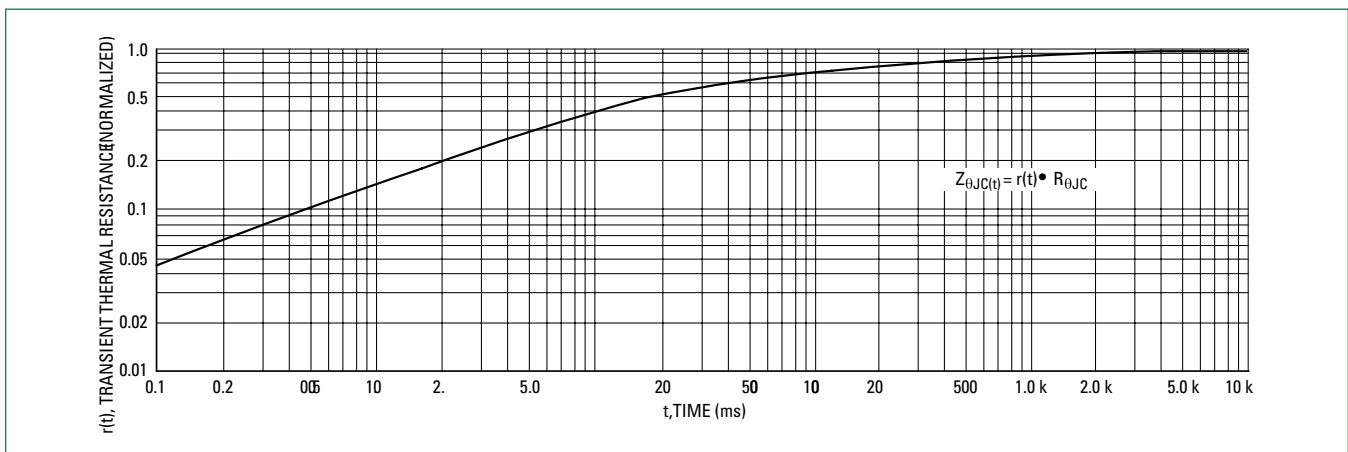
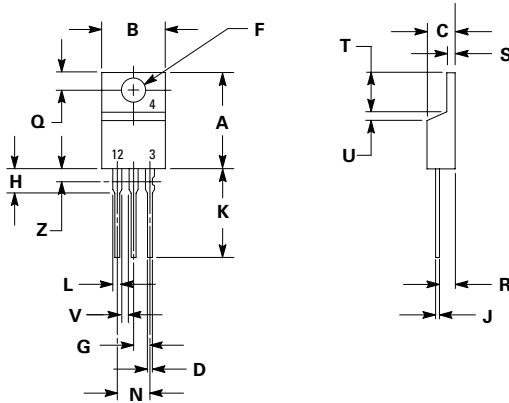

Figure 10. Typical Thermal Response



Dimensions



Part Marking System

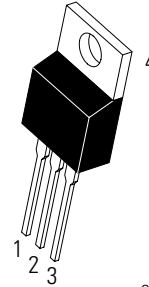

**TO-220AB
Case 221A
Style 3**



2N634xA =Device Code
Y =Year
M =Month
A =Assembly Site
AKA =Diode Polarity
G =Pb-Free Package

Dim	Inches		Millimeters	
	Min	Max	Min	Max
A	0.590	0.620	14.99	15.75
B	0.380	0.420	9.65	10.67
C	0.178	0.188	4.52	4.78
D	0.025	0.035	0.64	0.89
F	0.142	0.147	3.61	3.73
G	0.095	0.105	2.41	2.67
H	0.110	0.130	2.79	3.30
J	0.018	0.024	0.46	0.61
K	0.540	0.575	13.72	14.61
L	0.060	0.075	1.52	1.91
N	0.195	0.205	4.95	5.21
Q	0.105	0.115	2.67	2.92
R	0.085	0.095	2.16	2.41
S	0.045	0.060	1.14	1.52
T	0.235	0.255	5.97	6.47
U	0.000	0.050	0.00	1.27
V	0.045	---	1.15	---
Z	---	0.080	---	2.04

1. DIMENSIONING AND TOLERANCING PER ANSI Y14.5M, 1982.
2. CONTROLLING DIMENSION: INCH.
3. DIMENSION Z DEFINES A ZONE WHERE ALL BODY AND LEAD IRREGULARITIES ARE ALLOWED.

Pin Assignment

1	Cathode
2	Anode
3	Gate
4	Anode

Ordering Information

Device	Package	Shipping†
2N6344A	TO-220AB	500 Units / Box
2N6344AG	TO-220AB (Pb-Free)	
2N6348A	TO-220AB	
2N6348AG	TO-220AB (Pb-Free)	
2N6349A	TO-220AB	
2N6349AG	TO-220AB (Pb-Free)	

Disclaimer Notice - Information furnished is believed to be accurate and reliable. However, users should independently evaluate the suitability of and test each product selected for their own applications. Littelfuse products are not designed for, and may not be used in, all applications. Read complete Disclaimer Notice at <http://www.littelfuse.com/disclaimer-electronics>.