

SPECIFICATION

PATENT PENDING

- Part No. : **MB.TG30.A.305111**
- Product Name : Apex Magforce Magnetic Mount LTE Antenna
with 3 meter Low Loss Cable
- Feature : High Efficiency and Peak Gain
Worldwide 4G/3G/2G
LTE / GSM / CDMA /DCS /PCS / WCDMA / UMTS / HSDPA /
GPRS / EDGE /GPS /Wi-Fi
698MHz to 960MHz, 1575.42MHz
1710MHz to 2700Mhz
Straight Fixed Dipole Terminal Antenna
Strong Magnetic Bond to Metal Surfaces
3 Meters CFD-200 Low Loss Coaxial Cable
SMA(M) Connector
Cable length and connector customizable
RoHS Compliant



1. Introduction

The Apex Magforce MB.TG30.A.305111 Magnetic Mounted LTE Antenna with cable and connector is primarily designed for use with 4G LTE modules that require highest possible efficiency and peak gain to deliver best in class throughput on all major LTE bands worldwide for terminal applications. The antenna can be easily mounted on any metal plate.

This Magnetic Mount LTE antenna utilizes the highly successful TG.30 antenna as its main element, providing an ultra wide-band response so it can also be used for other cellular and wireless applications such as fallback to 3G, WI-FI, and assisted GPS. With its unique ultra-wideband dipole design, best in industry performance characteristics is provided, with up to 90% efficiency. It is the recommended solution for products that require highest standard network certifications. The radiation patterns are Omni-directional and stable across all bands.

It has a quality robust IP67 housing (connector and magnetic base is IP65) for use with wireless devices. The antenna comes as standard with 3 meters CFD-200 low loss coaxial cable and a SMA male connector. A super magnet in the base provides a strong magnetic bond (max magnetic Pull Force 2.92kgf) to the metal surface it is mounted on.

Cable length and connector type are customizable for a minimum order quantity. Contact your regional Taoglas office for support.

2. Specification

ELECTRICAL								
Frequency (MHz)	700~800	824~896	880~960	1575.42	1710 ~ 1880	1850 ~ 1990	1710 ~ 2170	2400~2800
Efficiency (%)	77.54	61.02	50.99	46.55	48.09	44.77	43.68	41.44
Peak Gain (dBi)	2.97	1.45	0.62	1.61	1.23	1.19	1.23	2.84
Average Gain (dBi)	-1.14	-2.16	-2.95	-3.32	-3.22	-3.50	-3.61	-3.84
Return Loss (dB)	<-5	<-6	<-5	<-10	<-5	<-5	<-5	<-5
Impedance	50Ω							
Polarization	Linear							
Radiation Pattern	Omni							
Input Power	50W							
MECHANICAL								
Casing	ABS							
Cable type	CFD-200							
Cable Length	3 Meters, Standard							
Connector	SMA Male, Standard							
Weight	Antenna Main Body:40g				Magnetic Mounted Base:370g			
Water Proof	IP67 for Antenna Casing, IP65 for Total part							
Magnetic Pulling Force	2.92Kgf							
ENVIRONMENTAL								
Storage Temperature Range	-40°C to 85°C							
Operation Temperature Range	-40°C to 85°C							
Humidity	Non-condensing 65°C 95% RH							

LTE BANDS			
Band Number	LTE / LTE-Advanced / WCDMA / HSPA / HSPA+ / TD-SCDMA		
	Uplink	Downlink	Covered
1	UL: 1920 to 1980	DL: 2110 to 2170	✓
2	UL: 1850 to 1910	DL: 1930 to 1990	✓
3	UL: 1710 to 1785	DL: 1805 to 1880	✓
4	UL: 1710 to 1755	DL: 2110 to 2155	✓
5	UL: 824 to 849	DL: 869 to 894	✓
7	UL: 2500 to 2570	DL: 2620 to 2690	✓
8	UL: 880 to 915	DL: 925 to 960	✓
9	UL: 1749.9 to 1784.9	DL: 1844.9 to 1879.9	✓
11	UL: 1427.9 to 1447.9	DL: 1475.9 to 1495.9	✗
12	UL: 699 to 716	DL: 729 to 746	✓
13	UL: 777 to 787	DL: 746 to 756	✓
14	UL: 788 to 798	DL: 758 to 768	✓
17	UL: 704 to 716	DL: 734 to 746 (LTE only)	✓
18	UL: 815 to 830	DL: 860 to 875 (LET only)	✓
19	UL: 830 to 845	DL: 875 to 890	✓
20	UL: 832 to 862	DL: 791 to 821	✓
21	UL: 1447.9 to 1462.9	DL: 1495.9 to 1510.9	✗
22	UL: 3410 to 3490	DL: 3510 to 3590	✗
23	UL: 2000 to 2020	DL: 2180 to 2200 (LTE only)	✓
24	UL: 1625.5 to 1660.5	DL: 1525 to 1559 (LTE only)	✓
25	UL: 1850 to 1915	DL: 1930 to 1995	✓
26	UL: 814 to 849	DL: 859 to 894	✓
27	UL: 807 to 824	DL: 852 to 869 (LTE only)	✓
28	UL: 703 to 748	DL: 758 to 803 (LTE only)	✓
29	UL: -	DL: 717 to 728 (LTE only)	✓
30	UL: 2305 to 2315	DL: 2350 to 2360 (LTE only)	✓
31	UL: 452.5 to 457.5	DL: 462.5 to 467.5 (LTE only)	✗
32	UL: -	DL: 1452 - 1496	✗
35		1850 to 1910	✓
38		2570 to 2620	✓
39		1880 to 1920	✓
40		2300 to 2400	✓
41		2496 to 2690	✓
42		3400 to 3600	✗
43		3600 to 3800	✗

3. Antenna Characteristics

3.1 Return Loss

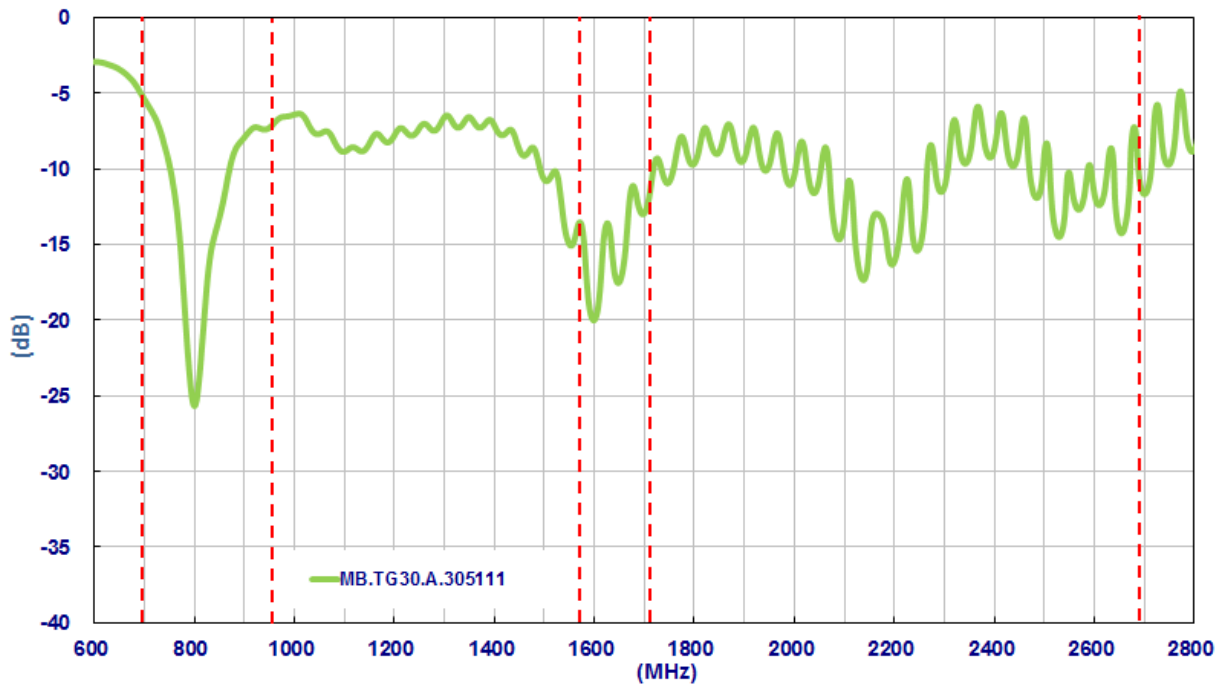

3.2 Peak Gain

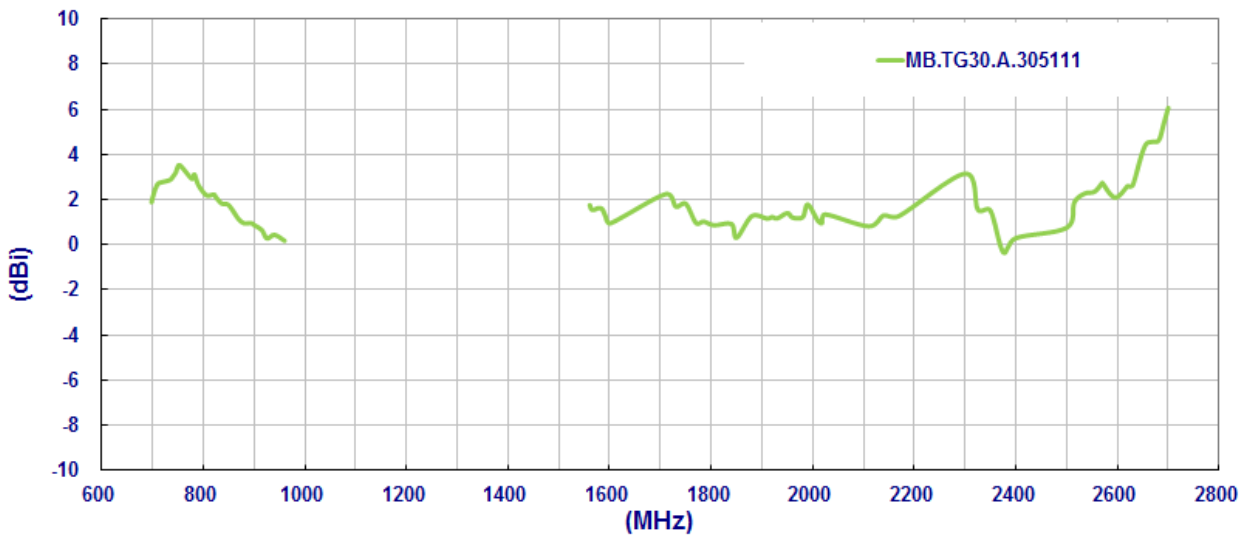

3.3 Average Gain

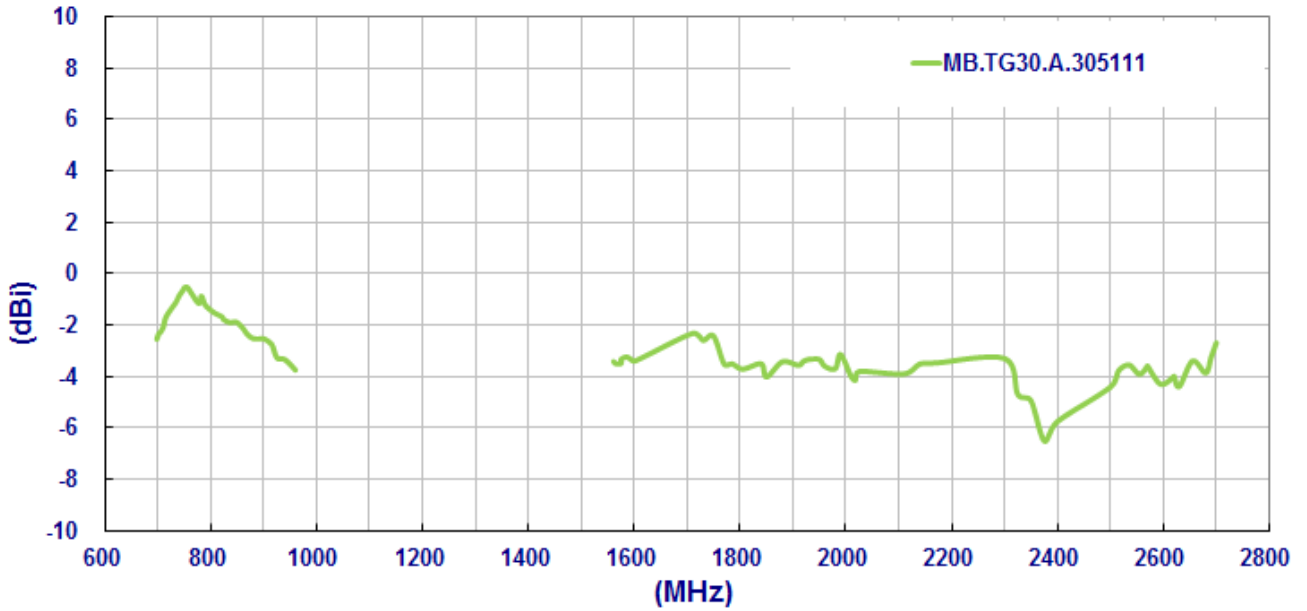

3.4 Efficiency

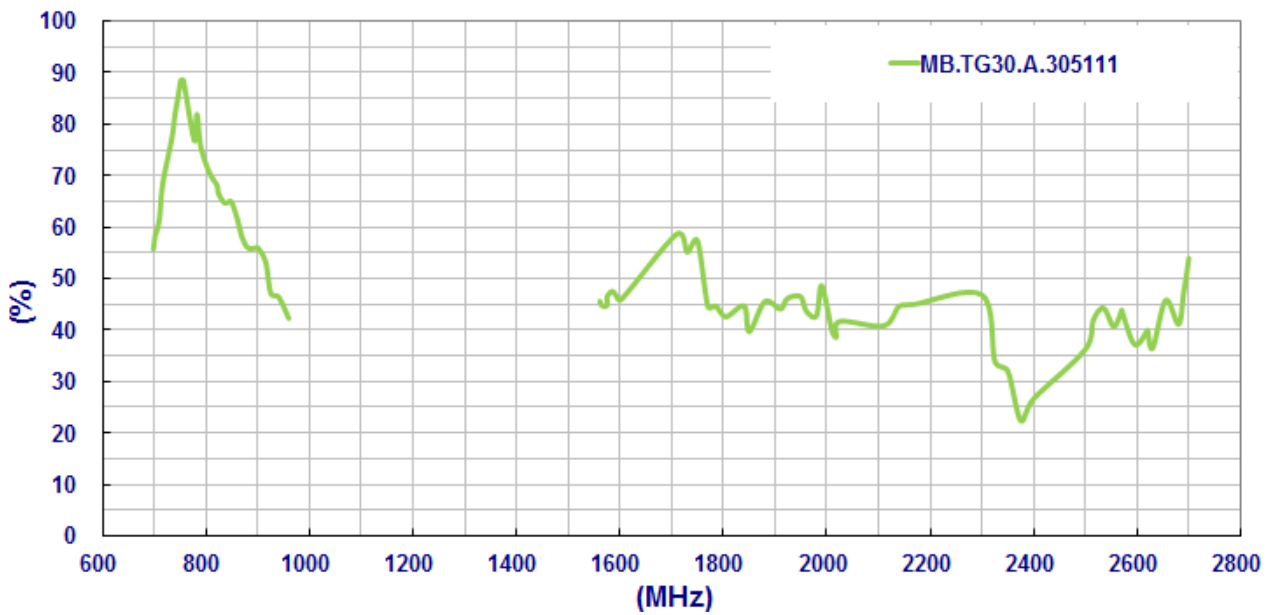

4. Antenna Radiation Patterns

4.1 Antenna setup (Free Space Straight)

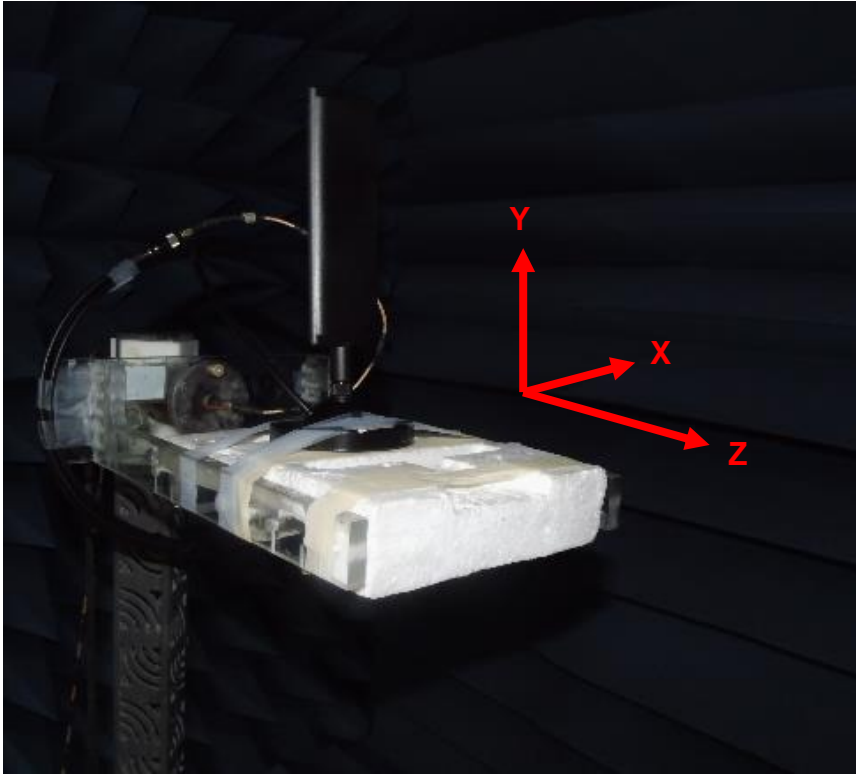

4.2 Radiation Patterns

XY plane

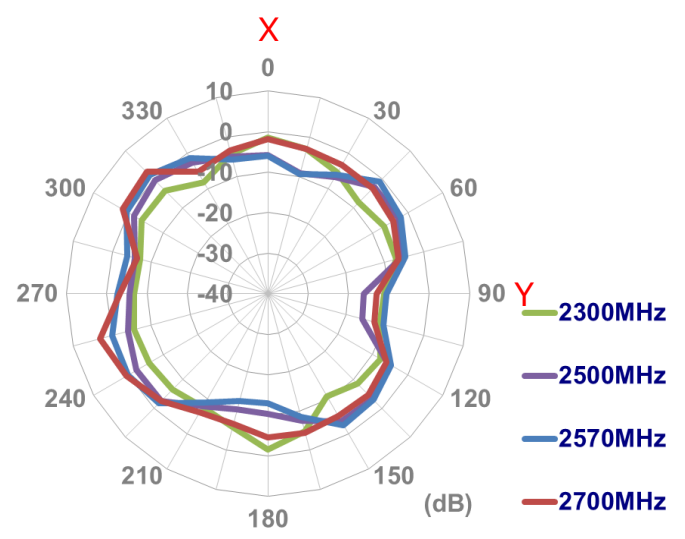
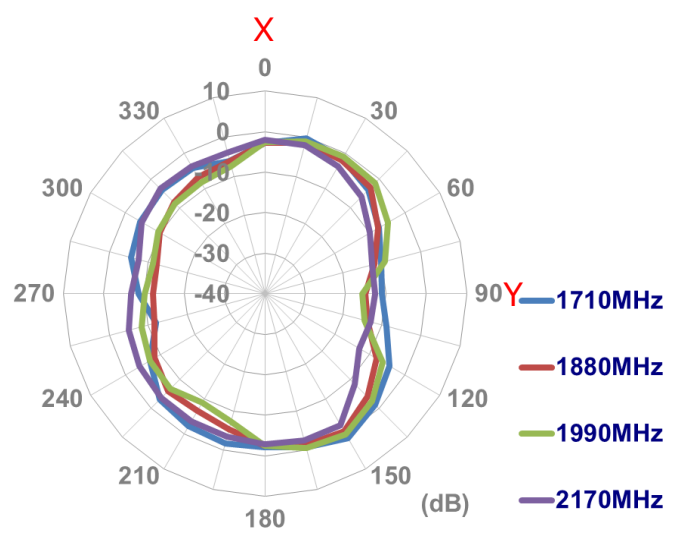
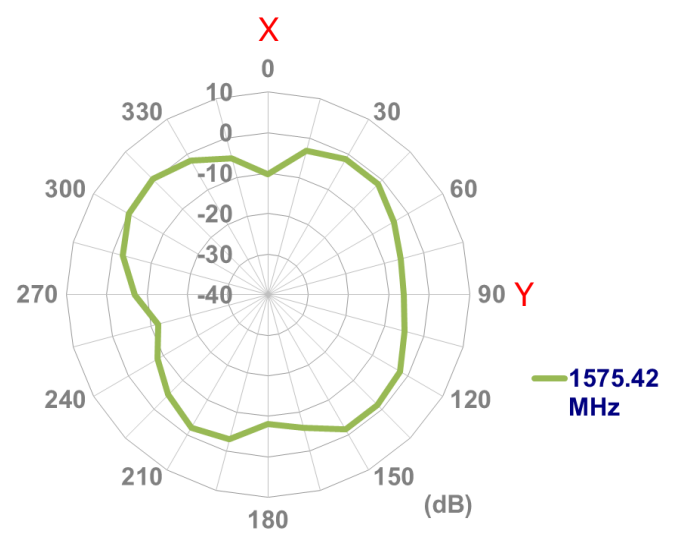
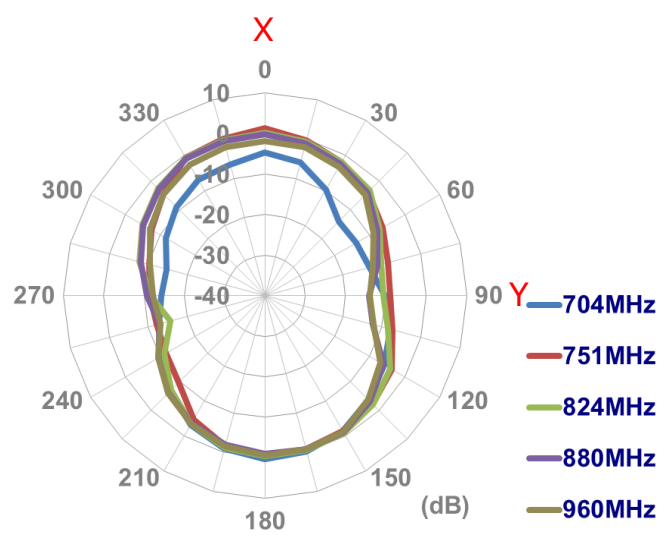

XZ plane

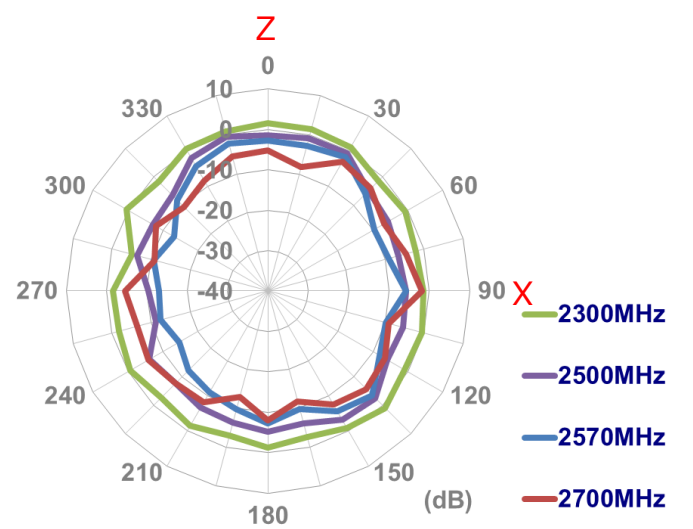
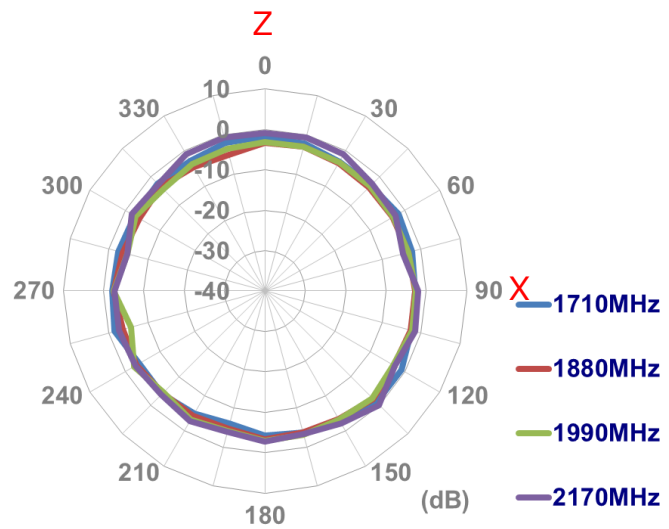
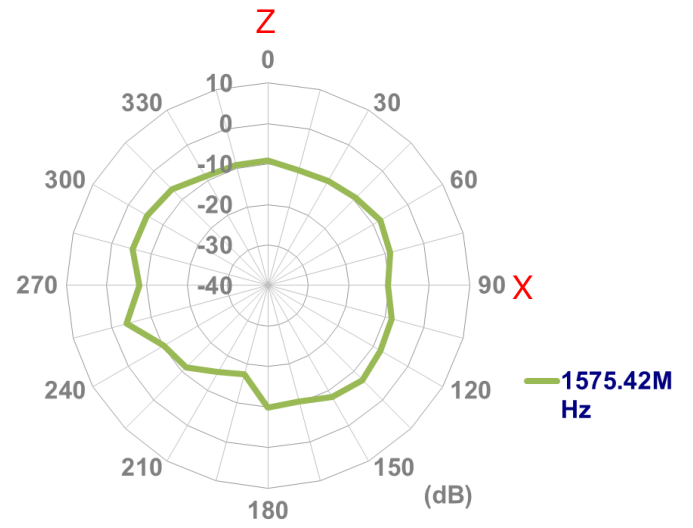
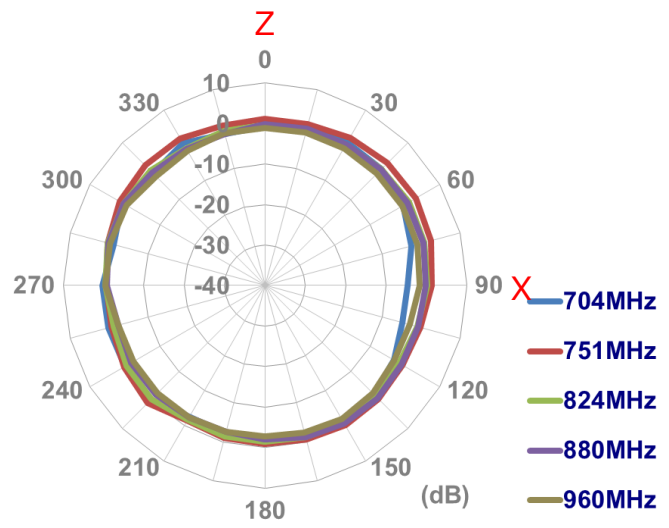

YZ plane

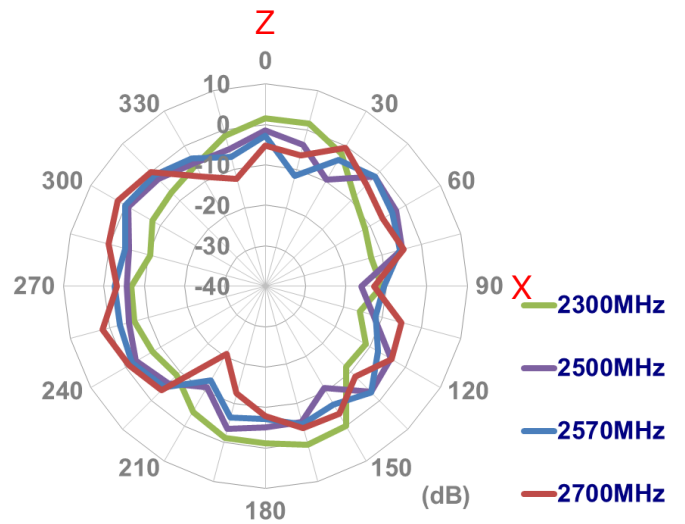
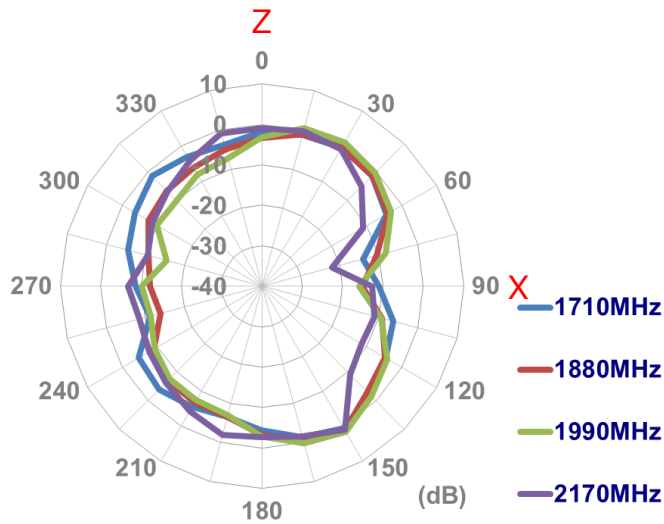
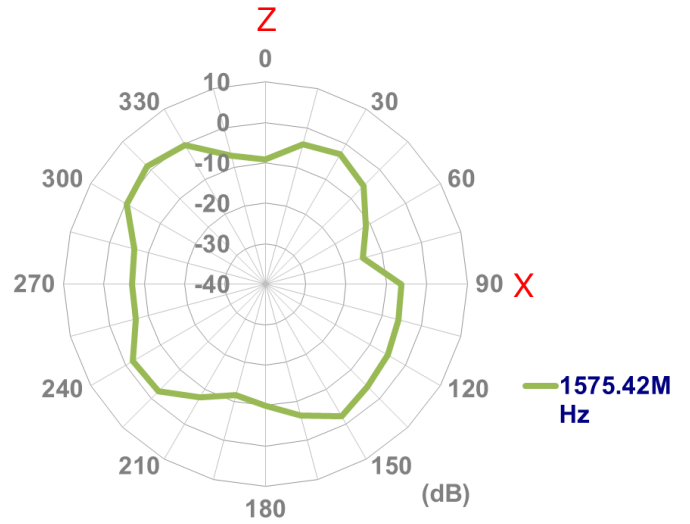
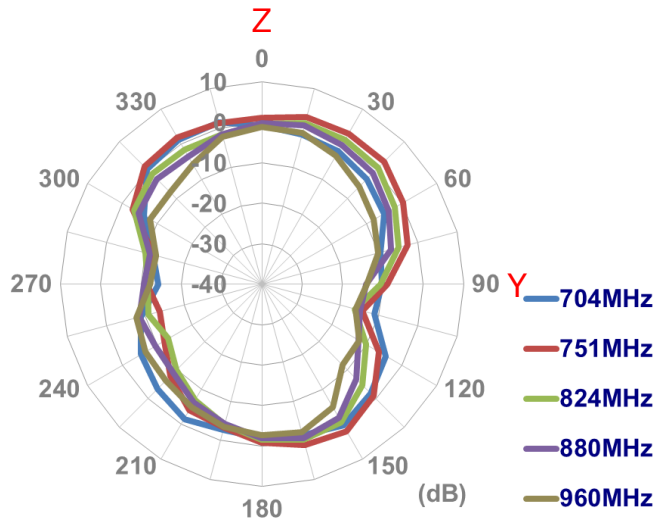

5. Mechanical Drawing

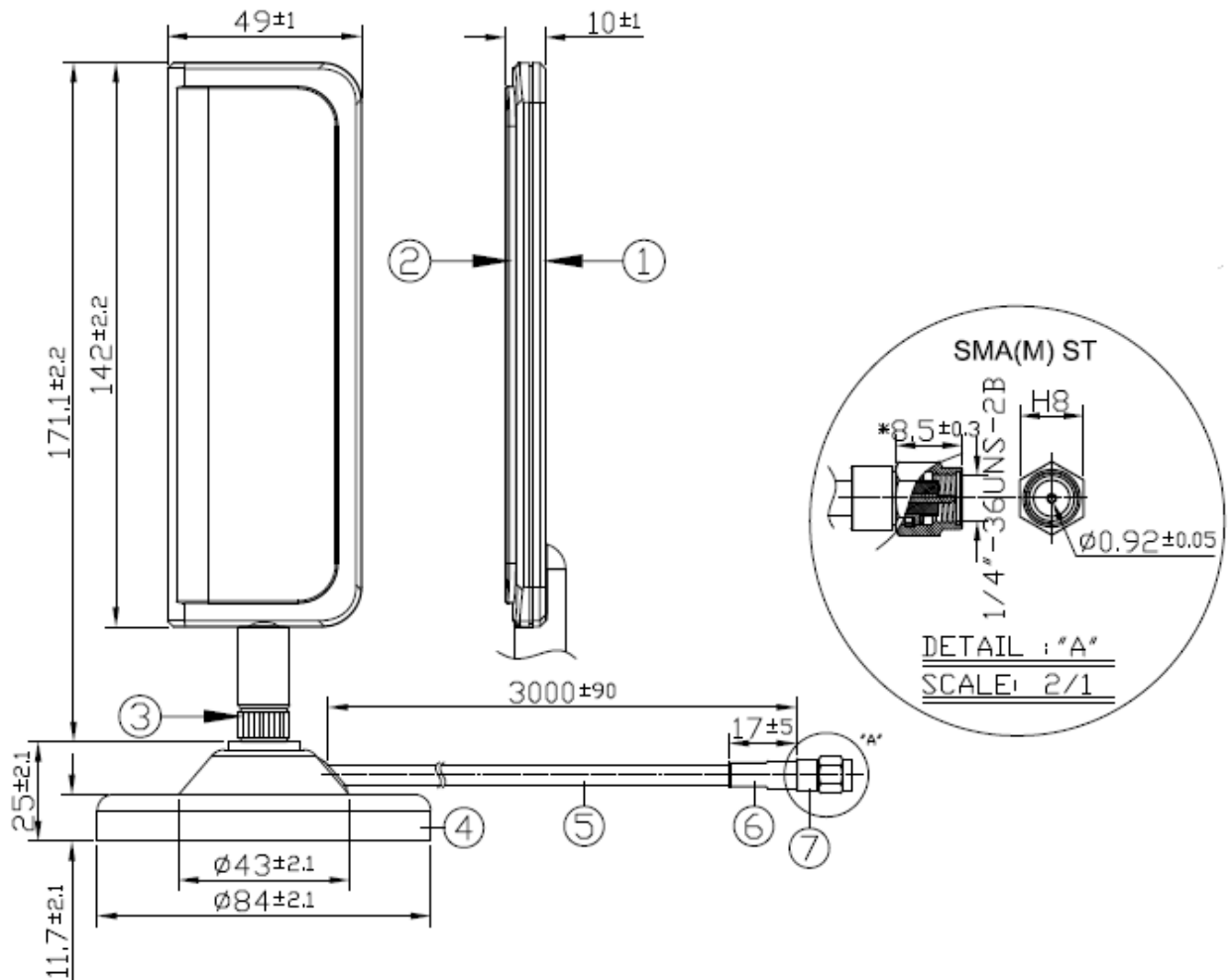

	Name	Material	Finish	QTY
1	Housing_Bottom_ST_B	ABS	Black	1
2	Housing_Top_B	ABS	Black	1
3	SMA(M) ST	Brass	Black	1
4	SMA(F) Magnet Mount	Steel	Black	1
5	CFD200 Coaxial Cable	PVC	Black	1
6	Heat Shrink Tube	PE	Black	1
7	SMA(M) ST	Brass	Gold	1

6. Packaging

6.1 Antenna Main Body

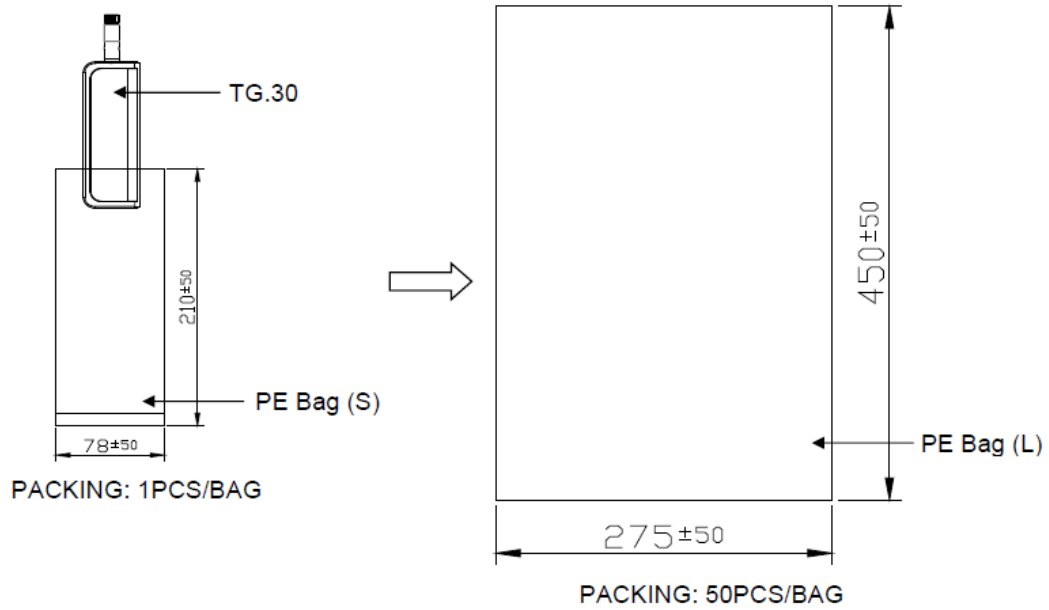

6.2 Magnetic Mounted Base

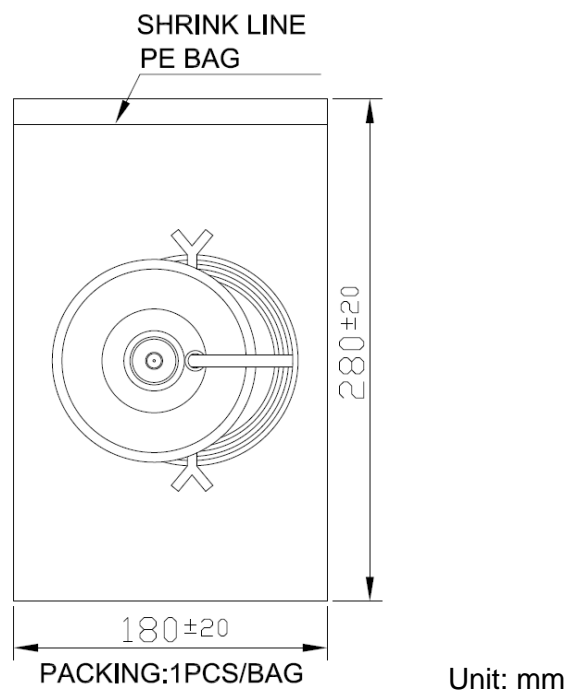

7. Magnetic Pull Force

7.1 Testing setup



Distance(mm)	0.5	1.0	1.5	2.0	2.5	2.8	3.5	4.0	4.5	5.0
Pulling force(Kgf)	0.86	1.37	1.86	2.32	2.75	2.92	2.73	2.65	2.58	2.52
Distance(mm)	5.5	6.0	6.5	7.0	7.5	8.0	8.5	9.0	9.5	10.0
Pulling force(Kgf)	2.49	2.46	2.44	2.42	2.42	2.42	2.42	2.41	2.41	2.42

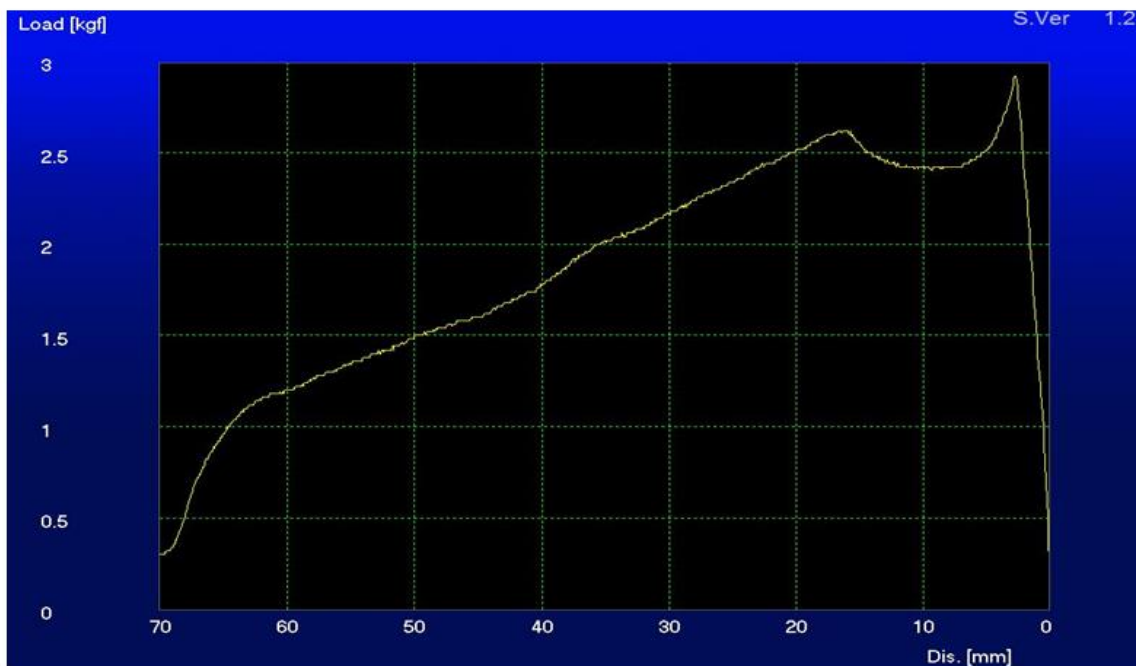

Maximum Pull Force : 2.92Kgf



Taoglas makes no warranties based on the accuracy or completeness of the contents of this document and reserves the right to make changes to specifications and product descriptions at any time without notice. Taoglas reserves all rights to this document and the information contained herein.

Reproduction, use or disclosure to third parties without express permission is strictly prohibited.

Copyright © Taoglas Ltd.