

**Power Relay F7**

- Pin assignment similar to ISO 7588 part 1
- Customized versions on request
  - 24VDC versions with contact gap >0.8mm
  - Integrated components (e.g. resistor, diode)
  - Customized marking/color
  - Special covers (e.g. notches, release features, brackets)

**Typical applications**

Cross carline up to 70A for example: ABS control, cooling fan, energy management, engine control, glow plug, heated front screen, ignition, lamps: front, rear, fog light, main switch/supply relay.

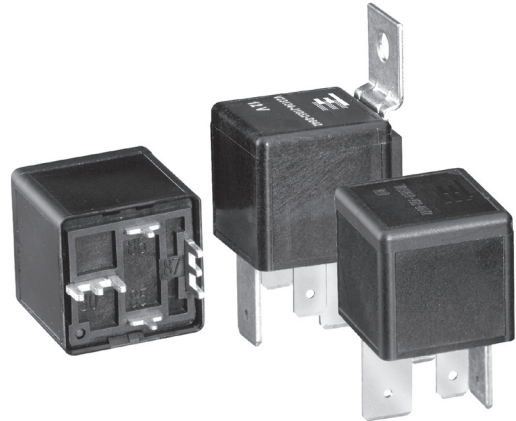

F134J\_a\_bw

**Contact Data**

|  |                                |   |                                |
|--|--------------------------------|---|--------------------------------|
| Contact arrangement  | 1 form A, 1 NO                 | 1 form A, 1 NO  | 1 form A, 1 NO                 |
| Contact gap  | -                              | -   | >0.8mm                         |
| Rated voltage  | 12VDC                          | 24VDC   | 24VDC <sup>1)</sup>            |
| Limiting continuous current  |                                |   |                                |
| 23°C   | 70A                            | 70A   | 70A                            |
| 85°C   | 50A                            | 50A   | 50A                            |
| 125°C  | 30A                            | 30A   | 30A                            |
| Limiting making current <sup>2)</sup>                                  | 240A                           | 240A  | 240A                           |
| Limiting breaking current  | 70A                            | 25A   | 40A                            |
| Limiting short-time current overload current, ISO 8820-3 <sup>3)</sup> |                                | 1.35 x 50A, 1800s<br>2.00 x 50A, 5s<br>3.50 x 50A, 0.5s<br>6.00 x 50A, 0.2s |                                |
| Jump start test, ISO 16750-1   |                                | 24VDC for 5min, conducting nominal current at 23°C                          |                                |
| Contact material   |                                | Silver based  |                                |
| Min. recommended contact load <sup>4)</sup>                            |                                | 1A at 5VDC  |                                |
| Initial voltage drop, form A (NO) contact at 10A, typ./max.            |                                | 10/300mV  |                                |
| Frequency of operation at nominal load                                 |                                | 6 ops./min (0.1Hz)  |                                |
| Operate/release time typ.  |                                | 7/2ms <sup>5)</sup>   |                                |
| Electrical endurance   |                                |   |                                |
| resistive load at 14VDC  | >1x10 <sup>5</sup> ops.<br>70A | -   | -                              |
| resistive load at 28VDC  | >2x10 <sup>5</sup> ops.<br>50A | -   | -                              |
| resistive load at 28VDC  | -                              | >1x10 <sup>5</sup> ops.<br>25A  | >1x10 <sup>5</sup> ops.<br>50A |

**Contact Data (continued)**

|   |                         |
|---|-------------------------|
| Mechanical endurance  | >1x10 <sup>7</sup> ops. |
| 1) Special high performance 24VDC version with contact gap >0.8mm, part number V23134-A0056-X408 (see part number table).   |                         |
| 2) The values apply to a resistive or inductive load with suitable spark suppression and at maximum 14VDC for 12VDC or 28VDC for 24VDC load voltages. For a load current duration of maximum 3s for a make/break ratio of 1:10. |                         |
| 3) Current and time are compatible with circuit protection by a typical automotive fuse. Relay will make, carry and break the specified current.  |                         |
| 4) See chapter Diagnostics of Relays in our Application Notes or consult the internet at <a href="http://relays.te.com/appnotes/">http://relays.te.com/appnotes/</a>  |                         |
| 5) For unsuppressed relay coil. A low resistive suppression device in parallel to the relay coil increases the release time and reduces the lifetime caused by increased erosion and/or higher risk of contact tack welding.    |                         |

**Coil Data**

|                    |              |
|--------------------|--------------|
| Rated coil voltage | 12VDC, 24VDC |
|--------------------|--------------|

**Coil versions, DC coil**

| Coil code | Rated voltage VDC | Operate voltage VDC | Release voltage VDC | Coil resistance <sup>6)</sup> Ω±10% | Rated coil power <sup>6)</sup> W |
|-----------|-------------------|---------------------|---------------------|-------------------------------------|----------------------------------|
| 052       | 12                | 7.2                 | 1.6                 | 90                                  | 1.6                              |
| 053       | 24                | 14.4                | 3.2                 | 324                                 | 1.8                              |
| 056       | 24                | 16.0                | 4.0                 | 268                                 | 2.1                              |
| 065       | 24                | 14.4                | 2.4                 | 288                                 | 2.0                              |

6) Without components in parallel.

All figures are given for coil without pre-energization, at ambient temperature +23°C.

**Max. DC load breaking capacity**

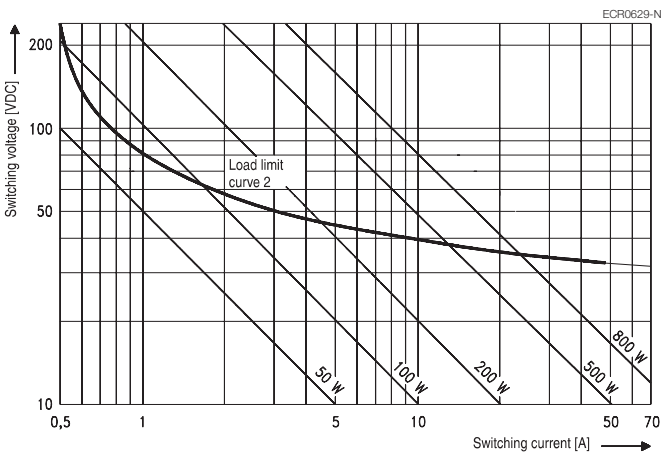

Load limit curve: safe shutdown, no stationary arc/make contact.  
Load limit curve measured with low inductive resistors verified for 1000 switching events.

**Coil operating range**

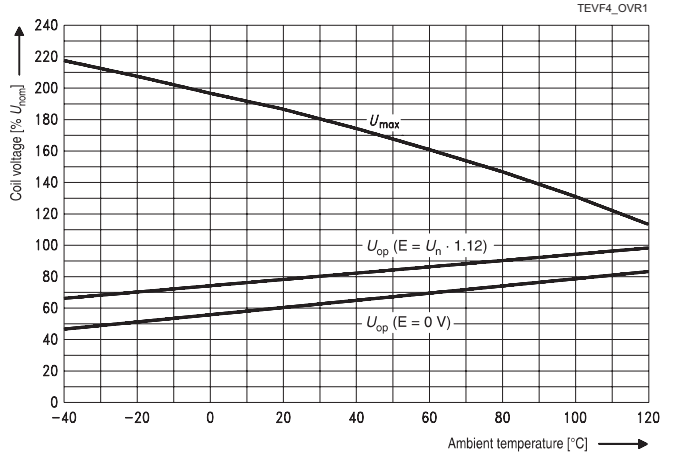

Does not take into account the temperature rise due to the contact current  
E = pre-energization.

**Power Relay F7** (Continued)

**Insulation Data**

|                                  |                          |
|----------------------------------|--------------------------|
| Initial dielectric strength      |                          |
| between open contacts            | 500V <sub>rms</sub>      |
| between contact and coil         | 500V <sub>rms</sub>      |
| between adjacent contacts        | 500V <sub>rms</sub>      |
| Load dump test                   |                          |
| ISO 7637-1 (12VDC), test pulse 5 | V <sub>s</sub> =+86.5VDC |
| ISO 7637-2 (24VDC), test pulse 5 | V <sub>s</sub> =+200VDC  |

**Other Data**

|   |  |
|---|--|
| EU RoHS/ELV compliance  | compliant  |
| Protection to heat and fire according UL-94                     | HB or better <sup>7)</sup>                                     |
| Ambient temperature   | -40 to 125°C   |
| Climatic cycling with condensation<br>EN ISO 6988               | 6 cycles, storage 8/16h  |
| Temperature cycling,<br>IEC 60068-2-14, Nb                      | 10 cycles, -40/+85°C (5°C/min)                                 |
| Damp heat cyclic,<br>IEC 60068-2-30, Db, Variant 1              | 6 cycles, upper air temp. 55°C                                 |
| Damp heat constant, IEC 60068-2-3, Ca                           | 56 days  |
| Category of environmental protection,<br>IEC 61810              | RT1 – dustproof, RT III – sealed                               |
| Degree of protection, IEC 60529                                 | IP54 (dustproof), IP67 (sealed)                                |
| Corrosive gas   |  |
| IEC 60068-2-42  | 10±2cm <sup>3</sup> /m <sup>3</sup> SO <sub>2</sub> , 10 days  |
| IEC 60068-2-43  | 1±0.3cm <sup>3</sup> /m <sup>3</sup> H <sub>2</sub> S, 10 days |
| Vibration resistance (functional)<br>IEC 60068-2-6 (sine sweep) | 10 to 500Hz, min. 5g <sup>8)</sup>                             |
| Shock resistance (functional)<br>IEC 60068-2-27 (half sine)     | 6ms, min. 30g <sup>8)</sup>                                    |
| Drop test, free fall<br>IEC 60068-2-32                          | 1m onto concrete   |

**Other Data** (continued)

|  |                     |
|--|---------------------|
| Terminal type                                      | plug-in, QC/ PCB    |
| Cover retention                                    |                     |
| axial force  | 150N                |
| pull force   | 150N                |
| push force   | 150N                |
| Terminal retention                                 |                     |
| pull force   | 100N                |
| push force   | 100N                |
| resistance to bending                              | 10N <sup>8)</sup>   |
| force applied to side                              | 10N <sup>8)</sup>   |
| torque   | 0.3Nm               |
| Weight   | approx. 38g (1.3oz) |
| Resistance to soldering heat THT<br>IEC 60068-2-20 | 260°C, 10s          |
| Packaging unit                                     |                     |
| plug-in:   | 210 pcs.            |
| plug-in with bracket:                              | 208 pcs.            |
| PCB  | 315 pcs.            |

7) Refers to used materials.

8) No change in the switching state >1µs. Valid for NC contacts, NO contact values significantly higher.

8) Values apply 2mm from the end of the terminal. When the force is removed, the terminal must not have moved by more than 0.3mm.

**Accessories**

For details see datasheet Connectors for Maxi ISO Relays

**Terminal Assignment**

NO  
1 form A, NO

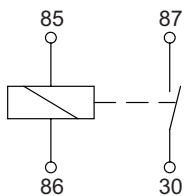

NOR  
1 form A, NO with resistor

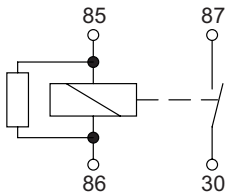

NOD  
1 form A, NO with diode

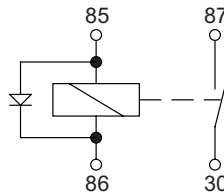

**Power Relay F7 (Continued)**

**Dimensions**

Power Relay F7 with quick connect terminals

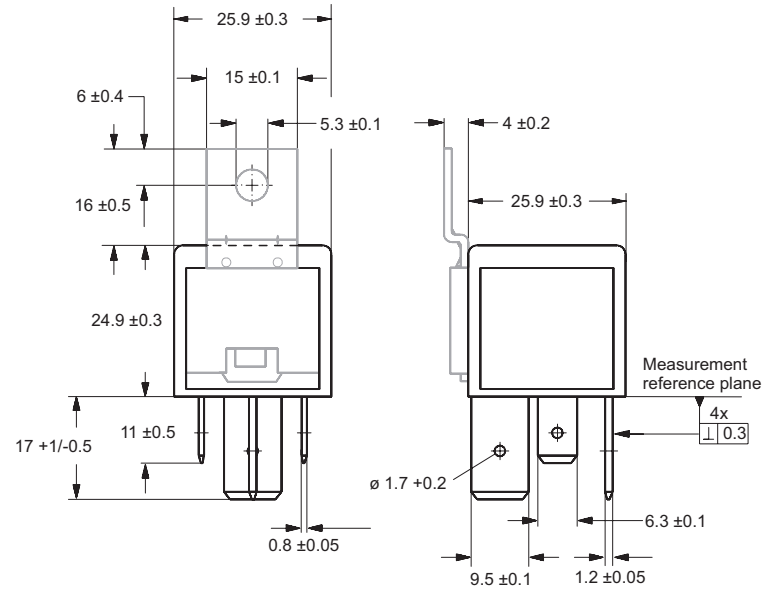

Quick connect terminal similar to ISO 8092-1

TE1098-Y1

View of the terminals (bottom view)

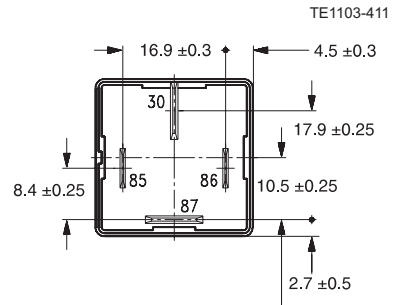

TE1103-411

Power Relay F7 with PCB terminals

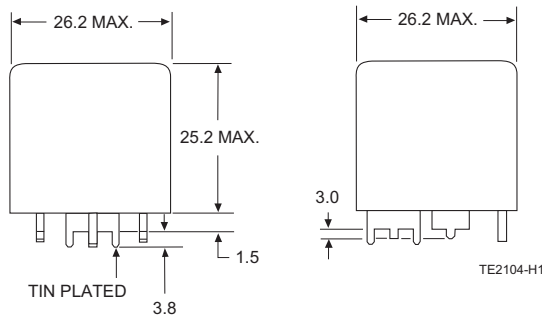

View of the terminals (bottom view)

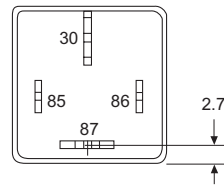

TE2104-H1

**PCB Layout**

Bottom view on solder pins

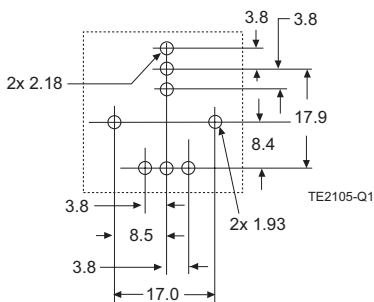

TE2105-Q1

## Power Relay F7 (Continued)

### Product code structure

Typical product code **V23134 -J 0 052 -D642**

|  |  |
|--|--|
| <b>Type</b><br>V23134 Power Relay F  |  |
| <b>Contact arrangement</b><br>J 1 form A, 1 NO                                       |  |
| <b>Cover</b><br>0 Standard 1 Bracket near terminal 30 ISO                            |  |
| <b>Coil</b><br>052 12VDC 053 24VDC<br>056 24VDC (contact gap >0.8mm) 065 24VDC       |  |
| <b>Terminal/arrangement</b><br>D642 Plug-in/NO Xnnn Customized (nnn: version number) |  |

| Product code                    | Arrangement    | Cover    | Coil suppr.        | Circuit <sup>1)</sup> | Coil  | Cont. material | Terminals                 | Part number |
|---------------------------------|----------------|----------|--------------------|-----------------------|-------|----------------|---------------------------|-------------|
| V23134-J0052-D642               | 1 form A, 1 NO | Standard |                    | NO                    | 12VDC | Silver based   | Plug-in, QC               | 7-1393303-3 |
| V23134-J0052-X429               |                |          | Resistor 680Ω      | NOR                   |       |                |                           | 1-1414147-0 |
| V23134-J0052-X439               |                |          | Diode (cathode 86) | NOD                   |       |                |                           | 1-1414286-0 |
| V23134-J0052-X455               |                |          | Resistor 470Ω      | NOR                   |       |                | PCB                       | 1-1414610-0 |
| V23134-J0052-X511               |                |          |                    | NO                    |       |                |                           | 3-1415001-2 |
| V23134-J0052-X461               |                |          | Resistor 560Ω      | NOR                   |       |                | Plug-in, QC <sup>3)</sup> | 1-1414469-0 |
| V23134-J0053-D642               |                |          |                    | NO                    | 24VDC |                | Plug-in, QC               | 9-1393303-7 |
| V23134-J0056-X408 <sup>2)</sup> |                |          | Resistor 1200Ω     | NOR                   |       |                | Plug-in, QC <sup>3)</sup> | 0-1393304-5 |
| V23134-J0065-X497 <sup>4)</sup> |                |          |                    | NO                    |       |                | PCB                       | 3-1414937-3 |
| V23134-J1052-D642               |                | Bracket  |                    |                       | 12VDC |                | Plug-in, QC               | 0-1393304-9 |
| V23134-J1052-X281               |                |          | Resistor 560Ω      | NOR                   |       |                |                           | 1-1393304-0 |
| V23134-J1053-D642               |                |          |                    | NO                    | 24VDC |                |                           | 1-1393304-1 |

1) See terminal assignment diagrams.

2) Special feature: contact gap >0.8mm.

3) Special feature: 14.5mm load terminals.

4) Packed in tray with 300 pcs. per unit.

Other types on request.

This list represents the most common types and does not show all variants covered by this datasheet.