

# Rectangular Style Analog Panel Meters

- UL Recognized - File # E91015  
Except for the Wattmeters & Frequency Meters
- Plastic case with Glass Window
- Calibration not affected when mounted on steel
- Three popular sizes:  
2-1/2", 3-1/2", 4-1/2"



For Specifications and Dimensions see the last pages

## Ordering Information

Frequency, Self-Shielding Movement		Not 		
Range	Voltage	Model / Size and Catalog Number		
		2-1/2" Model 187	3-1/2" Model 87	4-1/2" Model 89
45-55 Hz	120V	35136	35142	35148
55-65 Hz	120V	35138	35144	35150
380-420 Hz	120V	35140	35146	35152
45-55 Hz	240V	35137	35143	35149
55-65 Hz	240V	35139	35145	35151
380-420 Hz	240V	35141	35147	35153



# Rectangular Style Analog Panel Meters

## Ordering Information

4-20 mA Process Meters, Dial Indicates 0-100%				
Size	Style	Model	Approx. Impedance (Ohms)	Catalog No.
3-1/2"	Rectangular	27	5.0	35023
4-1/2"	Rectangular	29	5.0	35024

Wattmeters, Self Shielding Movement			Not 		
Range	Maximum		Model / Size and Catalog Number		
	Volts	Amps	2-1/2" Model 177	3-1/2" Model 77	4-1/2" Model 79
0-20	150	.400	< >	< >	10714
0-75	150	1.0	10860	10650	10720
0-150	150	2.0	< >	< >	10730
0-300	150	4.0	< >	< >	10740
0-600	300	4.0	< >	10680	10750
0-750	150	10.0	10900	10690	10760
0-1500	300	10.0	10910	10700	10770
0-3000	300	20.0	10920	10710	10780

< > Available on special order

## Ordering Information

<b>DC Voltmeters, Self-Shielding Movement</b>				
Range	Approx. Impedance (Ohms) @ 60 Hz	Model / Size and Catalog Number		
		2-1/2" Model 127	3-1/2" Model 27	4-1/2" Model 29
0-1.5	1000 Ohms per Volt	09020	07290	07620
0-3		09030	07300	07630
0-5		09040	07310	07640
0-8		09050	< >	07650
0-10		09060	07330	07660
0-15		09080	07350	07670
0-25		09090	07360	07680
0-30		09100	07370	07690
0-50		09110	07380	07700
0-100		09130	07400	07710
0-150		09140	07410	07720
0-200		09160	07430	07730
0-250		09170	07440	07740
0-300		09180	07450	07750
0-500		2000 Ohms per Volt	09200	07470
0-750	< >		07490	07770
0-1000	< >		07495 *	07780 *
0-1500	< >		07520 *	07790 *
0-2000	09225 *		07530 *	07800 *
0-2500	< >		07550 *	07810 *
0-3000	< >		07560 *	07820 *
0-4000	< >		< >	07830 *
0-5000	< >		07600 *	07840 *
< > Available on special order				
* External multipliers (Model 183) are furnished on 2-1/2" DC meters 750 volts or higher and on 3-1/2" and 4-1/2" DC Meters 1000 volts or higher				



# Rectangular Style Analog Panel Meters

## Ordering Information

<b>DC Millivoltmeters, Self-Shielding Movement</b>				
Range	Approx. Impedance (Ohms) @ 60 Hz	Model / Size and Catalog Number		
		2-1/2" Model 127	3-1/2" Model 27	4-1/2" Model 29
0-50	10.0	06990	06930	06950
0-100	20.0	< >	06940	06960
< > Available on special order				

<b>DC Taut-Band Microammeters, Self-Shielding Movement</b>				
Range	Approx. Impedance (Ohms) @ 60 Hz	Model / Size and Catalog Number		
		2-1/2" Model 127T	3-1/2" Model 27T	4-1/2" Model 29T
0-10	4900	04246	03839	03939
0-15	1960	04248	03841	03941
0-25	1960	04251	03851	03951
0-50	960	04261	03961	03961
0-100	500	< >	03871	03971
< > Available on special order				



# Rectangular Style Analog Panel Meters

## Ordering Information

<b>DC Microammeters, Self-Shielding Movement</b>				
Range	Approx. Impedance (Ohms) @ 60 Hz	Model / Size and Catalog Number		
		2-1/2" Model 127	3-1/2" Model 27	4-1/2" Model 29
0-50	1800	04260	03860	03960
0-100	1800	04270	03870	03970
0-200	1100	04280	03880	03980
0-500	90	< >	03890	03990
25-0-25	1800	04243	03900	04000
50-0-50	1800	04245	03910	04010
100-0-100	1100	04247	03920	04020
500-0-500	43	< >	03930	04030

< > Available on special order

<b>DC Milliammeters, Self-Shielding Movement</b>				
Range	Approx. Impedance (Ohms) @ 60 Hz	Model / Size and Catalog Number		
		2-1/2" Model 127	3-1/2" Model 27	4-1/2" Model 29
0-1	43.0	05760	04790	05070
0-1.5	43.0	< >	04810	05080
0-3	2.0	05790	04820	05090
0-5	2.0	05800	04830	05100
0-10	10.0	05810	04840	05110
0-15	6.6	05830	04860	05120
0-20	5.0	< >	04880	05130
0-25	4.0	05860	04890	05140
0-50	2.0	05880	04910	05150
0-75	1.3	< >	< >	< >
0-100	1.0	05910	04940	05170
0-150	.66	05930	04960	05180
0-200	.5	05940	04980	05190
0-250	.4	< >	05000	05200
0-300	.33	< >	05010	05210
0-500	.2	05990	05030	05220
0-750	.13	< >	05050	05230
0-1000	.05	06020	05060	05240

< > Available on special order



# Rectangular Style Analog Panel Meters

## Ordering Information

<b>DC Ammeters, Self-Shielding Movement</b>				
Range	Approx. Impedance (Ohms) @ 60 Hz	Model / Size and Catalog Number		
		2-1/2" Model 127	3-1/2" Model 27	4-1/2" Model 29
0-1	.050	01680	00230	00450
0-1.5	.033	01690	00240	00460
0-2	.025	01709	00250	00470
0-3	.0166	01710	00260	00480
0-5	.010	01720	00270	00490
0-10	.005	01730	00280	00500
0-15	.0033	01740	00290	00512
0-25	.0020	01750	00300	00520
0-30	.0017	01760	00310	00530
0-50	.001	01770	00320	00540
0-75	10.0	01780 †	00330 †	00550 †
0-100	10.0	01790 †	00340 †	00560 †
0-150	10.0	01800 †	00350 †	00570 †
0-200	10.0	01810 †	< >	00580 †
0-250	10.0	< >	< >	00590 †
0-300	10.0	< >	00380 †	00600 †
0-500	10.0	< >	00390 †	00610 †
0-750	10.0	< >	00400 †	00620 †
0-1000	10.0	< >	00410 †	00630 †
15-0-15	.0033	< >	< >	00640
30-0-30	.0017	01880	00430	00650
50-0-50	.001	01890	00440	00660
<b>&lt; &gt; Available on special order</b>				
† DC current meters are self-contained for ranges up to and including 50 amperes.				
Higher range DC current meters (50 mV) listed above are calibrated for 5' leads and require external shunts.				



# Rectangular Style Analog Panel Meters

## Ordering Information

<b>AC Microammeters Rectifier Type, Self-Shielding Movement</b>				
Range	Approx. Impedance (Ohms) @ 60 Hz	Model / Size and Catalog Number		
		2-1/2" Model 147	3-1/2" Model 47	4-1/2" Model 49
0-100	3400	< >	04120	04160
0-200	2400	< >	< >	04170
0-300	1800	< >	04140	04180
0-500	1200	< >	04150	04190
< > Available on special order				

<b>AC Milliammeters, Iron Vane Movement</b>				
Range	Approx. Impedance (Ohms) @ 60 Hz	Model / Size and Catalog Number		
		2-1/2" Model 157	3-1/2" Model 57	4-1/2" Model 59
0-10	650.0	< >	05440	05510
0-15	887.0	< >	05499	< >
0-25	270.0	< >	05460	05530
0-50	80.0	06130	05470	05540
0-100	17.2	06140	05480	05550
0-250	3.1	06150	05490	05560
0-500	.9	06152	05500	05570
< > Available on special order				



# Rectangular Style Analog Panel Meters

## Ordering Information

<b>AC Milliammeters Rectifier Type, Self Shielding Movement</b>				
Range	Approx. Impedance (Ohms) @ 60 Hz	Model / Size and Catalog Number		
		2-1/2" Model 147	3-1/2" Model 47	4-1/2" Model 49
0-1	600	< >	06850	06880
0-2	400	< >	06860	06890
0-5	200	< >	06870	06900
< > Available on special order				

<b>AC Ammeters, Iron Vane Movement</b>				
Range	Approx. Impedance (Ohms) @ 60 Hz	Model / Size and Catalog Number		
		2-1/2" Model 157	3-1/2" Model 57	4-1/2" Model 59
0-1	.213	02270	01120	01290
0-1.5	.105	< >	01130	01302
0-2	.065	02290	01140	01310
0-3	.028	02300	01145	01320
0-5	.008	02310	01160	01330
0-10	.004	02320	01170	01340
0-15	.0025	02330	01180	01350
0-25	.002	02340	01190	01360
0-30	.0015	02350	01200	01370
0-50	.001	02360	01210	01380
0-75	.0002	< >	03434	03436
0-75	.008	02370 †	< >	< >
0-100	.008	02380 †	01230 †	01400 †
0-150	.008	02390 †	01240 †	01410 †
0-200	.008	< >	01250 †	01420 †
0-250	.008	02410 †	01260 †	01430 †
0-300	.008	02420 †	01270 †	01440 †
0-500	.008	02422 †	01280 †	01450 †
< > Available on special order				
† These meters are 5 amp meters with scales as indicated and require external donut transformers				





# Rectangular Style Analog Panel Meters

## Ordering Information

AC Voltmeters Rectifier Type, Self Shielding Movement				
Range	Approx. Impedance (Ohms) @ 60 Hz	Model / Size and Catalog Number		
		2-1/2" Model 147	3-1/2" Model 47	4-1/2" Model 49
0-1	2000 Ohms per Volt	< >	08120	08300
0-3		< >	08130	08310
0-5		< >	< >	08320
0-10		< >	< >	08330
0-15		< >	< >	08340
0-50		< >	< >	08350
0-100		< >	08180	08360
0-150		< >	08190	08370
0-300		< >	< >	08371

< > Available on special order

AC Voltmeters, Iron Vane Movement				
Range	Approx. Impedance (Ohms) @ 60 Hz	Model / Size and Catalog Number		
		2-1/2" Model 157	3-1/2" Model 57	4-1/2" Model 59
0-1.5	3	< >	< >	08710
0-3	12	< >	08540	08720
0-5	33	09390	08550	08730
0-10	133	09400	08566	08740
0-15	300	09420	08580	08750
0-25	833	09440	08599	08760
0-50	3,333	09450	08610	08770
0-100	16,166	09460	08620	08780
0-150	25,000	09470	08630	08790
0-250	41,166	09490	08650	08800
0-300	50,000	09500	08660	08810
0-500	83,333	09520 †	08680 †	08820 †
0-750	125,000	< >	08690 †	08830 †
0-1000	166,666	< >	08700 †	08840 †

† External multipliers, Model 183 are furnished on AC meters having a range of 500 volts or higher. All others have self contained multipliers.

< > Available on special order

# Rectangular Style Analog Panel Meters

<b>Specifications</b>	
<b>Accuracy</b>	±2% full scale (iron-vane), ±3% (rectifier)
<b>Wattmeters:</b>	±2% full scale; Compensated meters: ±3% full scale
<b>Movement</b>	Model 57, 59, 157 Iron-vane, magnetically damped Wattmeters: Dynamometer All others: Annular, rectifier type, self-shielding
<b>Suspension</b>	Pivot and jewel; "T" styles: taut band
<b>Tracking</b>	±3%
<b>Shielding</b>	Calibration is unaffected by magnetic panel mounting
<b>Response Time</b>	1.5 seconds maximum
<b>Overload (1 sec.)</b>	10 times F.S.
<b>Overload (Continuous)</b>	1.5 times F.S.
<b>Repeatability</b>	2 %, tautband: .5%
<b>Dial</b>	Sharp clear scale. Each dial arc is calibrated to track the specific type of movement used
<b>Resistance</b>	±15% of meter impedance
<b>Pointer</b>	Spade pointer with black, matte finish
<b>Scale Length</b>	Models 177 & 157: 1.6" (40.6mm) Models 147, 127 & 127T: 1.8" (45.7mm) Models 57 & 77: 2.3" (58.4mm) Models 27, 27T & 47: 2.5" (63.5mm) Models 59 & 79: 3.50" (89.0mm) Models 29, 29T & 49: 3.9" (99.0mm)
<b>Net Weight</b>	Models 57 & 157: 5 oz. (0.14 kg) Model 127, 127T & 147: 7 oz. (0.20 kg) Models 27, 27T, 47 & 59: 8 oz. (0.23 kg) Models 77 & 177: 9 oz. (0.26 kg) Models 29, 29T & 49: 11 oz. (0.31 kg) Model 79: 12 oz. (0.34 kg)

# Rectangular Style Analog Panel Meters

<b>Frequency Meter Specifications</b>	
<b>Accuracy</b>	45-55 Hz $\pm$ 0.3 Hz (120V-240V)
	55-65 Hz $\pm$ 0.3 Hz (120V-240V)
	380-420 Hz $\pm$ 1.2 Hz (120V-240V)
<b>Movement</b>	Small core magnet, self-shielding
<b>Suspension</b>	Pivot and jewel
<b>Shielding</b>	Calibration is unaffected by magnetic panel mounting
<b>Center Scale Value</b>	50/60/400 Hz
<b>Power Consumption</b>	1.6 VA
<b>Warm-up Time</b>	5 minutes
<b>Max. Input: Voltage (10 sec)</b>	150, 120V normal
	280, 240V normal
<b>Dial</b>	Sharp clear scale. Each dial arc is calibrated to track the specific type of movement used
<b>Case</b>	High density black plastic
<b>Operating Temperature</b>	-4°F to + 149°F (-20°C to + 65°C)
<b>Pointer</b>	Spade pointer with black, matte finish
<b>Scale Length</b>	Model 187: 1.8" (45.7mm)
	Model 89: 3.5" (89.0mm)
	Model 87: 3.9" (99.0mm)
<b>Net Weight</b>	Model 187: 5 oz. (0.14 kg)
	Model 87: 8 oz. (0.23 kg)
	Model 89: 11 oz. (0.31 kg)

# Rectangular Style Analog Panel Meters

## Dimensions

3-1/2" Model 27 & 27T, 47, 57, & 87

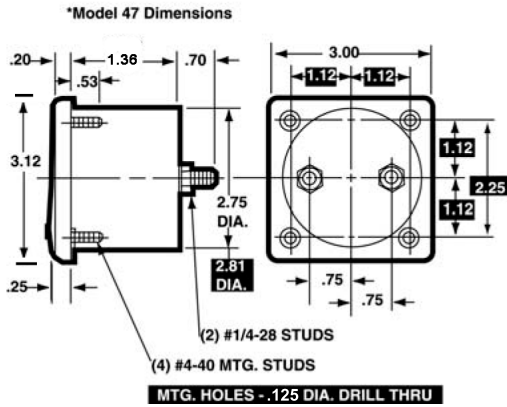

3-1/2" Model 77

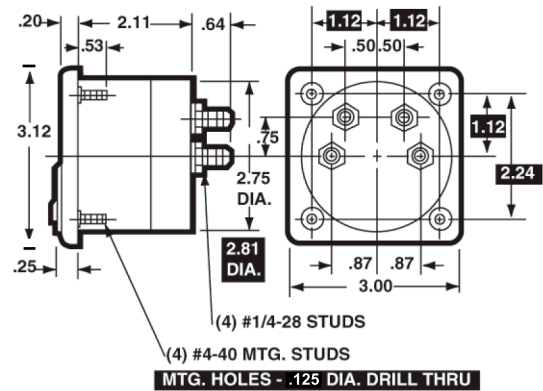

4-1/2" Model 29 & 29T, 49, 59, & 89

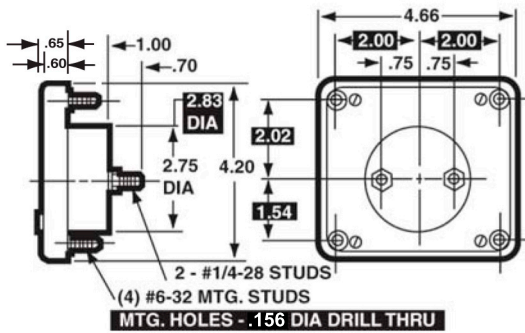

4-1/2" Model 79

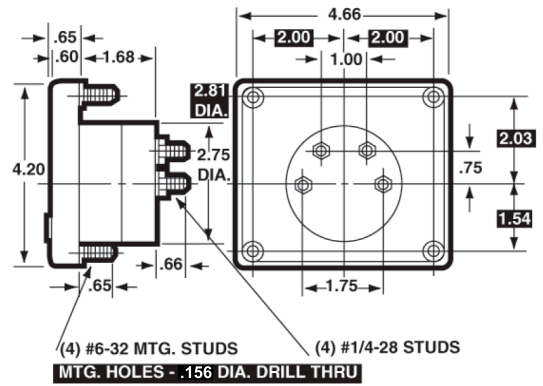

2-1/2" Model 177

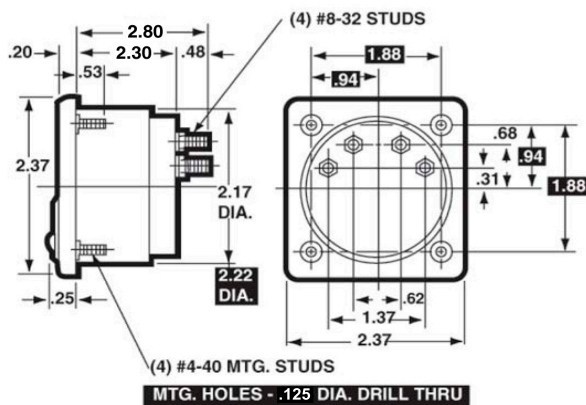

2-1/2" Model 127 & 127T, 147, 157, & 187

