

# SPECIFICATION

PROD. NAME	SMD Common Mode Filter	PART NO.		SRF4530A SERIES	
		REF.:	REV.I(20160309)	PAGE	1

## I . Configuration and dimensions :

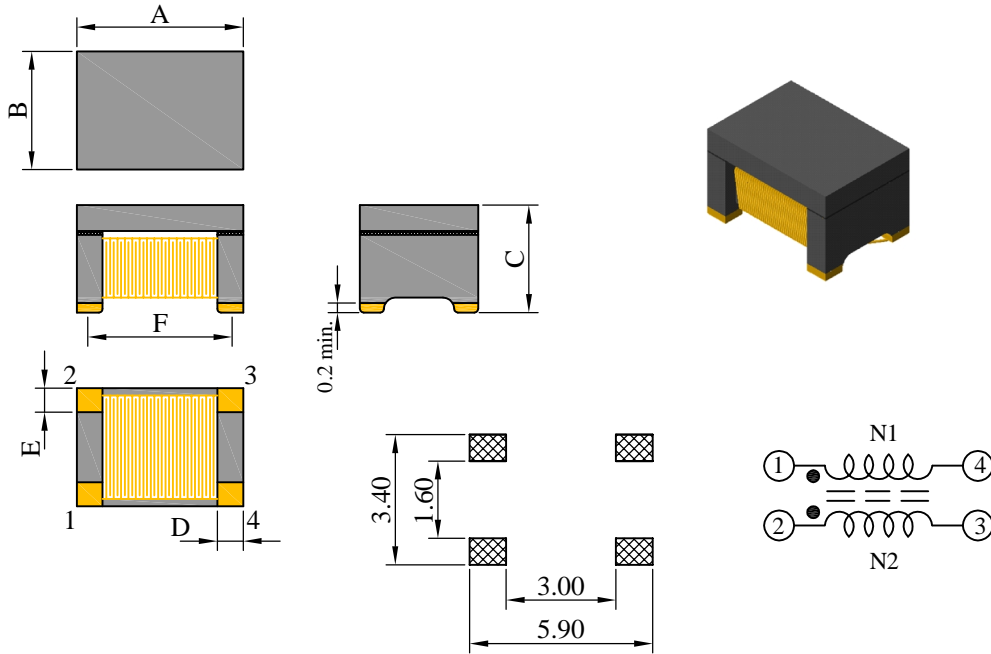

Unit : m/m

A	B	C	D	E	F
4.50 ±0.2	3.20 ±0.2	3.00 max.	0.70 ref.	0.65 ref.	3.80 ref.

## II . Description :

- a . Ferrite drum core construction.
- b . Magnetically shielded.
- c . Enamelled copper wire : H class
- d . Product weight : 0.15 g ( ref. )
- e . Moisture sensitivity Level 1
- f . Products comply with RoHS' requirements
- g . Halogen Free available

Peak Temp : 250°C max.  
Max. Peak Temp - 5°C : 30sec max.  
Max time above 217°C : 60sec~150sec max.

## III . General specification :

- a . Storage temp. : -55°C ----+150°C
- b . Operating temp. : -55°C ----+150°C  
(Temp. rise included)
- c . Resistance to solder heat : 250°C .10 secs.
- d . Qualification to AEC-Q200 , available for automotive application on driver assistant , entertainment & lighting system.

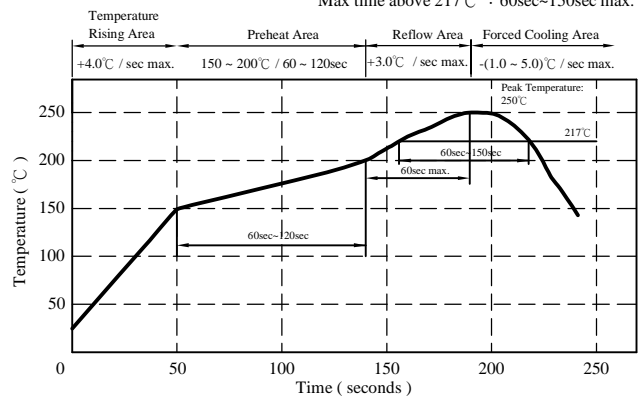

# BOURNS INDUCTIVE COMPONENTS

# SPECIFICATION

PROD. NAME	SMD Common Mode Filter	PART NO.	SRF4530A SERIES		
		REF.:	REV.I(20160309)	PAGE	2

## IV . Electrical characteristics :

PART NO.	Inductance ( $\mu$ H)	Lstray ( $\mu$ H) typ.	RDC ( $\Omega$ )	IDC ( A )	Common mode impedance ( k $\Omega$ )(@10MHz)	
			max.		min.	typ.
SRF4530A-110Y	11.0 <sup>+50%</sup> <sub>-30%</sub>	0.10	0.50	0.36	0.30	0.60
SRF4530A-220Y	22.0 <sup>+50%</sup> <sub>-30%</sub>	0.15	0.60	0.31	0.60	1.20
SRF4530A-510Y	51.0 <sup>+50%</sup> <sub>-30%</sub>	0.25	1.00	0.23	1.50	3.50
SRF4530A-101Y	100.0 <sup>+50%</sup> <sub>-30%</sub>	0.30	1.50	0.20	3.00	7.50

- 1). Electrical specifications at 25°C
- 2). Inductance Test Condition. : 100kHz / 0.1V
- 3). IDC base on Temp. rise 40°C max.
- 4). Insulation resistance : 10M $\Omega$  min.
- 5). Rated voltage : 50Vdc

# SPECIFICATION

PROD. NAME	SMD Common Mode Filter	PART NO.		SRF4530A SERIES	
		REF.:	REV.I(20160309)	PAGE	3

V . Curve :

**SRF4530A-110Y**

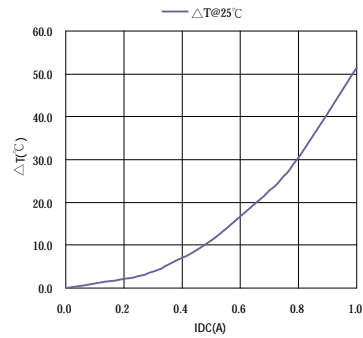
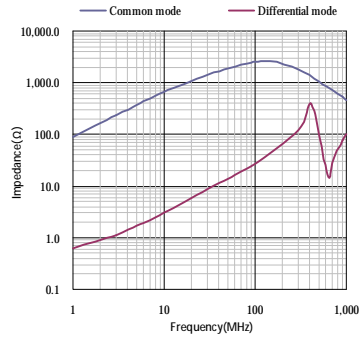

**SRF4530A-220Y**

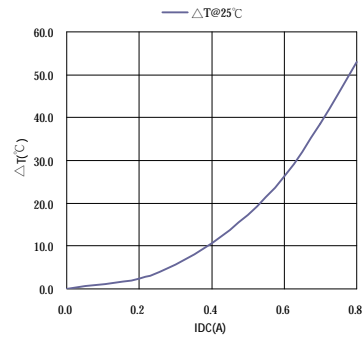
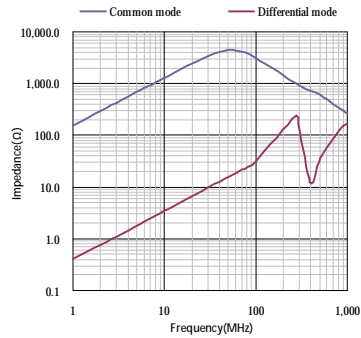

**SRF4530A-510Y**

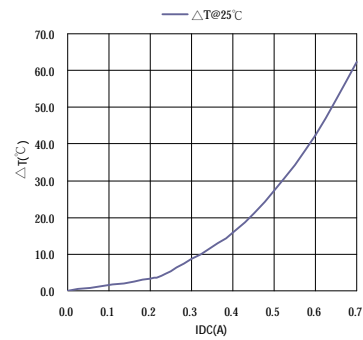
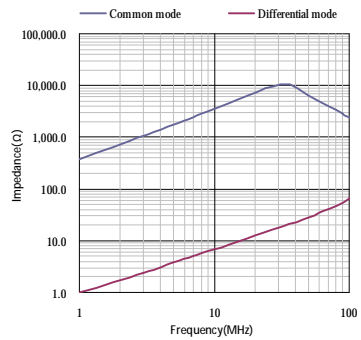

**SRF4530A-101Y**

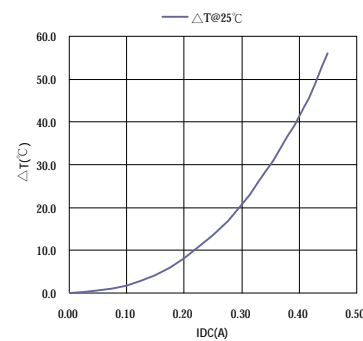
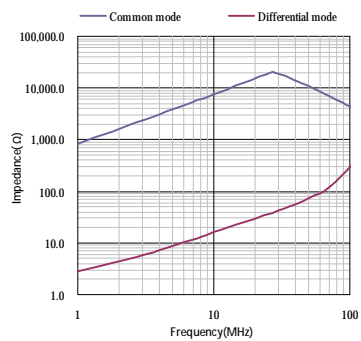

# SPECIFICATION

PROD. NAME	SMD Common Mode Filter	PART NO.		SRF4530A SERIES	
		REF.:	REV.I(20160309)	PAGE	4

## VI . Packaging information :

### ( 1 ) Configuration

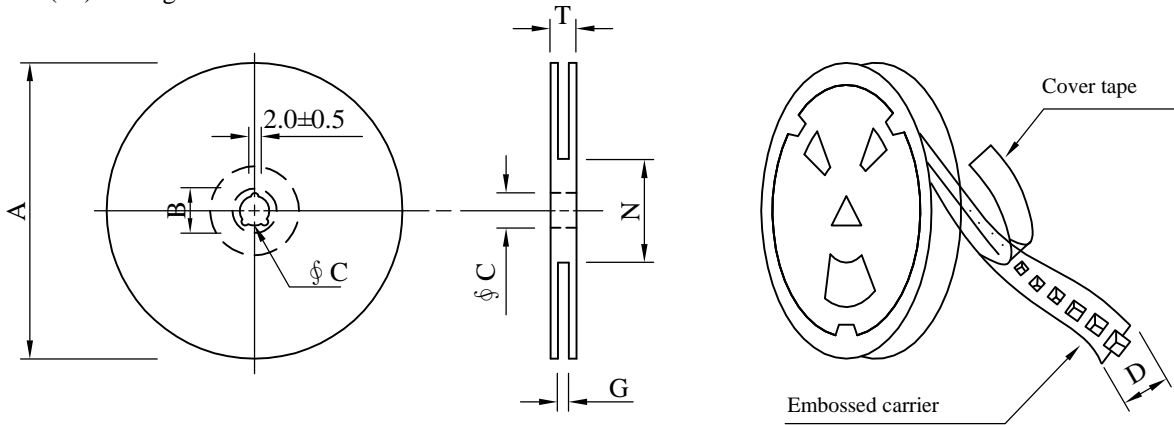

※Carrier tape width : D

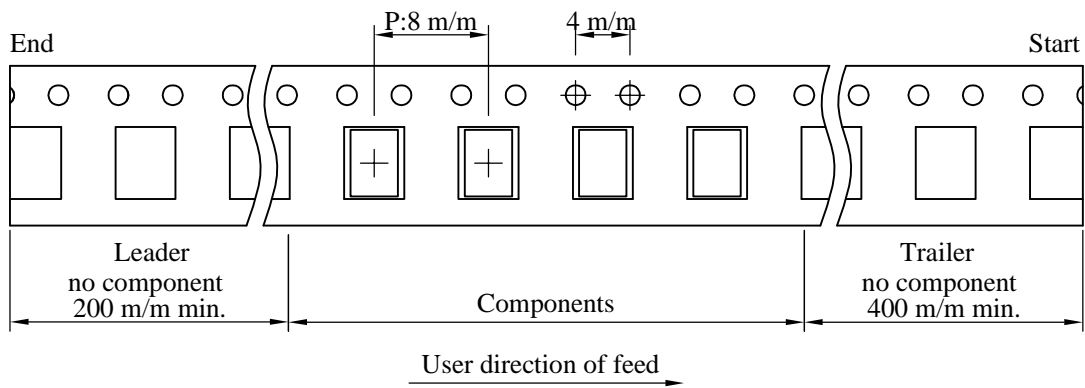

### ( 2 ) Dimensions

Unit:m/m

Style	A	B	C	D	G	N	T
07 - 12	178	21±0.8	13	12	14 <sup>+0</sup>	50 <sup>-0</sup>	16.5

### ( 3 ) Q'TY & G.W. Pe package

Inner : Reel			Outer : Carton		
Q'TY (pcs)	G.W. (gw)	Style	Q'TY (pcs)	G.W. (kg)	Size (cm)
500	120	07 - 12	20,000	4.80	41 x 39 x 22

## BOURNS INDUCTIVE COMPONENTS

# SPECIFICATION

PROD. NAME	SMD Common Mode Filter	PART NO.	SRF4530A SERIES		
		REF.:	REV.I(20160309)	PAGE	5

## VII . Reliability test :

Item	Reference documents	AEC-Q200 Test Condition	Specification
1.High Temperature Exposure	MIL-STD-202 Method 108	1.Temperature: 150°C 2.Time:1000 hours.	1.No mechanical or electrical damage. 2.Inductance shall not change more than ±50%.
2.Temperature Cycling	JESD22 Method JA-104	1.Temperature: -55°C ~ 150°C 2.Number of cycle:1000 cycle 3.Dwell time:30 minutes	1.No mechanical or electrical damage. 2.Inductance shall not change more than ±50%.
3.Biased Humidity Test	MIL-STD-202 Method 103	1.Temperature : 85±5 °C 2.Time:1000 Hours 3.Humidity : 85±5% RH.	1.No mechanical or electrical damage. 2.Inductance shall not change more than ±50%.
4.Operational Life	MIL-PRF-27-3.26/4.7.23 & User Spec.	1.Temperature:150°C (Temp. rise included) 2.Time:1000 hours. 3.Apply rated current.	1.No mechanical or electrical damage. 2.Inductance shall not change more than ±50%.
5.External Visual	MIL-STD-883 Method 2009	Inspect product constructions, marking and workmanship.	1.No pollution on the surface of products. 2.Clear marking. 3.No crack.
6.Physical Dimensions	JESD22 Method JB-100	Verify physical dimensions to the applicable product detail specification.	Per product specification standard
7.Resistance to solvents	MIL-STD-202 Method 215	Immerse into solvent for 3±0.5 minutes & brush 10 times for 3 cycles.	1.No body deformation change in appearance or obliteration of marking. 2.Inductance shall not change more than ±50%.
8.Mechanical Shock	MIL-STD-202 Method 213	1.Peak acceleration 100g`s 2.Duration of pulse: 6ms 3.Waveform : Half-sine 4.Velocity change: 12.3ft/sec 5.Direction : ±X, ±Y, ±Z (3times / axis )	1.No mechanical or electrical damage. 2.Inductance shall not change more than ±50%.
9.Vibration Test	MIL-STD-202 Method 204	1.Frequency and Amplitued :10-2000-10 Hz 2.Sweep time : 20 min 3.Acceleration : 5g 4.Direction : X , Y , Z 5.Number of sweep : 12 time/axis	1.No mechanical or electrical damage. 2.Inductance shall not change more than ±50%.
10.Resistance To Soldering Heat Test	MIL-STD-202 Method 210 & J-STD020D.1	1.Highest temperature : 250±5°C 2.Time ( temp. ≥ 217°C ) : 60~150 second. 3.IR reflow times : 3 times.	1.No mechanical or electrical damage. 2.Inductance shall not change more than ±50%.
11.ESD	AEC-Q200-002 or ISO/DIS 10605	1.ESD Voltage : 15KV 2.Mode 1 : 150 pF / 330 Ω 3.Mode 2 : 150 pF / 2000 Ω 4.Discharge times and polarity : 3 times pos. / 3 times eng. for each condition	1.No mechanical or electrical damage. 2.Inductance shall not change more than ±50%.
12.Solderability Test	J-STD-002	1.Baking in pre-testing : 150±5°C / 16Hours±30 min. 2.Peak temperature : 240±5 3.Time ( temp. ≥ 217°C ) : 60~150 second. 4.IR reflow times : 1 times.	More than 95% soldering coverage min on terminations.
13.Electrical Characteriazation	MIL-STD-202 Method 304 & User Spec.	1.Operating temperature : -55°C~150°C 2.Room temperature : 25°C.	1.No mechanical or electrical damage. 2.Inductance shall not change more than ±50%.
14.Flammability			
15.Board Flex	AEC-Q200-005	1.Deflection speed : 1 mm/ sec 2.Amount of deflection : 2 mm 3.Span : 90 mm 4.Direction for test : Bottom of PCB 5.Holding time : 60 sec	1.No mechanical or electrical damage. 2.Inductance shall not change more than ±50%.
16.Terminal Strength Test	AEC-Q200-006	1.Apply push force to samples mounted on PCB. 2.Force of 1.8 kg for 60±1 seconds.	After test, inductors shall be no mechanical damage.

**BOURNS INDUCTIVE COMPONENTS**