



PC, HDMI, DISPLAY PORT, SDI INTERFACE CONTROLLER FOR TFT PANEL

Model: ALR-1920-SDI

Part number : 41728001X-3 or up

INSTRUCTIONS

CONTENTS

Page:	2. Introduction, How to Proceed, Usage Note, Disclaimer
	3. System design – Diagram of a suggested system
	4. Assembly notes – Important information about system elements
	6. Connection & Operation – How to use the controller
	10. Connectors, pinouts & jumpers – Essential connection information
	19. Controller dimensions
	20. Application notes
	22. Troubleshooting
	23. Specifications
	24. Appendix I – Mode Support Table
	27. Appendix II – RS-232 control protocols
	30. Appendix III – Mapping definition
	32. Appendix IV – Auto Color Gain
	33. Appendix V – DV remote control unit work for ALR-1920-SDI
	34. Warranty, Caution & Limitation of Liability, Trademarks
	35. Contact details

It is essential that these instructions are read and understood before connecting or powering up this controller.

Introduction

Designed for LCD monitor and other flat panel display applications, ALR-1920-SDI is the single board solution for supporting ARGB, HDMI, Display Port, SDI input controller for driving the panel up to 1920x1200 resolution. This controller is the combo version for ALR-1920 and HD-3000S. This product design for the monitor series :

- TFT (active matrix) LCDs with LVDS interface of 1920x1200, 1920x1080, 1680x1050, 1600x1200, 1400x1050, 1440x900, 1366x768, 1280x1024, 1280x800, 1280x768, 1024x768, 1024x600, 800x600, 800x480, 640x480, 480x640 resolution
- Support HDMI, VGA, Display port, SDI input
- Support ARGB signal up to WUXGA resolution.
- Support HDMI 1.3 input up to 1080p/WUXGA resolution.
- Support single-link Display Port 1.1a
- Support 1.5Gbits & 3Gbits bit rate SDI input signal support
- SDI re-clock loop through output.
- Support LVDS interface panel

HOW TO PROCEED

- Ensure you have all parts & that they are correct, refer to:
 - Connection diagram (separate document for each panel)
 - Connector reference (in following section)
 - Assembly notes
- Check controller switch & jumper settings (errors may damage the panel)
- Prepare the PC
- Connect the parts
- Understand the operation and functions (in following section)

IMPORTANT USAGE NOTE

This product is for use by system developers and integrators, the manufacturer accepts no liability for damage or injury caused by the use of this product. It is the responsibility of the developer, integrators or other user of this product to:

- Ensure that all necessary and appropriate safety measures are taken.
- Obtain suitable regulatory approvals as may be required.
- Check power settings to all component parts before connection.
- Understand the operation and connectivity requirements of this controller.

DISCLAIMER

There is no implied or expressed warranty regarding this material.

SYSTEM DESIGN

A typical LCD based display system utilising this controller is likely to comprise the following:

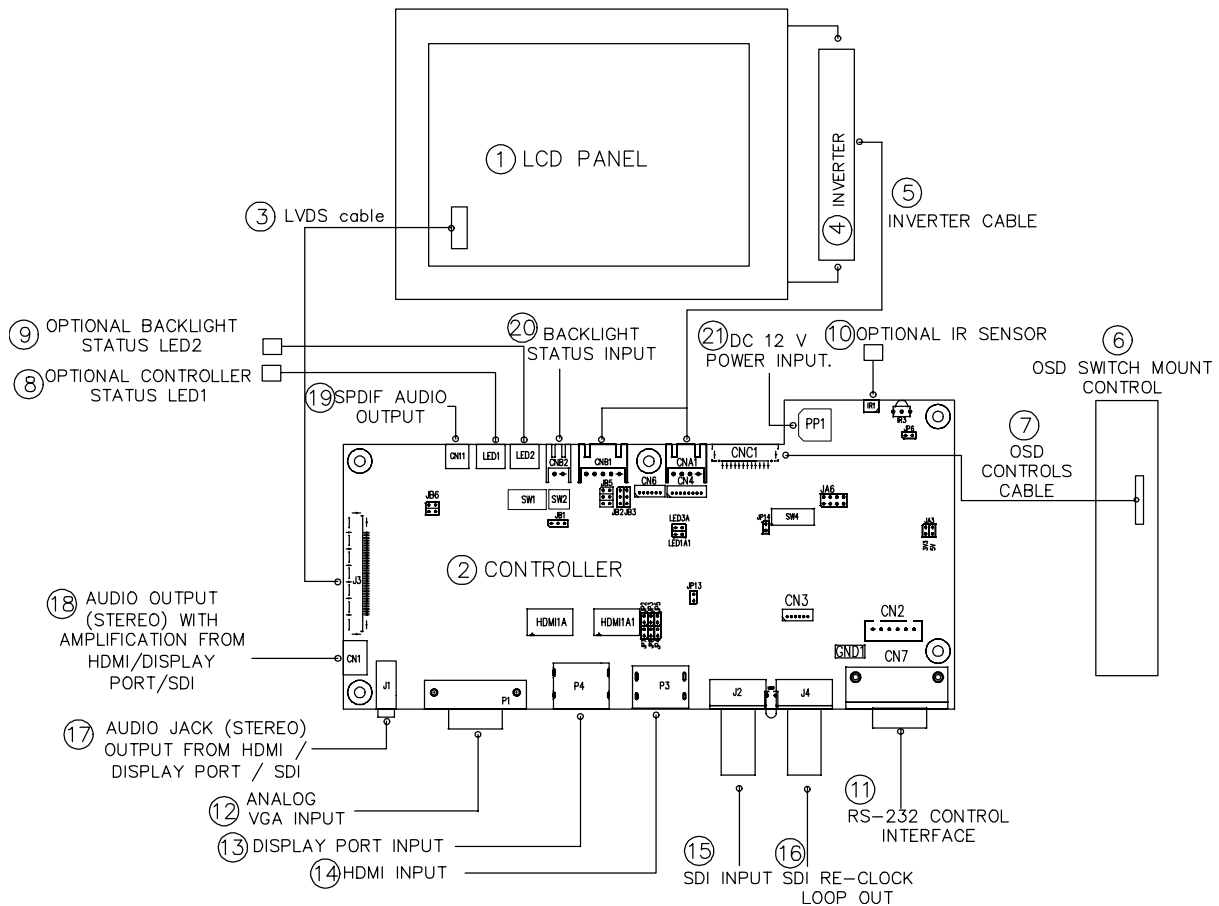

Summary:

1. LCD panel
2. LCD controller card, ALR-1920-SDI
3. LVDS cable (for connection with LVDS panel)
4. Inverter for backlight (if not built into LCD)
5. Inverter cable
6. OSD switch mount control
7. OSD controls cable
8. Optional Controller status LED1
9. Optional Backlight status LED2
10. Optional IR sensor
11. RS-232 control port
12. Analog VGA input
13. Display Port Input
14. HDMI input
15. SDI Input
16. SDI re-clock loop out
17. Audio Jack (Stereo) output from HDMI / Display Port / SDI
18. Audio output (Stereo) with amplification from HDMI / Display Port / SDI
19. SPDIF Audio output
20. Backlight status Input
21. Power input (12VDC)

Digital View offers a range of accessories such as listed above, to make up complete display solution.

ASSEMBLY NOTES

This controller is designed for monitor and custom display projects using 1920 x 1200, 1920 x 1080, 1680x1050, 1600x1200, 1400x1050, 1440x900, 1366x768, 1280x1024, 1280x800, 1280x768, 1024x768, 1024x600, 800x600, 800x480, 640x480, 480x640 resolution TFT panels with a VGA, SVGA, XGA, SXGA, UXGA, WUXGA signal input. The following provides some guidelines for installation and preparation of a finished display solution.

Preparation: Before proceeding it is important to familiarize yourself with the parts making up the system and the various connectors, mounting holes and general layout of the controller. As much as possible connectors have been labeled. Guides to connectors and mounting holes are shown in the following relevant sections.

- 1. LCD Panel:** This controller is designed for typical LVDS interface TFT panels with panel voltage 3.3V or 5V or 12V LVDS interface. Due to the variation between manufacturers of signal timing and other panel characteristics factory setup and confirmation should be obtained before connecting to a panel. **(NOTE: Check panel power jumper settings before connection)**
- 2. Controller card:** Handle the controller card with care as static charge may damage electronic components.
- 3. LVDS signal cable :** In order to provide a clean signal it is recommended that LVDS signal cables are no longer than 46cm (18 inches). If loose wire cabling is utilized these can be made into a harness with cable ties. Care should be taken when placing the cables to avoid signal interference. Additionally it may be necessary in some systems to add ferrite cores to the cables to minimize signal noise.
- 4. Inverter:** This will be required for the backlight of an LCD, some LCD panels have an inverter built in. As panels may have 1 or more backlight tubes and the power requirements for different panel models backlights may vary it is important to match the inverter in order to obtain optimum performance. See page 20 for the Application notes "Inverter connection section for more informations.
- 5. Inverter Cables:** Different inverter models require different cables and different pin assignment. Make sure correct cable pin out to match the inverter. Using wrong cable pin out may damage the inverter.
- 6. OSD switch mount controls:** The following section discusses the controls required and the section on connectors provides the detail. The controls are minimal: On/Off, Backlight Brightness (depends on inverter), OSD (5 momentary buttons) analog VR type or (8 momentary buttons) digital type.
- 7. OSD switch mount controls cable:** The cables to the function switches should be of suitable quality and length so that impedance does not affect performance. Generally lengths up to 1 metre (3 feet) should be acceptable.
- 8. Controller status LED (Optional) :** This LED indicates the controller status. The pin direction of the LED should be corrected for right colour indication. Red colour stands for standby. Green colours stands for signal on. The status LED is an optional part only, can be unconnected.

Controller LED status (LED1) :

State	LED color
No signal & backlight off	RED
No signal & backlight on	ORANGE
With signal & backlight on	GREEN

- 9. Backlight status LED (Optional) :** This LED indicates the backlight status. This function is only available when CNB2 are properly connected and the panel is support the backlight status function.

Backlight LED status (LED2) :

State	LED color
Backlight fault	RED
Backlight normal	GREEN

- 10. IR sensor:** It is an optional part only, can be unconnected if not using IR remote control. See Appendix V for button definition.
- 11. RS-232 control interface :** Firmware upgrade and serial control via this interface port.
- 12. Analog VGA Input Cable:** As this may affect regulatory emission test results and the quality of the signal to the controller, a suitably shielded cable should be utilized.
- 13. Display Port Cable :** Support single-link Display Port 1.1a. Plug the Display Port cable to the connector P4 on the controller board.
- 14. HDMI input :** Support HDMI 1.3 input up to 1080p/WUXGA resolution. Plug the HDMI cable to the connector P3 on the controller board.
- 15. SDI Input :** 3G/HD/SD-SDI signal input support. Plug the coaxial cable to the connector J2 on the controller board
- 16. SDI re-clock loop out :** 3G/HD/SD-SDI re-clock loop out. Recommend to connect less than 100 meter in good co-axial cable (e.g Belden 1694A) between DV devices.

17. Audio Jack (Stereo) output from HDMI / Display Port / SDI input : This port support Stereo audio output from the HDMI / Display Port / SDI audio source inputted. The audio handling is same as HD-3000 where 2 channels (stereo) of audio converted to HDMI output. Then the same HDMI audio handling as on the standard ALR-1920. It requires to select the appropriate input source and select the audio port "SPEAKERS" via OSD menu under "Sound" > "Output" OSD menu page.

18. Audio output (Stereo) with amplication from HDMI / Display Port / SDI input : This port support Stereo audio output from the HDMI / Display Port / SDI audio source inputted. The audio handling is same as HD-3000 where 2 channels (stereo) of audio converted to HDMI output. Then the same HDMI audio handling as on the standard ALR-1920. It requires to select the appropriate input source and select the audio port "SPEAKERS" via OSD menu under "Sound" > "Output" OSD menu page. This audio output will disable when audio jack (J1) being plugged.

19. SPDIF Audio output : This port support SPDIF audio output from the HDMI / Display Port / SDI audio source inputted. The audio handling is same as HD-3000 where 2 channels (stereo) of audio converted to HDMI output. Then the same HDMI audio handling as on the standard ALR-1920. It requires to select the appropriate input source and select the audio port "SPDIF" via OSD menu under "Sound" > "Output" OSD menu page.

20. Backlight status input : It only functions when connecting with the panel which support backlight status detection pin.

21. Power Input: 12VDC is required, this should be a regulated supply. Although the controller provides power regulation for the LCD power this does not relate to the power supplied to the backlight inverter. If an unregulated power supply is provided to an inverter any fluctuations in power may affect operation, performance and lifetime of the inverter and or backlight tubes.

- **Power Safety:** Note that although only 12VDC is supplied as 'power-in' a backlight inverter for panel backlighting produces significantly higher voltages (the inverter does not connect to the ground plane). We strongly advise appropriate insulation for all circuitry.
- **EMI:** Shielding will be required for passing certain regulatory emissions tests. Also the choice of external Controller to PC signal cable can affect the result.
- **Ground:** The various PCB mounting holes are connected to the ground plane.
- **Servicing:** The board is not user serviceable or repairable. Warranty does not cover user error in connecting up to the controller and is invalidated by unauthorized modification or repairs.
- **Controller Mounting:** It is recommended that a clearance of at least 10mm is provided above and 5mm below the controller when mounted. Additionally consideration should be given to:
 - Electrical insulation.
 - Grounding.
 - EMI shielding.
 - Cable management. Note: It is important to keep panel signal cables apart from the inverter & backlight cables to prevent signal interference.
 - Heat & Ventilation: Heat generated from other sources, for example the backlight of a very high brightness panel may generate significant heat which could adversely affect the controller.
 - Other issues that may affect safety or performance.
- **PC Graphics Output:** A few guidelines:
 - Signal quality is very important, if there is noise or instability in the PC graphics output this may result in visible noise on the display.
 - Refer to graphics modes table in specifications section for supported modes.
 - Non-interlaced & interlaced video input is acceptable.

IMPORTANT: Please read the Application Notes section for more information.

CONNECTION & OPERATION

CAUTION: Never connect or disconnect parts of the display system when the system is powered up as this may cause serious damage.

CONNECTION

Connection and usage is quite straight forward (it is useful to have the relevant connection diagram available at this time):

1. **LCD panel & Inverter:** Connect the inverter (if it is not built-in the panel) to the CCFT lead connector of the LCD panel.
2. **LVDS type panels:** Plug the LVDS signal cable direct to J3 (if necessary). Insert the panel end of the cable to the LCD panel connector.
3. **Inverter & Controller:** Plug the inverter cable to CNB1 and CNA1 (if necessary). Plug another end to the connector on the inverter.
4. **Function switch & Controller:** Plug the OSD switch mount cable to CNC1 on the controller board and another to the OSD switch mount.
5. **LED 1 :** Plug in a 3-way with dual colour LED to connector LED1 on the controller board for indicating the controller status.
6. **LED 2 :** Plug in a 3-way with dual color LED to connector LED2 on the controller board for indicating the backlight status. This function is only available when CNB2 are proper connected and the panel is support the backlight status function.
7. **IR & Controller:** Plug in a 3-way with IR sensor to connector IR1 on the controller board.
8. **Jumpers :** Check all jumpers are set correctly. Details referring the connection diagram at <http://www.digitalview.com/controllers/csg.php>
9. **Jumpers & Inverter & Panel voltage:** Particularly pay attention to the settings of JA3, JA6, JB2, JB3. JB2 & JB3 are used for inverter control (read inverter specification and information on the jumper table to define the correct settings). JA3 & JA6 are used for panel voltage input (read panel specification and information on the jumper table to define the correct settings).
10. **HDMI cable :** Plug the HDMI cable to the connector P3 on the controller board.
11. **VGA cable :** Plug the VGA cable to the connector P1 on the controller board.
12. **Display port cable :** Plug the Display port cable to connector P4 on the controller board.
13. **SDI input cable :** Plug the coaxial cable to connector J2 on the controller board for SDI input cable. Plug another coaxial cable to J4 for re-clock loop out. Recommend to connect less than 100 meter in good co-axial cable (e.g Belden 1694A) between DV devices.
14. **Audio output jack / SPDIF audio connector :** audio output ports CN1 & J1 support audio output (stereo) from the HDMI / Display Port and CN11 support audio SPDIF audio output from HDMI / Display Port audio source inputted. It requires to select the audio port "Speakers" / "SPDIF" via OSD menu under "Sound" > "Output" OSD menu page.
15. **Power supply & Controller:** Plug the DC 12V power in to the connector PP1. You can consider to use DigitalView mating power cable P/N 426013800-3, 160mm.
16. **Power on:** Switch on the controller board and panel by using the OSD switch mount.

CAUTION: Never connect or disconnect parts of the display system when the system is powered up as this may cause serious damage.

Controller LED status (LED1 & LED1A) :

State	LED color
No signal & backlight off	RED
No signal & backlight on	ORANGE
With signal & backlight on	GREEN

Backlight LED status (LED2 & LED2A) :

State	LED color
Backlight fault	RED
Backlight normal	GREEN

General:

- If you are using supplied cables & accessories, ensure they are correct for the model of panel and controller.
- If you are making your own cables & connectors refer carefully to both the panel & inverter specifications and the section in this manual, "Connectors, Pinouts & Jumpers" to ensure the correct pin to pin wiring.

PC SETTINGS

The controller has been designed to take a very wide range of input signals however to optimize the PC's graphics performance we recommend choosing 60Hz vertical refresh rate – this will not cause screen flicker.

OPERATION

Once the system has been connected and switched on there are a number of functions available to adjust the display image as summarized in the following sections. The settings chosen will be saved for each mode independently.

LCD DISPLAY SYSTEM SETTINGS

NOTE: By way of explanation the following refers to a set of sample buttons that may be obtained as an option. In addition to power on/off and connection for backlight brightness the controller provides an On Screen Display of certain functions which are controlled by 5 momentary type buttons (analog VR type) or 8 momentary type buttons (digital type):

Controls	Analog VR type	Digital type
On/Off – turns controller board power on	VR toggle switch	On/Off button
Brightness – controls backlight brightness	Rotary VR	Brightness +/- buttons
Menu – turns OSD menu On or Off (it will auto time off) (Function with signal input only)	Menu button	Menu button
Select – Select function / Confirm (under OSD menu on state)	SEL DN	SEL DN
Move up to select individual RGB color level OSD page (under OSD menu on state)	SEL UP	SEL UP
+ – increase the setting / moves the selector to the next function (under OSD menu on state)	+	+
- - decrease the setting / moves the selector to the previous function (under OSD menu on state)	-	-
Reset to Factory Defaults	Press and hold SEL DN button, then power on the controller	Press and hold SEL DN button, then power on the controller
Switch to next input source (under OSD menu off state)	+	+
Volume adjustment (under OSD menu off state)	SEL UP / SEL DN	SEL UP / SEL DN

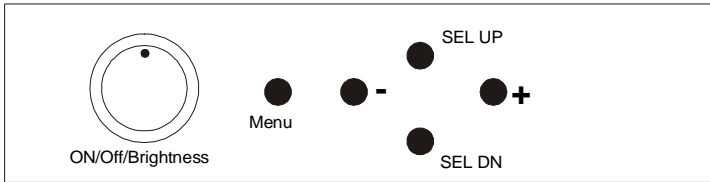

Analog VR type



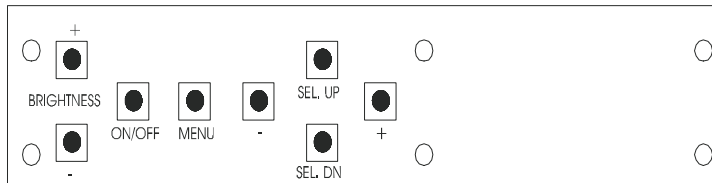

























Analog 10K VR Type OSD switch mount uses P/N 410680550-3 or up





Digital type

Digital 10K Type OSD switch mount uses P/N 416100520-3 or up

OSD Functions

		Image	
	Brightness	Increase/decrease brightness level. Press – or + (-  +) Total : 100 steps	
	Contrast	Increase/decrease contrast level. Press – or + (-  +) Total : 100 steps	
	Sharpness	Increase/decrease sharpness level. Press – or + (-  +) Total : 8 steps	
	Color	Auto : Auto RGB Calibration ([See appendix IV] in details) (Function in ARGB mode only)	
		Color temp ▶ (Adjust the warmness of the image displayed. The higher temperature the coolest image looks like. The lower temperature the warmest image looks like. Function in ARGB mode only) 4200k 5000k 6500k 7500k 9300k User ▶ R Press – or + (-  +) Total : 100 steps G Press – or + (-  +) Total : 100 steps B Press – or + (-  +) Total : 100 steps  Reset Gamma (0.4/0.6/1.0/1.6/2.2)	
		Display (Function in ARGB mode only)	
	Auto Adjust	Auto adjust the positions, phase, frequency	
	Phase	Fine tune the data sampling position (adjust image quality) Press – or + (-  +) Total : 100 steps	
	Clock	Adjust the image horizontal size Press – or + (-  +) Total : 100 steps	
	Display Position	Adjust image position	
		Sound (Function when HDMI, Display Port, SDI connected and selected)	
	Volume	Increase/decrease volume level, total: 100 steps Press – or + (-  +) Total : 100 steps	
	Mute	Mute	
	Output	Select audio output port Speakers : via CN1 & J1 connector SPDIF : via CN11 connector	
		System ▶	
	Input source select	Input : Select the input video signal Display Port VGA DVI/HDMI SDI Autoscan : Enable the Auto source seek function	
	OSD menu		
		Timer : OSD Timeout in seconds 3 sec 6 sec 12 sec Always On	
		Rotation : OSD menu rotation in degree 0 90 180 270	

	 MENU	Position : Adjust OSD menu position
	 MENU	Transparency : Set OSD transparency Press - or + (- <input type="text"/> +) Total : 100 steps
		Reset : Load factory default settings. Press down on OSD keypad to factory reset
	TEMP	Reporting the on board temperature (°C)

[Firmware version : V1.02.00 or up]

Items marked ▶ have sub menus.
Exit the OSD menu to save the setting chosen

On board temperature reading :

This controller has a built in on board temperature sensor on U4 which can report the on board temperature reading on OSD menu. (See below) :

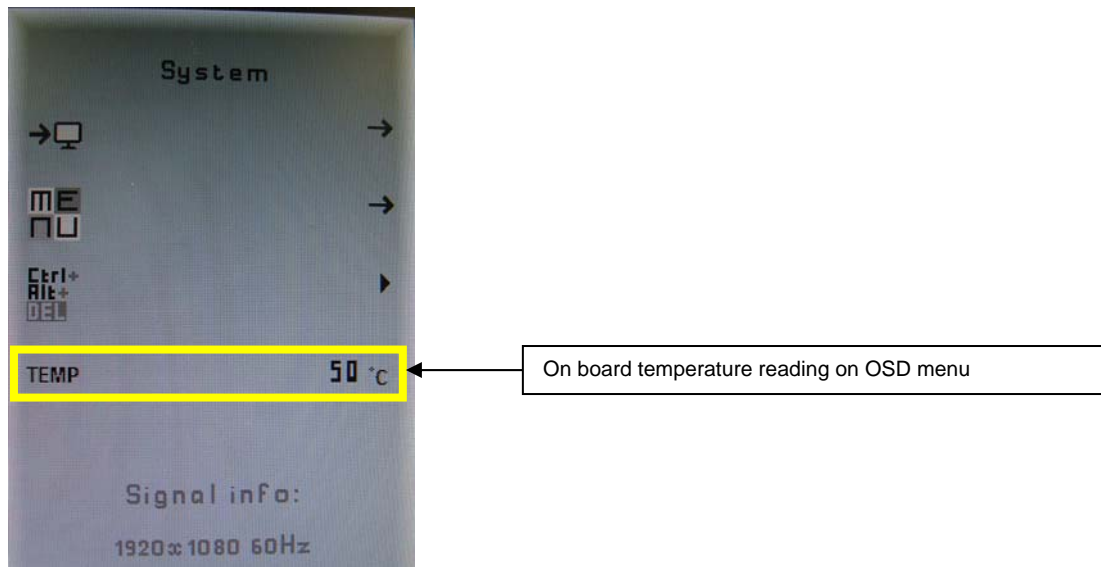

CONNECTORS, PINOUTS & JUMPERS

The various connectors are:

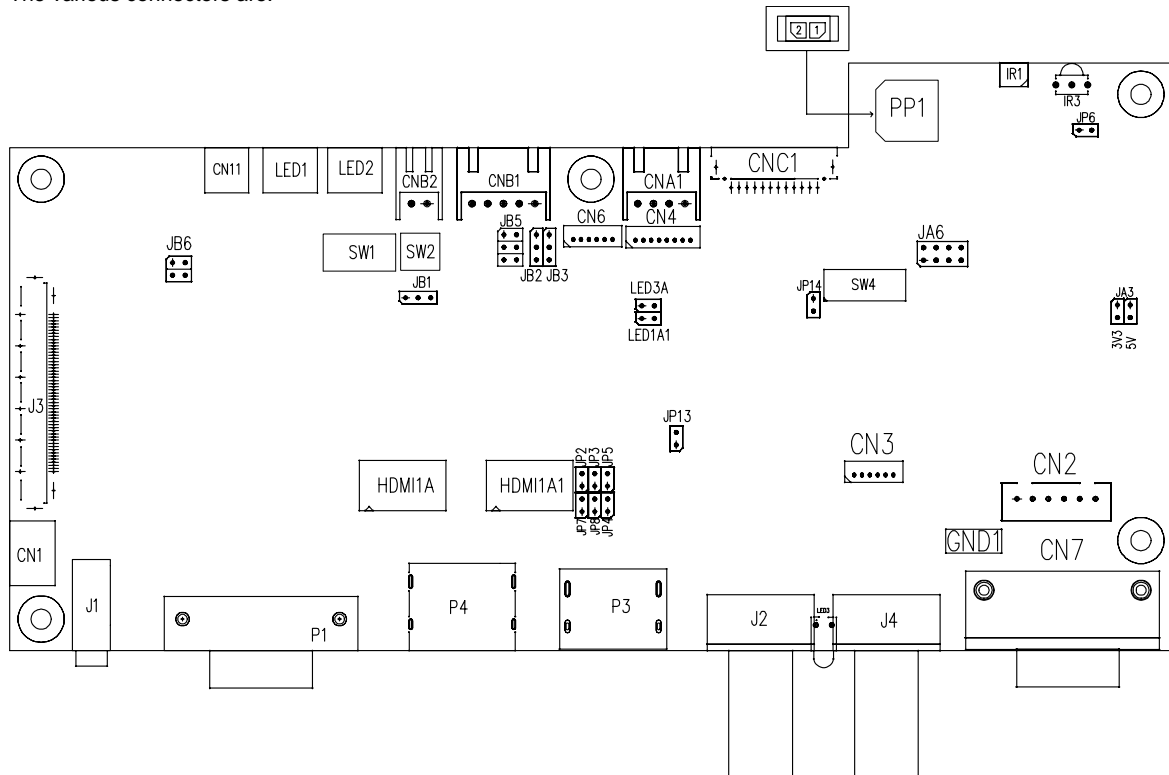

Summary: Connectors

Ref	Purpose	Description
CN1	Audio output (Stereo) with amplication from HDMI / Display port / SDI	JST 4-way, S4B-ZR-SM4A (Mating type : ZHR-4) (Matching connection cable P/N 426685400-3)
CN2	Reserved for internal firmware upgrade for SDI part circuitry	JST 6-way, B6B-XH-A (Mating type : XHP-6)
CN3	Reserved	For factory use only.
CN4	Reserved	For factory use only.
CN6	Reserved	For factory use only.
CN7	Serial control	DB9 Female connector
CN11	SPDIF Audio Output	JST 2-way, S2B-ZR-SM4A (Mating type : ZHR-2) (Matching connection cable P/N 426007400-3)
CNA1	Auxiliary power output	JST 4-way, S4B-XH-A (Mating type : XHP-4) (Matching cable P/N 426040200-3)
CNB1	Backlight inverter	JST 5-way, S5B-XH-A (Mating type : XHP-5) (Matching cable P/N 426058300-3)
CNB2	Backlight status input	JST 2-way, S2B-XH-A (Mating type : XHP-2) (Matching cable P/N 426020800-3)
CNC1	OSD controls	Hirose DF13A-12P-1.25H (Mating type : DF13-12S-1.25C) (Matching OSD switch mount cable P/N 426122210-3 (250mm) or 426122210-3 (150mm))
HDMI1A	Reserved	No function
HDMI1A1	Reserved	No function
IR1	Infra-Red sensor connector	Molex 53261-0371, 3 way 1.25mm pitch (Mating type : 51021-0300) (Matching connection cable P/N 426031500-3)
IR3	Infra-Red sensor	IR sensor on board
LED1	Dual color LED connector for controller status	JST 3-way, S3B-ZR-SM4A (Mating type : ZHR-3) (Matching connection cable P/N 426031400-3)
LED2	Dual color LED connector for backlight status	JST 3-way, S3B-ZR-SM4A (Mating type : ZHR-3) (Matching connection cable P/N 426031400-3)
J1	Audio jack (Stereo) output from HDMI / Display Port / SDI	3.5mm PHONE JACK
J2	SDI input	BNC connector
J3	LVDS panel signal	JAE FI-RE51S-HF (Mating type : JAE FI-RE51HL)
J4	SDI re-clock loop through output.	BNC connector
P1	ARGB signal input	DB-15 way high density 3 row
P3	HDMI signal input	HDMI connector (Type A)
P4	Display Port input	Display port connector
PP1	Power input	Molex 43650-0200 compatible (Mating type : Molex 43645-0200 compatible) (Matching power cable : P/N 426013800-3, 160mm)

Summary: Jumpers setting

Ref	Purpose	Note
LED3A	Reserved	Reserved for internal use only
LED1A1	Reserved	Reserved for internal use only
JA3	Panel power voltage select	See panel voltage setting table 1 CAUTION: Incorrect setting will cause panel damage
JA6	Panel power voltage select	See panel voltage setting table 1 CAUTION: Incorrect setting will cause panel damage
JB1	Backlight brightness voltage range	1-2 closed = 3.3V max 2-3 closed = 5V max
JB2	Backlight inverter on/off control – signal level	1-2 = On/Off control signal 'High' = +12V 2-3 = On/Off control signal 'High' = +5V Open = On/Off control signal 'High' = Open collector CAUTION: Incorrect setting can damage inverter.
JB3	Backlight inverter on/off control – polarity	1-2 = control signal 'high' = CCFT ON 2-3 = control signal 'low' = CCFT ON
JB5	Backlight control type selection	1-2 = VR/Digital switch mount control 3-4 = Analog backlight brightness control via RS-232 command (0xe0) – voltage range 0~5V 5-6 = Reserved
JB6	Backlight status	1-2, 3-4 closed = Backlight status Low – Normal 1-3, 2-4 closed = Backlight status High - Normal Open = Backlight status not used
JP1	Reserved	Reserved for internal programming use (Always 1-2 closed)
JP2	Reserved	Reserved for internal use only
JP3	Reserved	Reserved for internal use only
JP4	Reserved	Reserved for internal use only
JP5	Reserved	Reserved for internal use only
JP6	Reserved	Reserved for internal use only
JP7	Reserved	Reserved for internal use only
JP8	Reserved	Reserved for internal use only
JP6	Input power control	Short = External switch control Open = Switch mount control
JP13	Reserved	Reserved for factory use
JP14	Reserved	Reserved for factory use
SW1	Panel selection	See table below
SW2	Panel selection	See table below
SW4	Reserved	Reserved for internal use only

Table 1 : Panel voltage setting table :

Input voltage via PP1	Panel Voltage	JA3	JA6	Jumper on board
12VDC	3.3V	3V3 closed	1-3 & 2-4	
	5V	5V closed	1-3 & 2-4	
	12V	OPEN	5-7 & 6-8	

CAUTION: Incorrect setting can damage panel & controller

JA3 & JA6 location on board : (Please pay attention to the jumper settings on JA3 & JA6 which are red in color on board)

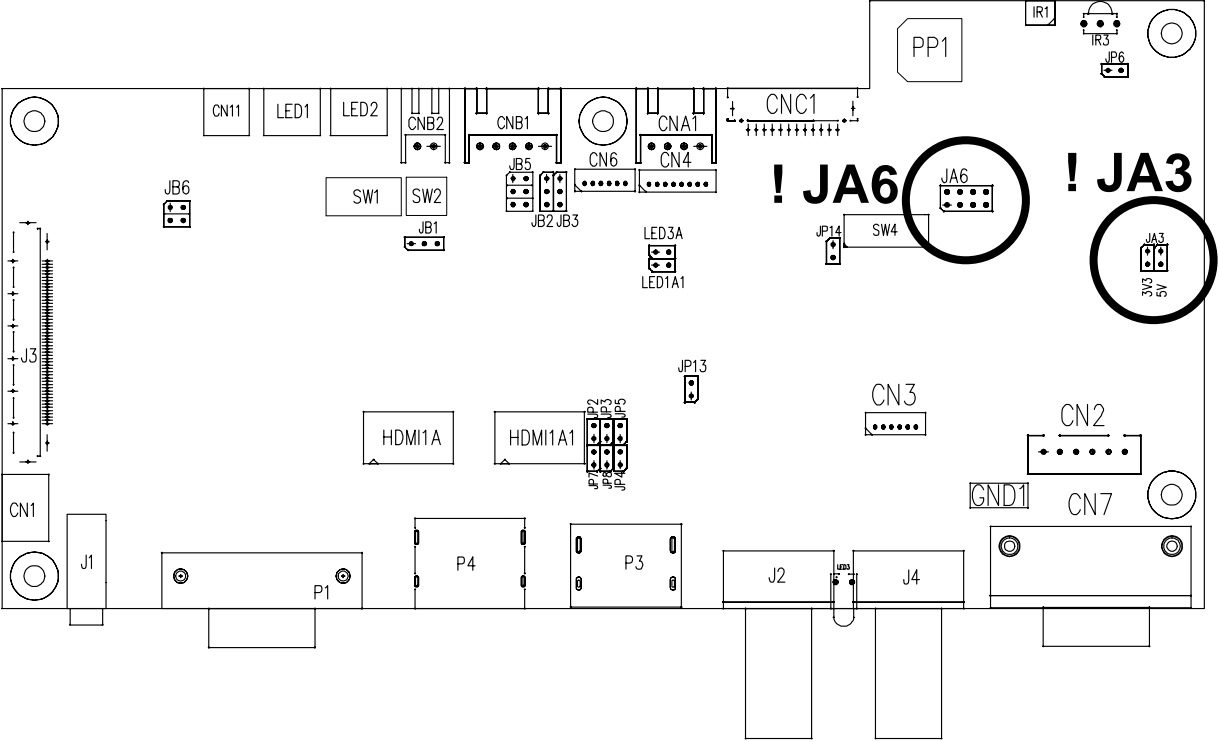

DIP Switch selection – SW1

Pos #1	Pos #2	Pos #3	Pos.#4	Description	Panel resolution
For WUXGA panel					
OFF	OFF	OFF	OFF	Samsung LTM220CS01 (Tested) AU Optronics B170UW02 V0	1920x1200 1920x1200
ON	OFF	OFF	OFF	AU Optronics M215HW01 (Tested) Samsung LTM230HT01	1920x1080 1920x1080
For UXGA panel					
ON	OFF	OFF	OFF	NEC NL160120BC27-14	1600x1200
For WXGA panel					
ON	OFF	OFF	OFF	Samsung LTA260W2-L01	1366x768
ON	ON	OFF	OFF	Samsung LTA460WS-L03	1366x768
OFF	OFF	ON	OFF	Sharp LQ315T3LZ24 / AU Optronics M156XW01 V0	1366x768
ON	OFF	ON	OFF	LG LC420W02-A4	1366x768
OFF	ON	ON	OFF	NEC NL12880BC20-02D	1280x800
OFF	ON	OFF	OFF	NEC NL12876BC26-21	1280x768
ON	ON	ON	OFF	AU Optronics M220EW01	1680x1050
For SXGA panels					
ON	OFF	OFF	ON	NEC NL128102BC29-01B	1280x1024
ON	ON	ON	OFF	Fujitsu FLC48SXC8V	1280x1024
OFF	ON	OFF	ON	Sharp LQ181E1LW31	1280x1024
ON	ON	OFF	ON	Samsung LTM170ET01	1280x1024
OFF	OFF	ON	ON	AU Optronics M190EG01	1280x1024
For XGA panel					
OFF	OFF	ON	ON	AUO M150XN07 V2 (Tested)	1024x768
OFF	ON	ON	OFF	LG LM151X2	1024x768
ON	ON	OFF	ON	Sharp LQ150X1LGB1 Sharp LQ150X1LGN2A	1024x768 1024x768
ON	OFF	ON	ON	NEC NL10276BC12-02	1024x768
OFF	ON	ON	ON	NEC NL10276BC13-01C	1024x768
ON	ON	ON	ON	NEC NL10276BC30-18/ 30-18C NEC NL10276BC20-08	1024x768 1024x768
For SVGA panel					
OFF	OFF	ON	OFF	PrimeView PD104SL5H2 Sharp LQ121S1DG11 Sharp LQ104S1DG21 Sharp LQ121S1DG41	800x600 800x600 800x600 800x600
ON	OFF	ON	OFF	Toshiba LTM12C289	800x600
OFF	ON	ON	OFF	Sharp LQ084S3DG01	800x600
ON	ON	OFF	OFF	Sharp LQ121S1LG41 NEC NL8060BC21-02	800x600 800x600
ON	ON	ON	OFF	Sharp LQ104S1DG21	800x600
OFF	OFF	OFF	ON	PrimeView PD104SL5	800x600
For WVGA panel					
ON	OFF	ON	OFF	NEC NL8048BC19-02	800x480
ON	OFF	OFF	ON	Sharp LQ070Y3LG4A	800x480
Others					
ON	ON	ON	OFF	AU Optronics M200RW01 V1 (Tested)	1600x900
ON	OFF	OFF	OFF	Sharp LQ150F1LH22	1400x1050
ON	ON	OFF	OFF	Samsung LTM190M2-L31	1440x900
ON	OFF	ON	OFF	LG LM171WX3-TLA1	1440x900
OFF	ON	ON	OFF	LG LM171WX3 (Tested)	1440x900
OFF	OFF	ON	OFF	CPT CLAA102NA0ACW	1024x600

For additional and recent added panels, see ALR-1920-SDI panel support table at <http://www.digitalview.com/controllers/csg.php>

Pos #5	Pos #6	Pos #7	Description
OFF	OFF	OFF	WUXGA
ON	OFF	OFF	UXGA
OFF	ON	OFF	SXGA
ON	ON	OFF	WXGA
OFF	OFF	ON	XGA
ON	OFF	ON	SVGA
OFF	ON	ON	VGA / WVGA
ON	ON	ON	Others

SW1 Pos 8 = Reserved.

DIP switch selection – SW2

Pos. #	Function	Description
1	Panel pixel format	OFF : Double Pixel ON : Single Pixel
2	LVDS data mapping select	ON : Mapping A (LVDS panel) OFF : Mapping B (LVDS panel) Please adjust to get the correct picture. See as Appendix III for details of mapping A and B.
3	Reserved	Reserved
4	Reserved	Reserved

The most current list can be found the controller solution generator at <http://www.digitalview.com/controllers/csg.php>

CN1 – Audio output (Stereo) with amplification from HDMI / Display port : JST 4-way, S4B-ZR-SM4A

(Mating type : ZHR-4)

PIN	SYMBOL	DESCRIPTION
1	AMP L-	Audio Left channel (Negative)
2	AMP L+	Audio Left channel (Positive)
3	AMP R-	Audio Right channel (Negative)
4	AMP R+	Audio Right (Positive)

CN7 – Serial control, DB9 Female connector

PIN	SYMBOL	DESCRIPTION
1	NC	No connection
2	RS-232_Tx	RS-232 Tx Data
3	RS-232_Rx	RS-232 Rx Data
4	NC	No connection
5	GND	Ground
6	NC	No connection
7	NC	No connection
8	NC	No connection

CN11 – SPDIF Audio Output JST 2-way, S2B-ZR-SM4A

(Mating type : JST ZHR-2)

PIN	SYMBOL	DESCRIPTION
1	SPDIF_OUT	SPDIF audio out
2	GND	Ground

CNA1 - Auxiliary power output: JST S4B-XH-A

(Matching type : XHP-4)

PIN	SYMBOL	DESCRIPTION
1	AUX POWER	+12V DC, 500mA max
2	GND	Ground
3	GND	Ground
4	AUX 5V	+5V DC, 500mA max

CNB1 – Backlight inverter connector: JST S5B-XH-A

(Matching type : XHP-5)

PIN	SYMBOL	DESCRIPTION
1	GND	Ground
2	VBKL	Backlight power supply, +12VDC
3	BLCTRL	Backlight On/Off control signal (refer to JB2 & JB3)
4	BVR_WIP	Backlight brightness VR pin WIP
5	BVR_A	Backlight brightness VR pin A

CNB2 – Backlight status connector : JST B2B-XH-A

(Matching type : XHP-2)

PIN	SYMBOL	DESCRIPTION
1	BL_S	Backlight status signal
2	GND	Ground

CNC1 – OSD switch mount control, Hirose DF13A-12P-1.25H

(Mating type : DF13-12S-1.25C)

PIN	SYMBOL	DESCRIPTION
1	PSWIN	Power button A
2	SW_ON	Power button B
3	BVR_A	Backlight Brightness VR pin A
4	BVR_WIP	Backlight Brightness VR pin WIP
5	BVR_B	Backlight Brightness VR pin B (470 ohm resistor to +5V Vcc)
6	GND	Ground
7	MENU	OSD menu
8	-/LEFT	OSD -/Left
9	+/RIGHT	OSD +/Right
10	SEL_DN	OSD Select down
11	SEL_UP	OSD Select up
12	NC	No connection

IR1 – Infra-Red sensor connector: Molex 53261-0371, 3 way 1.25mm pitch (Matching type : Molex 51021-0300)

PIN	SYMBOL	DESCRIPTION
1	GND	Ground
2	STDBY_Vcc	Stand by voltage
3	IR Data	IR data

J3 – LVDS output connector: JAE FI-RE51S-HF (Matching type : JAE FI-RE51HL)

PIN	SYMBOL	DESCRIPTION
1	VDD (+12V)	Panel power supply (+12V) (selected by JA3 & JA6)
2	VDD (+12V)	Panel power supply (+12V) (selected by JA3 & JA6)
3	VDD (+12V)	Panel power supply (+12V) (selected by JA3 & JA6)
4	VDD (+12V)	Panel power supply (+12V) (selected by JA3 & JA6)
5	VDD (+12V)	Panel power supply (+12V) (selected by JA3 & JA6)
6	VDD (3,3V/5V)	Panel power supply (3,3V/5V) (selected by JA3 & JA6)
7	VDD (3,3V/5V)	Panel power supply (3,3V/5V) (selected by JA3 & JA6)
8	VDD (3,3V/5V)	Panel power supply (3,3V/5V) (selected by JA3 & JA6)
9	VDD (3,3V/5V)	Panel power supply (3,3V/5V) (selected by JA3 & JA6)
10	VDD (3,3V/5V)	Panel power supply (3,3V/5V) (selected by JA3 & JA6)
11	GND	Ground
12	GND	Ground
13	GND	Ground
14	GND	Ground
15	GND	Ground
16	NC	No connection
17	NC	No connection
18	NC	No connection
19	NC	No connection
20	GND	Ground
21	GND	Ground
22	NC	No connection
23	NC	No connection
24	TXA3+	Positive differential LVDS data bit A3
25	TXA3-	Negative differential LVDS data bit A3
26	GND	Ground
27	TXAC+	Positive LVDS clock for A channel
28	TXAC-	Negative LVDS clock for A channel
29	GND	Ground
30	TXA2+	Positive differential LVDS data bit A2
31	TXA2-	Negative differential LVDS data bit A2
32	TXA1+	Positive differential LVDS data bit A1
33	TXA1-	Negative differential LVDS data bit A1
34	TXA0+	Positive differential LVDS data bit A0
35	TXA0-	Negative differential LVDS data bit A0
36	GND	Ground
37	NC	No connection
38	NC	No connection
39	TXB3+	Positive differential LVDS data bit B3
40	TXB3-	Negative differential LVDS data bit B3
41	GND	Ground
42	TXBC+	Positive LVDS clock for B channel
43	TXBC-	Negative LVDS clock for B channel
44	GND	Ground
45	TXB2+	Positive differential LVDS data bit B2
46	TXB2-	Negative differential LVDS data bit B2
47	TXB1+	Positive differential LVDS data bit B1
48	TXB1-	Negative differential LVDS data bit B1
49	TXB0+	Positive differential LVDS data bit B0
50	TXB0-	Negative differential LVDS data bit B0
51	GND	Ground

LED1 – Dual color LED connector for controller status, JST 3-way, S3B-ZR-SM4A (Mating type : JST ZHR-3)

PIN	DESCRIPTION
1	Green LED pin (anode)
2	LED pin common (cathode)
3	Red LED pin (anode)

LED2 – Dual color LED connector for backlight status, JST 3-way, S3B-ZR-SM4A (Mating type : JST ZHR-3)

PIN	DESCRIPTION
1	Green LED pin (anode)
2	LED pin common (cathode)
3	Red LED pin (anode)

P1 - Analog VGA input – DB-15 way high density 3 row

PIN	SYMBOL	DESCRIPTION
1	PCR	Red, analog
2	PCG	Green, analog
3	PCB	Blue analog
4	ID2	Reserved for monitor ID bit 2 (grounded)
5	DGND	Digital ground
6	AGND	Analog ground red
7	AGND	Analog ground green
8	AGND	Analog ground blue
9	DDC_5V	+5V power supply for DDC (optional)
10	DGND	Digital ground
11	ID0	Reserved for monitor ID bit 0 (grounded)
12	DDC_SDA	DDC serial data
13	HS_IN	Horizontal sync or composite sync, input
14	VS_IN	Vertical sync, input
15	DDC_SCL	DDC serial clock

P3 – HDMI connector

PIN	SYMBOL	DESCRIPTION
1	DATA2+	TMDS Data2+
2	DATA2S	TMDS Data2 Shield
3	DATA2-	TMDS Data2-
4	DATA1+	TMDS Data1+
5	DATA1S	TMDS Data1 Shield
6	DATA1-	TMDS Data1-
7	DATA0+	TMDS Data0+
8	DATA0S	TMDS Data0 Shield
9	DATA0-	TMDS Data0-
10	CLK+	TMDS Clock+
11	CLK@	TMDS Clock Shield
12	CLK-	TMDS Clock-
13	CEC	CEC
14	NC	No connection
15	SCL	SCL (I ² C Serial Clock for DDC)
16	SDA	SDA (I ² C Serial Data Line for DDC)
17	CEC/GND	Ground
18	+5V	+5 V Power (max 50 mA)
19	HPDET	Hot Plug Detect

P4 – Display Port input

PIN	SYMBOL	DESCRIPTION
1	ML_Lane 0 (p)	Lane 0 (positive)
2	GND	Ground
3	ML_Lane 0 (n)	Lane 0 (negative)
4	ML_Lane 1 (p)	Lane 1 (positive)
5	GND	Ground
6	ML_Lane 1 (n)	Lane 1 (negative)
7	ML_Lane 2 (p)	Lane 2 (positive)
8	GND	Ground
9	ML_Lane 2 (n)	Lane 2 (negative)
10	ML_Lane 3 (p)	Lane 3 (positive)
11	GND	Ground
12	ML_Lane 3 (n)	Lane 3 (negative)
13	CONFIG1	connected to Ground ¹⁾
14	CONFIG2	connected to Ground ¹⁾
15	AUX CH (p)	Auxiliary Channel (positive)
16	GND	Ground
17	AUX CH (n)	Auxiliary Channel (negative)
18	Hot Plug	Hot Plug Detect
19	GND	Ground
20	DP_PWR	Power for connector (3.3 V 500 mA)

PP1 - Power supply

(Mating type : Molex 43645-0200 compatible)

PIN	DESCRIPTION
1	+12VDC 5A max
2	Ground

CONTROLLER DIMENSIONS

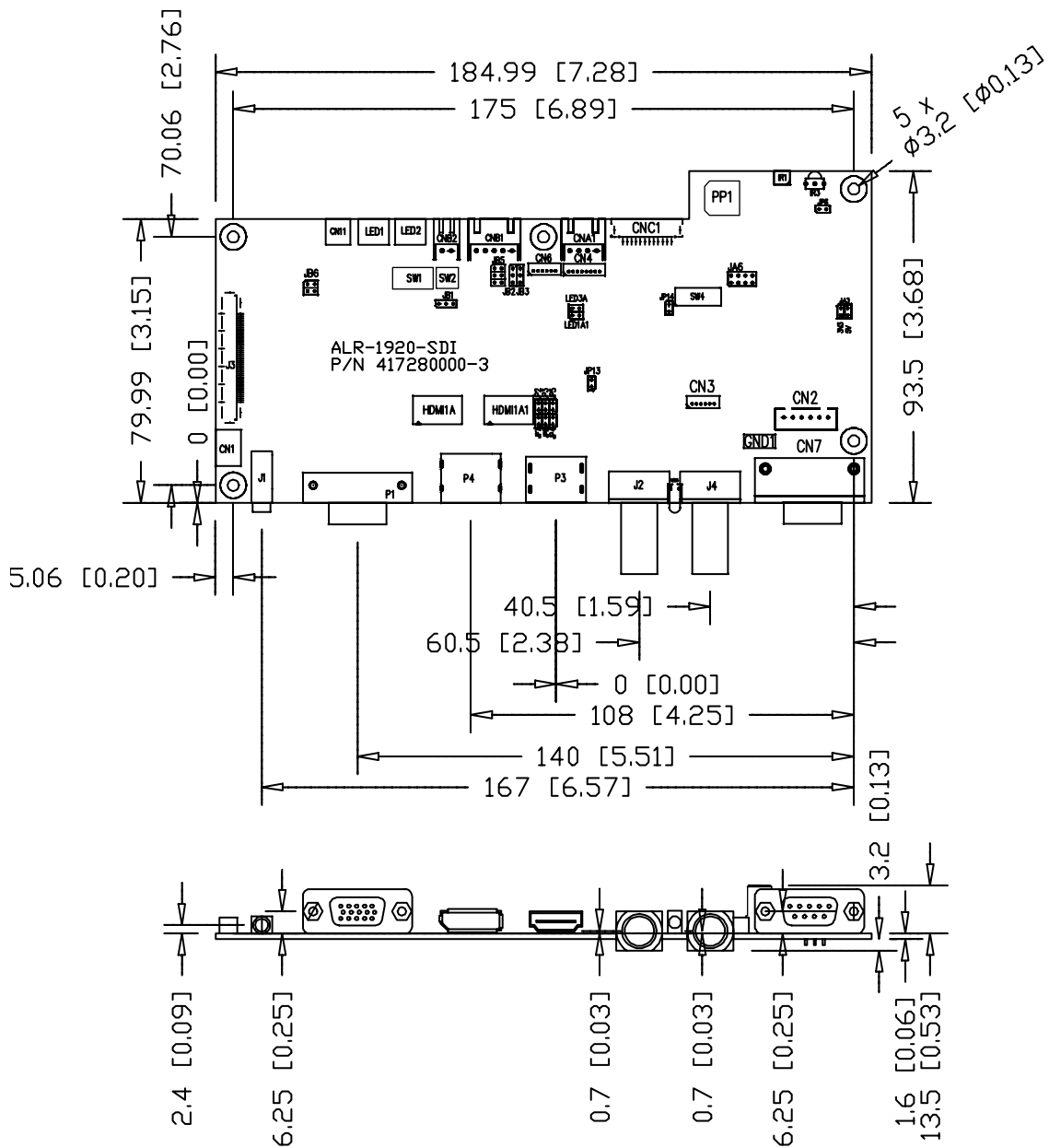

The maximum thickness of the controller is 18.3mm (measured from bottom of PCB to top of components, including any underside components & leads). We recommend clearances of:

- 5mm from bottom of PCB - if mounting on a metal plate we also recommend a layer of suitable insulation material is added to the mounting plate surface.
- 10mm above the components
- 3-5mm around the edges

Any of the holes shown above can be used for mounting the PCB, they are 3.2mm in diameter.

CAUTION: Ensure adequate insulation is provided for all areas of the PCB with special attention to high voltage parts such as the inverter.

APPLICATION NOTES

USING THE CONTROLLER WITHOUT BUTTONS ATTACHED

This is very straightforward by following the steps below :

- Firstly setup the controller/display system with the buttons. With controls attached and display system active make any settings for colour and image position as required then switch everything off.
- Use a jumper to close JP6 jumper, this will fix the board On.
- Refer to inverter specifications for details as to fixing brightness to a desired level, this may require a resistor, an open circuit or closed circuit depending on inverter.

INVERTER CONNECTION

There are potentially 3 issues to consider with inverter connection:

- Power
- Enable
- Brightness

Please read the following sections for a guide to these issues.

Inverter Power: As per the table for CNB1 pin 1 is ground and pin 2 provides DC12V DC . This should be matched with the inverter specification: see table.

CNB1

PIN	DESCRIPTION
1	Ground
2	+12VDCVDC

Remark: For higher power inverter, more current (for 12V) can be taken from CNA1 pin 1. Maximum current drawn on CNA1 pin 1 and CNB1 pin 2 is 3A(12V)

Enable: This is a pin provided on some inverters for On/Off function and is used by this panel controller for VESA DPMS compliance. If the inverter does not have an enable pin or the enable pin is not used then DPMS will not be operational. Pin 3 should be matched to the inverters specification for the 'enable' or 'disable' pin.

CNB1

PIN	DESCRIPTION
3	Enable

Further, jumpers JB2 & JB3 should be set to match the inverters specification for the enable pin power and High or Low setting: see table.

Ref	Purpose	Note
JB2	Inverter enable voltage	1-2 H = 12V, 2-3 H = 5V (Vcc), OPEN H = open collector
JB3	Inverter control	1-2 H = On, 2-3 L = On

Brightness: There are various methods for brightness control and it is important to consider the specifications for the inverter to be used. Generally the situation is:

- Brightness can controlled by using a resistor or VR (Variable Resistor).
- Brightness controlled by adding a circuit such as PWM (Pulse Width Modulation).
- No adjustment of brightness is possible.

CNB1 pins 4 & 5 are available for connecting to an inverter or circuit where VR control is supported.

CNB1

PIN	DESCRIPTION
4	VR WIP
5	VR A

This can then be matched with function controls (OSD switch mount) pins 3 & 4: see cable design below .

Design Guideline for making VR circuitry :

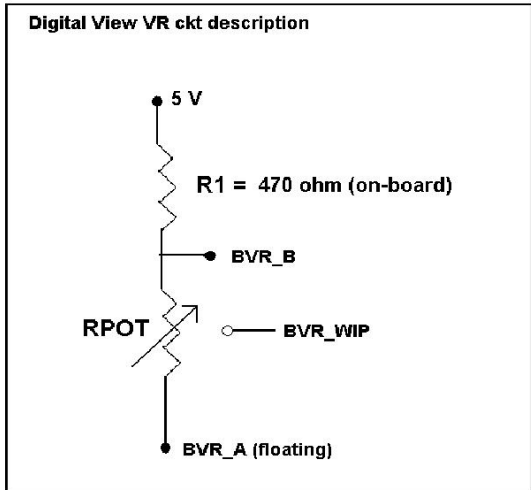

Signal description / Notes :

- 1) R1 : 470ohm on board
- 2) RPOT is an external potentiometer (in-line dip style) that can be plugged directly into CNC1 pins 3,4,5. RPOT must be supplied / installed by user.
- 3) BVR_B : Voltage tapped from “top” of potentiometer, the node of R1 and RPOT.
- 4) BVR_WIP : Voltage tapped from wiper arm of RPOT.
- 5) BVR_A : Voltage tapped from “bottom” of RPOT.

Note : BVR_A voltage is left floating on the controller board. To use this circuit, you need to tie this point to a potential (usually GND, available at CNC1 pin 6).

CNB1 – Backlight inverter connector: JST B5B-XH-A (Matching type : XHP-5)

PIN	SYMBOL	DESCRIPTION
1	GND	Ground
2	VBKL	+12VDC, backlight power supply (selected by JA3 & JA6)
3	BLCTRL	On/Off control (enable) – see JB2 & JB3
4	BVR_WIP	Brightness VR - WIP
5	BVR_A	Brightness VR A

CNC1 – Control switch, JST B12B-XH-A (Matching type : XHP-12)

PIN	SYMBOL	DESCRIPTION
1	PSWIN	Power button A
2	SW_ON	Power button B
3	BVR_A	Backlight Brightness VR pin A
4	BVR_WIP	Backlight Brightness R pin WIP
5	BVR_B	Backlight Brightness VR pin B (470 ohm resistor to +5V Vcc)
6	GND	Ground
7	MENU	OSD menu
8	-/LEFT	OSD -/Left
9	+ /RIGHT	OSD +/Right
10	SEL_DN	OSD Select down
11	SEL_UP	OSD Select up
12	NC	No connection

The VR for brightness depends on the inverter. The main power load for On/Off is handled by a relay on the controller.

Example for circuit design :

- 1.) Choose RPOT = 10K
- 2.) Tie BVR_A to GND
- 3.) Circuit analysis gives BVR_WIP as the following (see Figure 1)

$$BVR_WIP = 5 \times (Rbc/10.47)$$

where BVR_WIP is in Volts.
And Rbc is the resistance from the wiper arm to bottom of pot in Kohms.

To evaluate, plug in different values of Rbc :

Rbc	BVR_WIP
0	0 V
2.5 K	1.2 V
5 K	2.4 V
7.5 K	3.6 V
10 K	4.8 V

So this circuit could provide Brightness adjust voltage ranging from 0V to 5V.

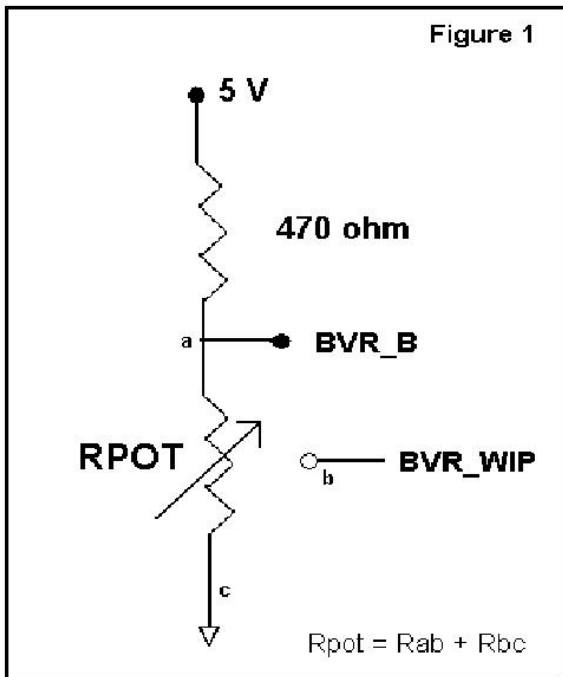

TROUBLESHOOTING

General

A general guide to troubleshooting a flat panel display system it is worth considering the system as separate elements, such as:

- Controller (jumpers, PC settings)
- Panel (controller, cabling, connection, panel, PC settings)
- Backlight (inverter, cabling, backlight tubes)
- Cabling
- Computer system (display settings, operating system)

Through step by step cross checking with instruction manuals and a process of elimination to isolate the problem it is usually possible to clearly identify the problem area.

No image:

- If the panel backlight is not working it may still be possible to just see some image on the display.
- A lack of image is most likely to be caused by incorrect connection, lack of power, failure to provide a signal or incorrect graphic card settings.

Image position:

If it is impossible to position the image correctly, ie the image adjustment controls will not move the image far enough, then test using another graphics card. This situation can occur with a custom graphics card that is not close to standard timings or if something is in the graphics line that may be affecting the signal such as a signal splitter (please note that normally a signal splitter will not have any adverse effect).

Image appearance:

- A faulty panel can have blank lines, failed sections, flickering or flashing display
- Incorrect graphics card refresh rate, resolution or interlaced mode will probably cause the image to be the wrong size, to scroll, flicker badly or possibly even no image.
- Incorrect jumper settings on the controller may cause everything from total failure to incorrect image. CAUTION: Do not set the panel power input incorrectly.
- Sparkling on the display: faulty panel signal cable.

Backlight:

Items to check include: Power input, Controls, Inverter and Tubes generally in this order.

If half the screen is dimmer than the other half:

- Check cabling for the inverter.
- For a specific backlight tube check the AC pins orientation (CAUTION: Never reverse any DC power pins).

Also:

- If adjusting brightness control has no effect the chances are that the VR rating or method of adjusting brightness is not compatible or correctly connected to the inverter.
- If system does not power down when there is a loss of signal

Continued failure:

If unit after unit keeps failing consider and investigate whether you are short circuiting the equipment or doing something else seriously wrong.

Generally after common sense issues have been resolved we recommend step by step substitution of known working parts to isolate the problem.

SPECIFICATIONS

Panel compatibility	1920x1200, 1920x1080, 1680x1050, 1600x1200, 1400x1050, 1440x900, 1366x768, 1280x1024, 1280x800, 1280x768, 1024x768, 1024x600, 800x600, 800x480, 640x480, 480x640 resolution TFT LVDS LCD's support.
No. of colours	Up to 3 x 8 bit providing 16.7 million colours.
Vertical refresh rate	WUXGA, UXGA, WXGA, SXGA, XGA, SVGA, VGA resolution up to 60Hz.
Dot clock (pixel clock) maximum	165 MHz
Graphics formats	Standard WUXGA, UXGA, SXGA, XGA, SVGA, VGA
Standard input at source	- VGA analog (15-pin) standard with automatic detection of : Digital Separate Sync Sync-On-Green Composite Sync - HDMI (v1.3) - Display Port (1.1a) - SDI
Controls available	- On/Off - Brightness (inverter) - OSD menu - OSD select - OSD setting + - OSD setting -
Control interface	- Buttons, RS-232, IR remote control
Settings memory	Settings are stored in non volatile memory
Language OSD support	Graphics OSD icons
VESA DPMS implementation	Yes
Plug & Play	VESA DDC 1, 2/b compatible
Supported SDI serial interface standard	SMPTE 292M, 259M-C, 424M, 425M (Level A)
Supported SDI video mode	576i50 (PAL) 480i60 (NTSC) 720p60/59.94/50 (4:2:2) 1080i60/59.94/50 (4:2:2) 1080p60/50 (4:2:2)
Number of SDI channel input port supported	1
SDI re-clock loop through output	Yes
AFD (Active Format Description) support at SDI port.	Yes
Embedded digital audio	Supported with Stereo
Voltage output for LCD	+3.3V , +5V, +12V The current drawn for 3.3V, 5V or 12V panel from 12VDC power input is limited to 3A.
Input voltage	12VDC , 5A max +/- 5%
Controller power consumption	Approx 9.6W (controller logic only, no panel and inverter are involved)
Controller dimensions	185mm x 93.5mm x 18.3mm
Storage temperature limits	-40°C to +70°C
Operating temperature limits	0°C to +60°C

NOTES

Please note the following:

- For specific panel setup a sample of an LCD may be required (this will be returned) and a copy of the full technical specifications for the panel from the manufacturer.
- Relayout and custom development services are available.

Appendix I – Mode Support Table

ARGB (P1) port :

Mode	Resolution	Clk [MHz]	Horizontal freq [KHz]	Vertical freq [Hz]	Sync Mode
T_70	720x400 70Hz	28.322	31.469	70.087	Digital Separate Sync
T_70	720x400 70Hz	28.322	31.469	70.087	Sync On Green
V_60	640x480 60Hz	25.175	31.469	59.940	Digital Separate Sync
V_60	640x480 60Hz	25.175	31.469	59.940	Sync On Green
V_60	640x480 60Hz	25.175	31.469	59.940	Composite Sync
SV_60	800x600 60Hz	40.000	37.879	60.317	Digital Separate Sync
SV_60	800x600 60Hz	40.000	37.879	60.317	Sync On Green
SV_60	800x600 60Hz	40.000	37.879	60.317	Composite Sync
X_60	1024x768 60Hz	65.000	48.363	60.004	Digital Separate Sync
X_60	1024x768 60Hz	65.000	48.363	60.004	Sync On Green
X_60	1024x768 60Hz	65.000	48.363	60.004	Composite Sync
SX_60	1280x1024 60Hz	108	63.81	60.020	Digital Separate Sync
SX_60	1280x1024 60Hz	108	63.81	60.020	Sync On Green
SX_60	1280x1024 60Hz	108	63.81	60.020	Composite Sync
UX_60	1600x1200 60Hz	162	75.000	60	Digital Separate Sync
UX_60	1600x1200 60Hz	162	75.000	60	Sync On Green
UX_60	1600x1200 60Hz	162	75.000	60	Composite Sync
WUX_60	1920x1080 60Hz	172.8	67.5	60	Digital Separate Sync
WUX_60	1920x1080 60Hz	172.8	67.5	60	Sync On Green
WUX_60	1920x1080 60Hz	172.8	67.5	60	Composite Sync
WUX_60	1920x1200 60Hz	193.2	74.5	60	Digital Separate Sync
WUX_60	1920x1200 60Hz	193.2	74.5	60	Sync On Green
WUX_60	1920x1200 60Hz	193.2	74.5	60	Composite Sync

HDMI (P3) port :

Mode	Resolution	Clk [MHz]	Horizontal freq [KHz]	Vertical freq [Hz]
T_70	720x400 70Hz	28.322	31.469	70.087
V_60	640x480 60Hz	25.175	31.469	59.940
SV_60	800x600 60Hz	40.000	37.879	60.317
X_60	1024x768 60Hz	65.000	48.363	60.004
SX_60	1280x1024 60Hz	108	63.81	60.020
UX_60	1600x1200 60Hz	162	75.000	60
WUX_60	1920x1080 60Hz	172.8	67.5	60
WUX_60	1920x1200 60Hz	193.2	74.5	60
1080p60	1920x1080p 60Hz	135	67.5	60
1080i60	1920x1080i 60Hz	74.14	33.7	60
1080i50	1920x1080i 50Hz	74.184	28.1	50
720p60	1280x720P 60Hz	74.25	45	60
576p50	720x576P 50Hz	26.9568	31.2	50
480p60	720x480P 60Hz	26.9568	31.4	60

Display Port (P4) port :

Mode	Resolution	Clk [MHz]	Horizontal freq [KHz]	Vertical freq [Hz]
T_70	720x400 70Hz	28.322	31.469	70.087
V_60	640x480 60Hz	25.175	31.469	59.940
SV_60	800x600 60Hz	40.000	37.879	60.317
X_60	1024x768 60Hz	65.000	48.363	60.004
SX_60	1280x1024 60Hz	108	63.81	60.020
UX_60	1600x1200 60Hz	162	75.000	60
WUX_60	1920x1080 60Hz	172.8	67.5	60
WUX_60	1920x1200 60Hz	193.2	74.5	60
1080p60	1920x1080p 60Hz	135	67.5	60
1080i60	1920x1080i 60Hz	74.14	33.7	60
1080i50	1920x1080i 50Hz	74.184	28.1	50
720p60	1280x720P 60Hz	74.25	45	60
576p50	720x576P 50Hz	26.9568	31.2	50
480p60	720x480P 60Hz	26.9568	31.4	60

SDI (J2) port

Mode
576i50 (PAL)
480i60 (NTSC)
720p60 (4:2:2)
720p59.94 (4:2:2)
720p50 (4:2:2)
1080i60 (4:2:2)
1080i59.94 (4:2:2)
1080i50 (4:2:2)
1080p60 (4:2:2)
1080p50 (4:2:2)

Appendix II – RS-232 control protocols

RS-232 Serial control (Baud rate 2400, 8 bits, 1 stop bit and no parity)

Physical connection :

Controller side
Connector interface : CN7
Mating connector : DB9 Female

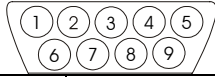

Mating face of RS-232 DB9 Female

PIN#	Description
2	RS-232 Tx Data
3	RS-232 Rx Data
5	Ground

Computer side
Connector interface : Serial port
Mating connector : DB9 Male

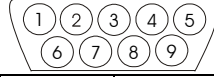

Mating face of RS-232 DB9 Male

PIN#	Description
2	RS-232 Rx Data
3	RS-232 Tx Data
5	Ground

Software connection :

The OSD function can be controlled through sending the RS-232 protocol.

The RS-232 program can be custom-made to fit for application or it can be used the program provided by Digitalview on request. Please contact your local sales for informations.

1. Commands to implement switch mount control buttons

Function	Command	Description	Acknowledge (if enabled)
Menu	0xf7	Menu button pressed	Button equivalent
Select-down button	0xfa	Select down button pressed	Button equivalent
Select-up button	0xfb	Select up button pressed	Button equivalent
Right/+ button	0xfc	Right/+button pressed	Button equivalent
Left/- button	0xfd	Left/- button pressed	Button equivalent

2. Parameter setting - immediate, relative, reset and query

Function	Command	Description	Acknowledge (if enabled)
Volume control - left + right channel	0x80, "a" "A", nn "+" "-" "r" "R" "?"	Set audio (L+R) volume = value/increment/decrement Reset Query	Volume left + right
Volume control - on/off (mute)	0x80, "m" "M", "0" "1" "r" "R" "?"	Disable audio output Enable audio output Reset Query	"0" – audio off (muted) "1" – audio on
Brightness control	0x81, nn "+" "-" "r" "R" "?"	Set brightness = value/increment/decrement Reset Query	Brightness. Range: "0""0"- "6""4" Default: "3""2"
Contrast control	0x82, "a" "A", nn "+" "-" "r" "R" "?"	Set all contrast = value/increment/decrement Reset Query	Contrast. Range: "4""0"- "6""4" Default: "3""2"
Phase #	0x85, nn "+" "-" "?"	Set dot clock phase = value/increment/decrement Query	Dot clock phase. (In ARGB mode only)
Image H position #	0x86, nnnn "+" "-" "?"	Set img_hpos = value/increment/decrement Query	Image horizontal position. (In ARGB mode only)
Image V position #	0x87, nnnn "+" "-" "?"	Set img_vpos = value/increment/decrement Query	Image vertical position. (In ARGB mode only)
Sharpness	0x8a, nn "+" "-" "r" "R" "?"	Set sharpness= value/increment/decrement Reset Query	Sharpness Range: "F""C"- "0""4" Default: "0""0"
Frequency #	0x8b,	Frequency =	Frequency adjustment

	nnnn "+" "-" "?"	value/increment/decrement Query	(In ARGB mode only)
OSD H position	0x90, nnn "+" "-" "r" "R" "?"	Set osd_hpos = value/increment/decrement Reset Query	OSD horizontal position Range: "0"0"0"- "3"E"8" Default: "1"F"4"
OSD V position	0x91, nnn "+" "-" "r" "R" "?"	Set osd_vpos = value/increment/decrement Reset Query	OSD vertical position Range: "0"0"0"- "3"E"8" Default: "1"F"4"
Select menu timeout	0x93, nn "+" "-" "r" "R" "?"	Select menu timeout = value/increment/decrement Reset Query	OSD menu timeout value. "00" – Continuous. Value – Round up to nearest available step. If value > max available step, set it to the max available step. "0" "0" – Always On. "0" "C" – 12 seconds (Default) "0" "6" – 6 seconds "0" "3" – 3 seconds
Input main select * Function in Valid mode only	0x98, nn "+" "-" "r" "R" "?"	Select input main = PC or video or next available Reset Query	Main selected. "0x41,0x31" ARGB (Default) "0x45,0x31" HDSDDI "0x48,0x31" HDMI "0x50,0x31" Display Port
GAMMA value select	0x9d, n "r" "R" "?"	Select GAMMA value = Value Reset Query	GAMMA value: "0" – 0.4, "1" – 0.6 "2" – 1.0 (Default), "3" – 1.6 "4" – 2.2
Colour temperature select	0xb3, n "r" "R" "?"	Select colour temperature = value Reset Query	Main selected. "0" – user defined RGB values. "1" – 4200K. "2" – 5000K. "3" – 6500K. "4" – 7500K. (Default) "5" – 9300K.
Red level for selected colour temperature	0xb4, nn "+" "-" "r" "R" "?"	Set the level of the red channel for the selected colour temp. = value/increment/decrement Reset Query	Red level for selected colour temperature. Range: "0"0"0"- "6"4" Default: "6"4"
Green level for selected colour temperature	0xb5, nn "+" "-" "r" "R" "?"	Set the level of the green channel for the selected colour temp. = value/increment/decrement Reset Query	Green level for selected colour temperature. Range: "0"0"0"- "6"4" Default: "6"4"
Blue level for selected colour temperature	0xb6, nn "+" "-" "r" "R" "?"	Set the level of the blue channel for the selected colour temp. = value/increment/decrement Reset Query	Blue level for selected colour temperature. Range: "0"0"0"- "6"4" Default: "6"4"
Backlight brightness control	0xe0, nn "+" "-" "r" "R" "?"	Set backlight brightness = value/increment/decrement Reset Query	Backlight brightness. Range: "0"0"0"- "F"F" Default: "F"F" e.g "1"0" → 0xe0 0x31 0x30 * This control can only function when JB5 sets 3-4 closed

			* Apply for inverter control voltage in range of 0~5V. Each step interval is in 1
Backlight on/off control	0xe1, "0" "1" "r" "R" "?"	Set backlight brightness = Disable backlight Enable backlight Reset Query	Backlight on/off.
OSD menu lock	0xf6, n "0" "1" "r" "R" "?"	OSD menu lock Off/ On Reset Query	"0" – OSD menu lock Off "1" – OSD menu lock On

- Function in ARGB mode only

3. Other control

Function	Command	Description	Acknowledge (if enabled)
Select RS-232 acknowledge	0xc1, "0" "1"	Disable/enable command acknowledge.	"0" – acknowledge disabled. "1" – acknowledge enabled.
Auto-setup #	0xc3	Start auto-setup of current vmode.	"0" – fail. "1" – successful.
Command availability	0xc4, n	Check whether a command is available.	"0" – not available. "1" – available.
Auto-calibration #	0xc5	Start auto-calibration of gain of the RGB amplifier.	"0" – fail. "1" – successful.
Query BIOS version	0xcb, "0"	Read BIOS version	"nnnn" = BIOS ver. "nn.nn"
Query PCBA number	0xcb, "1"	Read PCBA number	"nnnn" = PCBA number ALR-1920-SDI="41728"
Load factory defaults	0xce	Reset all parameters to factory default value	"1" – successful.

- Function in ARGB mode only

Hex to ASCII conversion table

Hex	ASCII	Hex	ASCII	Hex	ASCII	Hex	ASCII
0x30	0	0x41	A	0x61	a	0x2B	+
0x31	1	0x42	B	0x62	b	0x2D	-
0x32	2	0x43	C	0x63	c	0x3F	?
0x33	3	0x44	D	0x64	d		
0x34	4	0x45	E	0x65	e		
0x35	5	0x46	F	0x66	f		
0x36	6	0x47	G	0x67	g		
0x37	7	0x48	H	0x68	h		
0x38	8	0x49	I	0x69	i		
0x39	9	0x4A	J	0x6A	j		
		0x4B	K	0x6B	k		
		0x4C	L	0x6C	l		
		0x4D	M	0x6D	m		
		0x4E	N	0x6E	n		
		0x4F	O	0x6F	o		
		0x50	P	0x70	p		
		0x51	Q	0x71	q		
		0x52	R	0x72	r		
		0x53	S	0x73	s		
		0x54	T	0x74	t		
		0x55	U	0x75	u		
		0x56	V	0x76	v		
		0x57	W	0x77	w		
		0x58	X	0x78	x		
		0x59	Y	0x79	y		
		0x5A	Z	0x7A	z		

Appendix III – Mapping definition

- Definition of Mapping A :

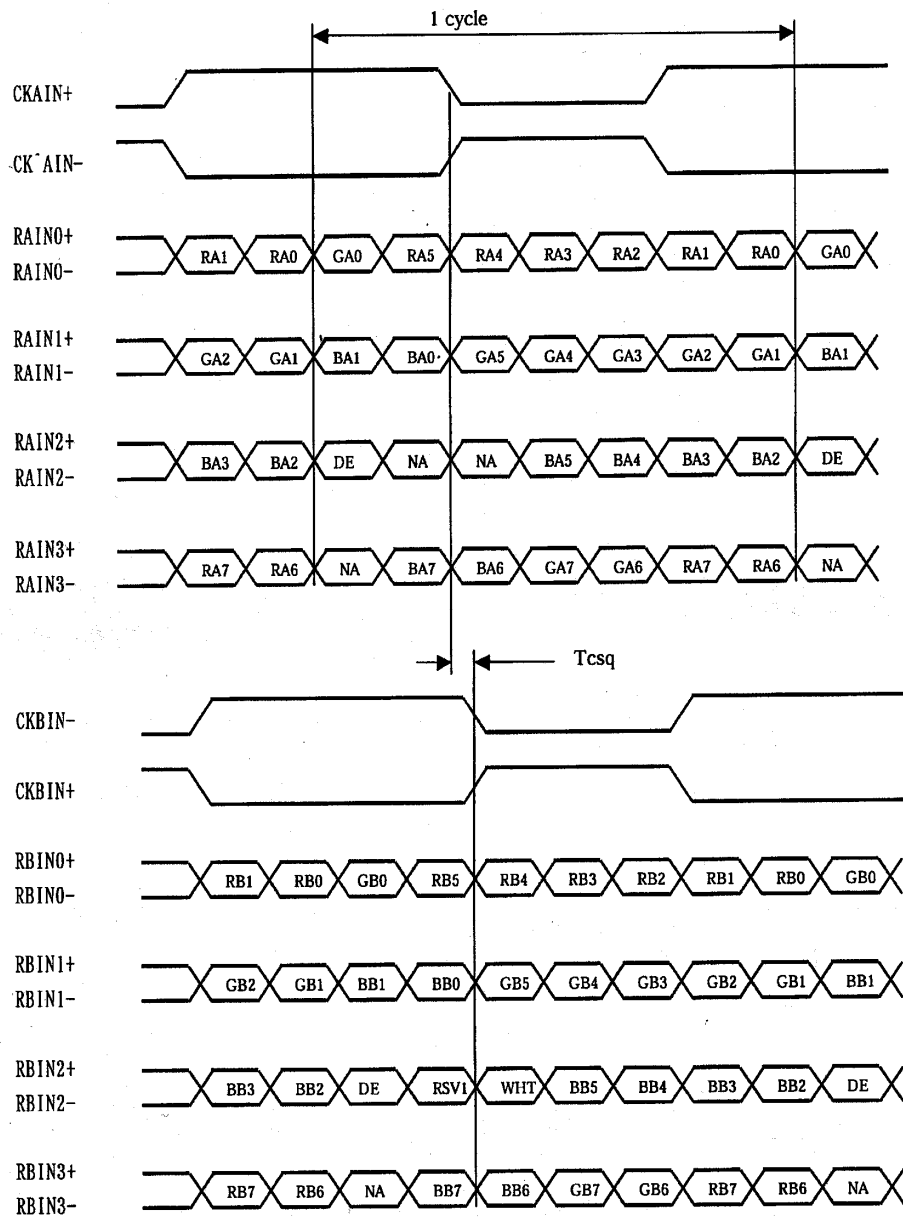

- Definition of Mapping B :

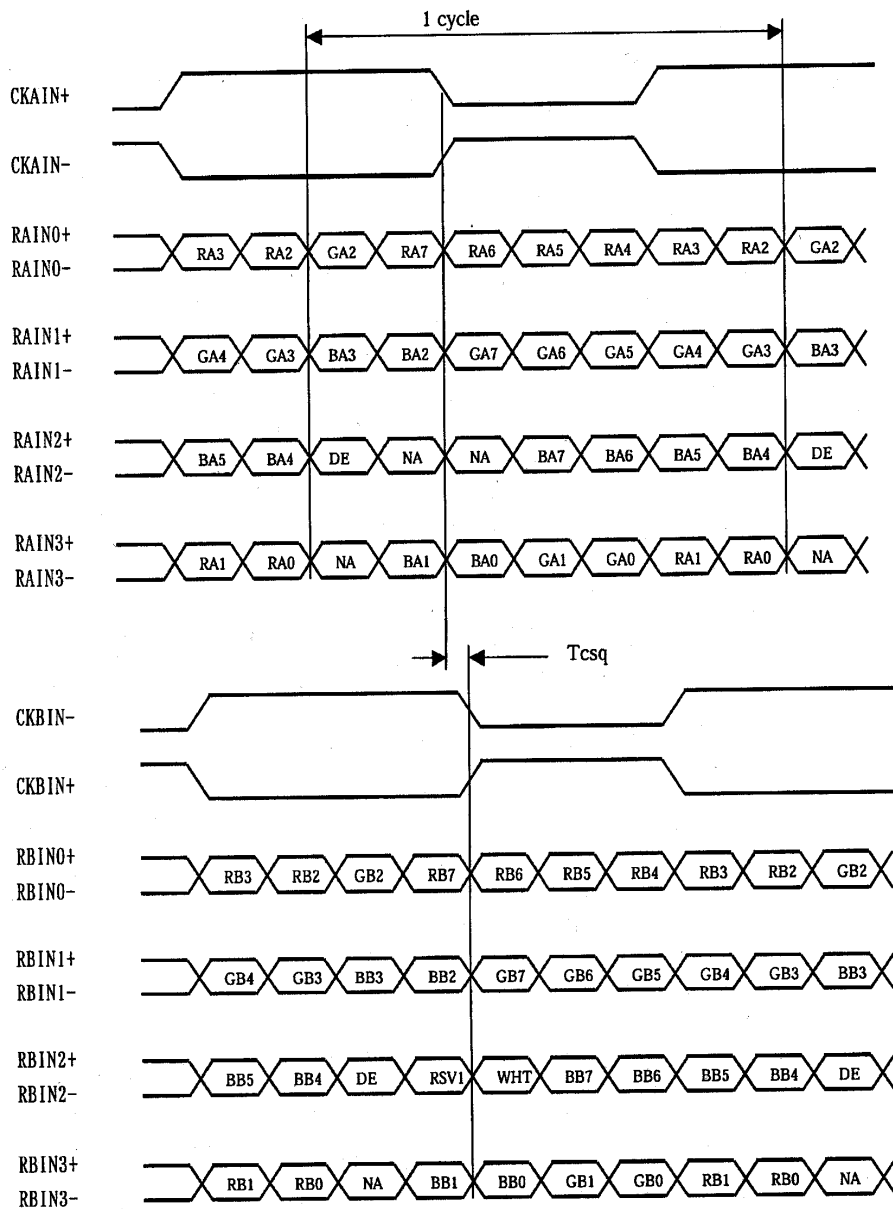

Appendix IV – Auto Color Gain

The Auto Color Gain function is supported in the ARGB mode only and is designed to calibrate the controller to the incoming video signal. In order to calibrate correctly, the display must be displaying an image containing both black and white data (see illustration below) when the function is used. The internal processor of the video controller chip will then execute a process to adjust the relative values of the RGB signals to achieve the best performance. The parameters of the corrected RGB values are then stored in the controller and are unaffected by the Reset Factory Defaults function.



Warning - If the Auto Color Gain is executed without an appropriate image being displayed, then the process will set incorrect values and the display colors will be distorted. If this occurs, then it can either be corrected by performing the process correctly or if this is not possible then the Reset Color Gain function can be used. This function will reset the stored RGB values to a set of approximate values.

Appendix V – DV remote control unit work for ALR-1920-SDI

P/N 559000106-3 :
DigitalView remote control unit
(without DV logo silk screen
printing)

P/N 559000105-3 :
DigitalView remote control unit
(with DigitalView logo silk
screen printing)



BUTTON	FUNCTION
POWER BUTTON	Soft power ON/OFF button.
ATTENTION BUTTON	Use combined with digit keys to enable/disable the IR function. ALR-1920-SDI : "Attention" + "1"
MUTE BUTTON (MUTE)	Switch to mute on/off mode.
SEL UP (▲) / SEL DN (▼)	Press this button to select the items in the OSD menu.
VOLUME (-/+) BUTTON	Press the "+" button to increase the volume and the "-" to decrease the volume.
+ / - BUTTON	Use "+" button to direct control the hotkey function for switching to next input source. In OSD menu, pressing this button to adjust the settings.
DISPLAY BUTTON	Activate the OSD menu display on screen.
STOP (VGA) BUTTON	Press this button in the non OSD menu display mode to select VGA source.
HDMI BUTTON	Press this button in the non OSD menu display mode to select DVI source.
HD-SDI 1 BUTTON	Press this button in the non OSD menu display mode to select SDI source.

WARRANTY

The products are warranted against defects in workmanship and material for a period of three (3) year from the date of purchase provided no modifications are made to it and it is operated under normal conditions and in compliance with the instruction manual.

The warranty does not apply to:

- Product that has been installed incorrectly, this specifically includes but is not limited to cases where electrical short circuit is caused.
- Product that has been altered or repaired except by the manufacturer (or with the manufacturer's consent).
- Product that has subjected to misuse, accidents, abuse, negligence or unusual stress whether physical or electrical.
- Ordinary wear and tear.

Except for the above express warranties, the manufacturer disclaims all warranties on products furnished hereunder, including all implied warranties of merchantability and fitness for a particular application or purpose. The stated express warranties are in lieu of all obligations or liabilities on the part of the manufacturer for damages, including but not limited to special, indirect consequential damages arising out of or in connection with the use of or performance of the products.

CAUTION

Whilst care has been taken to provide as much detail as possible for use of this product it cannot be relied upon as an exhaustive source of information. This product is for use by suitably qualified persons who understand the nature of the work they are doing and are able to take suitable precautions and design and produce a product that is safe and meets regulatory requirements.

LIMITATION OF LIABILITY

The manufacturer's liability for damages to customer or others resulting from the use of any product supplied hereunder shall in no event exceed the purchase price of said product.

TRADEMARKS

The following are trademarks of Digital View Ltd:

- Digital View
- ALR-1920-SDI

CONTACT DETAILS

Digital View has offices in Asia, Europe and USA also an internet site:

ASIA

Digital View Ltd
16th Floor Millennium City 3
370 Kwun Tong Road
Kwun Tong
Hong Kong

Tel: (852) 2861 3615

Fax: (852) 2520 2987

Sales: hksales@digitalview.com

EUROPE

Digital View Ltd.
6 Marylebone Passage,
London, W1W 8EX
UK

Tel: +44-(0)20-7631-2150

Fax: +44-(0)20-7631-2156

Sales: uksales@digitalview.com

USA

Digital View Inc.
18440 Technology Drive
Building 130
Morgan Hill,
California, 95037
USA

Tel: (1) 408-782 7773

Fax: (1) 408-782 7883

Sales: ussales@digitalview.com

WEBSITE

www.digitalview.com

Specifications subject to change without notice
3rd issue: 15 March, 2013 (ALR-1920-SDI.doc)

© Digital View Ltd 2011-2013