

PLEASE CHECK WWW.MOLEX.COM FOR LATEST PART INFORMATION

Part Number: [0752374114](#)
Status: **Active**
Overview: [gbx_backplane_connector_system](#)
Description: 1.85mm by 1.85mm (.073 by .073") Pitch 5-Pair GbX® Backplane Connector System, Right Guide Header, 100 Circuits, Gold (Au) 0.76µm (30µ"), Pin Length 4.55mm (.179")

Documents:

[Drawing \(PDF\)](#) [RoHS Certificate of Compliance \(PDF\)](#)
[Product Specification PS-75221-999 \(PDF\)](#)

Agency Certification

UL E29179

General

Product Family Backplane Connectors
 Series [75237](#)
 Application Backplane
 Application Tooling Documents [Tooling Manual](http://www.molex.com/pdm_docs/ats/TM-622022099.pdf)
 Comments Right Guide Header, Keying Position A
 Component Type PCB Header
 Overview [gbx_backplane_connector_system](#)
 Product Name GbX®
 Style N/A

Physical

Circuits (Loaded) 100
 Circuits (maximum) 100
 Color - Resin Gray (Dark)
 Durability (mating cycles max) 200
 First Mate / Last Break No
 Flammability 94V-0
 Guide to Mating Part Yes
 Keying to Mating Part Yes
 Material - Metal High Performance Alloy (HPA), Stainless Steel
 Material - Plating Mating Gold
 Material - Plating Termination Tin-Lead
 Material - Resin High Temperature Thermoplastic
 Number of Columns 10
 Number of Pairs 5
 Number of Rows 10
 Orientation Vertical
 PC Tail Length (in) 0.091 In
 PC Tail Length (mm) 2.30 mm
 PCB Locator No
 PCB Retention Yes
 PCB Thickness Recommended (in) 0.063 In
 PCB Thickness Recommended (mm) 1.60 mm
 Packaging Type Tray
 Pitch - Mating Interface (in) 0.073 In
 Pitch - Mating Interface (mm) 1.85 mm
 Pitch - Term. Interface (in) 0.073 In
 Pitch - Term. Interface (mm) 1.85 mm
 Plating min: Mating (µin) 30
 Plating min: Mating (µm) 0.76
 Plating min: Termination (µin) 30

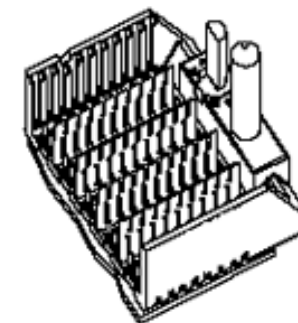

image - Reference only

Series

EU RoHS

RoHS Compliant by Exemption

REACH SVHC

Not Reviewed

Halogen-Free

Status

Not Reviewed

China RoHS



Need more information on product environmental compliance?

Email productcompliance@molex.com
 For a multiple part number RoHS Certificate of Compliance, [click here](#)

Please visit the [Contact Us](#) section for any non-product compliance questions.

Search Parts in this Series

[75237Series](#)

Mates With

[75360 GbX® Daughtercard](#)

Application Tooling | FAQ

Tooling specifications and manuals are found by selecting the products below. Crimp Height Specifications are then contained in the Application Tooling Specification document.

Global

Description	Product #
Insertion Tool, GbX®	0622022030
5 pair by 10 wide	
Insertion Tool, GbX®	0622022040
5 pair by 20 wide	
GbX® Single Pin	0622022090
Repair Tool	
GbX® Shield	0622022100
Removal Tool	

Plating min: Termination (µm)	0.76
Polarized to PCB	No
Stackable	No
Surface Mount Compatible (SMC)	Yes
Temperature Range - Operating	105°C
Termination Interface: Style	Through Hole - Compliant Pin

Electrical

Current - Maximum per Contact	1A
Data Rate	8.0 Gbps
Real Signals (per 25mm)	135
Shield Type	Ground Plane Shield
Shielded	Yes
Voltage - Maximum	120V AC (RMS)/DC

Material Info

Reference - Drawing Numbers

Product Specification	PS-75221-999
Sales Drawing	SD-75237-410

GbX is a registered trademark of Amphenol Corporation.

This document was generated on 05/13/2010

PLEASE CHECK WWW.MOLEX.COM FOR LATEST PART INFORMATION

20 19 18 17 16 15 14 13 12 11 75237 9 8 7 6 5 4 3 2 1

L
K
J
I
H
G
F
E
D
C
B
A

L
K
J
I
H
G
F
E
D
C
B
A

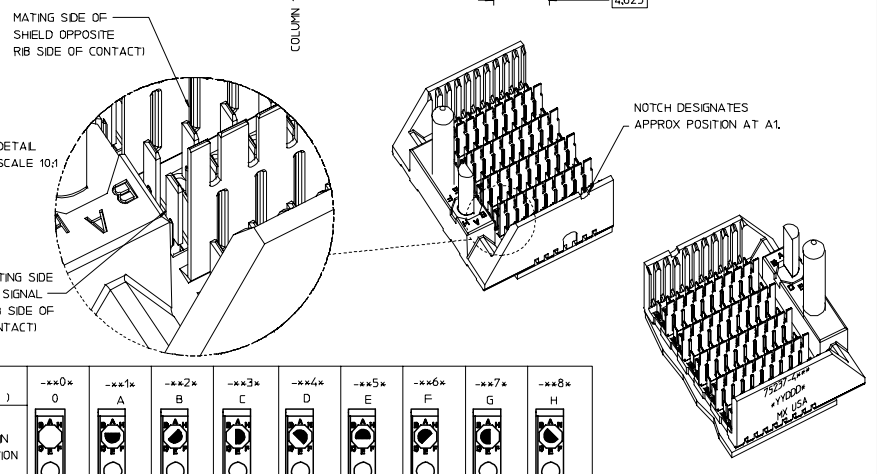
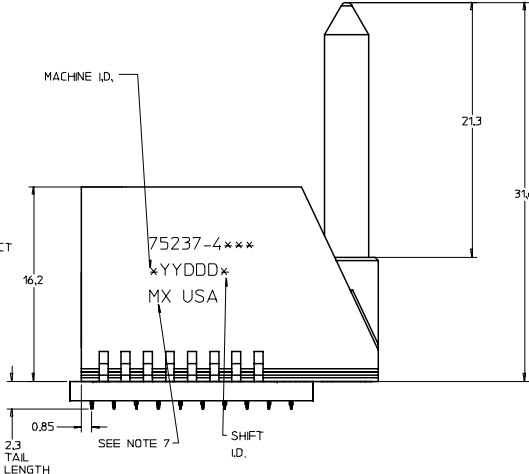
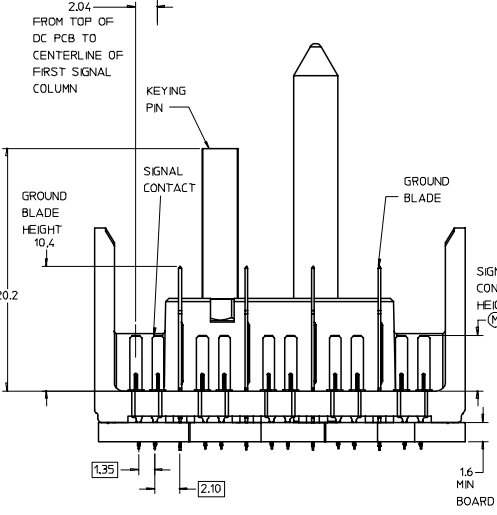
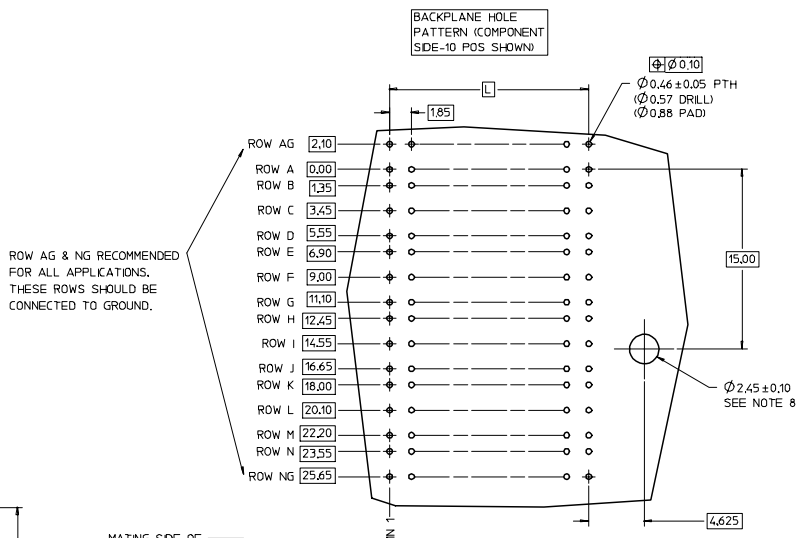
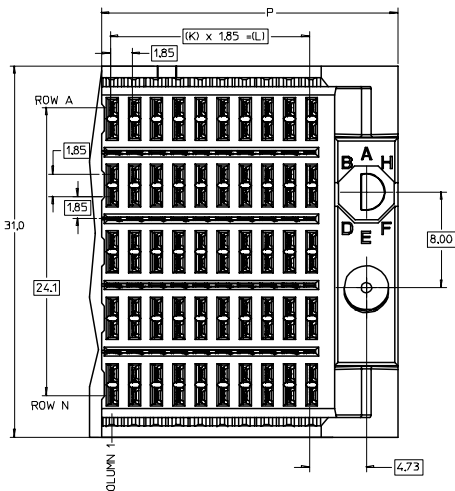
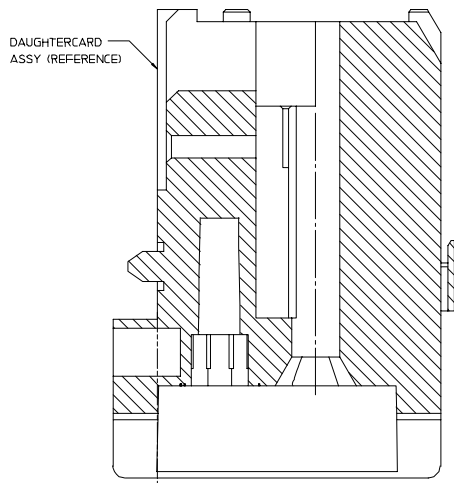

- NOTES:
1. MATERIAL: HOUSING - LIQUID CRYSTAL POLYMER (LCP) GLASS-FILLED, UL 94V-0, COLOR - GRAY. SIGNAL CONTACT AND GROUND BLADE - HIGH PERFORMANCE COPPER ALLOY.
 2. FINISHES: SELECTIVE GOLD (Au) ON CONTACT AREA, SELECTIVE TIN/LEAD (Sn/Pb) ON PCB TAILS, NICKEL (Ni) OVERALL.
 3. THIS PART CONFORMS TO MOLEX PRODUCT SPECIFICATION PS-75221-999.
 4. FOR MIXED CONTACT MATING LENGTHS CONSULT MOLEX FOR AVAILABILITY. CONTACT PAIRS MUST BE THE SAME LENGTH.
 5. FOR SPECIFIC PART NUMBER AND MATING INFORMATION PLEASE REFER TO CHART.
 6. PACKAGE PER PK-70873-565.
 7. EITHER MARK PART NUMBER AND DATE CODE APPROXIMATELY WHERE SHOWN, ON EITHER SIDE OF THE PART, OR PLACE A LABEL ON THE TUBE.
 8. OPTIONAL HOLE LOCATION FOR GROUNDED GUIDE PIN OR ADDITIONAL GUIDE PIN SUPPORT. FOR GROUNDED GUIDE PIN, HOLE TO BE PLATED, DRILL SIZE Ø2.58, PAD SIZE Ø5.50
 9. THESE PARTS CONFORM TO MOLEX COSMETIC SPECIFICATION PS-45499-002 CLASS B.

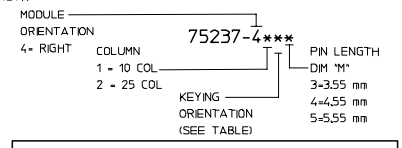

PART NUMBER TABLE				
ASSY PART NO.	K	L	P	TOTAL NO. OF DIFFERENTIAL PAIRS
75237-41**	9	16.65	24.78	50
75237-42**	24	44.40	52.53	125

P/N	-**0*	-**1*	-**2*	-**3*	-**4*	-**5*	-**6*	-**7*	-**8*
75237-()	0	A	B	C	D	E	F	G	H
KEYING PIN ORIENTATION									

REVISED EC NO: UCP2007-2827 DRWN: JINGHAM 2007/05/10 CHKD: CHYK 2007/05/15 APPR: SREED 2007/05/15	QUALITY SYMBOLS	GENERAL TOLERANCES (UNLESS SPECIFIED)	SCALE 5:1	DESIGN UNITS METRIC	THIRD ANGLE PROJECTION	REVISE ON CAD ONLY
	0	4 PLACES ±--- 3 PLACES ±--- 2 PLACES ±--- 1 PLACE ±---	mm INCH	DIMENSION STYLE MM ONLY	TITLE	
	1	ANGULAR ±---°		DRAWN BY DATE NMARTIN 2004/03/16	GBX 5-PAIR RIGHT END BACKPLANE SALES ASSEMBLY	
	2	DRAFT WHERE APPLICABLE MUST REMAIN WITHIN DIMENSIONS		CHECKED BY DATE SREED 2004/03/16	MOLEX INCORPORATED	
			APPROVED BY DATE CBIXLER 2004/03/16	MATERIAL NO. DOCUMENT NO.	SD-75237-410	
			THIS DRAWING CONTAINS INFORMATION THAT IS PROPRIETARY TO MOLEX INCORPORATED AND SHOULD NOT BE USED WITHOUT WRITTEN PERMISSION			
					SHEET NO. 1 OF 1	

19 18 17 16 15 14 13 12 11 10 9 8 7 6 5 4 3 2 1