

## System LED Drivers for Mobile phones

# 6LEDs Illumination



BD2802GU

No.11041EAT12

### ●Description

The BD2802GU is a RGB LED driver specifically engineered for decoration purposes. This RGB driver incorporates lighting patterns and illuminates without imposing any load on CPU. This RGB driver is best-suited for illumination using RGB LEDs and decoration using monochrome LEDs. In addition, this RGB driver has been successfully miniaturized through the use of a VCSP85H2 (2.8 mm 0.5 mm pitch) chip size package.

### ●Features

- 1) RGB LED driver (dual drivers)
  - A slope control function is incorporated (allowing dual drivers to be controlled independently).
  - Slope control can be implemented using the DC current.
  - Two modes "continuous illumination mode" and "illumination single cycle mode" are supported.
  - Independent external ON/OFF synchronizing terminals (of dual drivers) are provided.
  - Multiple drivers can be used concurrently by using the I<sup>2</sup>C address change function and supporting reference clock I/O.
- 2) Thermal shutdown
- 3) I<sup>2</sup>C BUS fast mode support (maximum rate: 400 kHz)
  - A device address can be changed via an external pin.

- \* This driver has not been designed for anti-radiation.
- \* This document may be altered without prior notice.
- \* This document does not provide for delivery.

### ●Absolute Maximum Ratings(Ta=25°C)

Parameter	Symbol	Limits	Unit
Maximum Applied voltage	VMAX	7	V
Power Dissipation	Pd	1250 <sup>(Note1)</sup>	mW
Operating Temperature Range	Topr	-40 ~ +85	°C
Storage Temperature Range	Tstg	-55 ~ +150	°C

(Note1) Power dissipation degrading is 10.0mW/°C, when it's used in over 25°C.  
(It's degrading is on the board that is ROHM's standard)

### ●Recommended Operating Conditions(VBAT ≥ VIO, Ta=-40~85°C)

Parameter	Symbol	Limits	Unit
VBAT input voltage	VBAT	2.7 ~ 5.5	V
VIO pin voltage	VIO	1.65 ~ 3.3	V

●Electrical Characteristics(Unless otherwise specified, Ta=25°C, VBAT=3.6V, VIO=1.8V)

Parameter	Symbol	Limits			Unit	Condition
		Min.	Typ.	Max.		
<b>【Circuit Current】</b>						
VBAT Circuit current 1	IBAT1	-	0.1	3.0	μA	RESETB=0V, VIO =0V
VBAT Circuit current 2	IBAT2	-	0.5	3.0	μA	RESETB=0V, VIO=1.8V
VBAT Circuit current 3	IBAT3	-	0.8	1.2	mA	LED 6Ch ON, ILED=10mA setting Exclusive of LED current, RGBISET =120kΩ
<b>【LED Driver】</b>						
LED current Step	ILEDSTP	128			step	RGB1 group, RGB2 group
LED Maximum setup curren	IMAX	-	-	30.48	mA	RGB1 group, RGB2 group RGBISET=100kΩ
LED current accurate	ILED	18	20	22	mA	RGB1 group, RGB2 group, Terminal voltage =1V ILED=20mA setting, RGBISET =120kΩ
LED current Matching	ILEDMT	-	5	10	%	RGB1 group, between RGB2 group, Terminal voltage =1V ILED=20mA setting
LED OFF Leak current	ILKL	-	-	1.0	μA	
<b>【OSC】</b>						
OSC oscillation frequency	fosc	0.8	1.0	1.2	MHz	
<b>【SDA, SCL】 (I2C interface )</b>						
L level input voltage	VILI	-0.3	-	0.25×VIO	V	
H level input voltage	VIHI	0.75×VIO	-	VBAT+0.3	V	
Hysteresis of Schmitt trigger input	Vhysl	0.05×VIO	-	-	V	
L level output voltage	VOLI	0	-	0.3	V	SDA pin, IOL=3 mA
Input current	linl	-10	-	10	μA	Input voltage = 0.1×VIO~0.9×VIO
<b>【RESETB】 (CMOS input pin)</b>						
L level input voltage	VILR	-0.3	-	0.25×VIO	V	
H level input voltage	VIHR	0.75×VIO	-	VBAT+0.3	V	
Input current	linR	-10	-	10	μA	Input voltage = 0.1×VIO~0.9×VIO
<b>【ADDSEL】 (CMOS input pin)</b>						
L level input voltage	VILADD	-0.3	-	0.25×VBAT	V	
H level input voltage	VIHADD	0.7 ×VBAT	-	VBAT+0.3	V	
Input current	linADD	-10	-	10	μA	Input voltage = 0.1×VBAT~0.9×VBAT
<b>【RGB1CNT, RGB2CNT】 (CMOS input pin with Pull-down resistance)</b>						
L level input voltage	VILCNT	-0.3	-	0.25×VIO	V	
H level input voltage	VIHCNT	0.75×VIO	-	VBAT+0.3	V	
Input current	linCNT	-	3.6	10	μA	Input voltage = 1.8V
<b>【CLKIO(Output)】 (CMOS output pin)</b>						
L level output voltage	VOLCLK	-	-	0.2	V	IOL=1mA
H level output voltage	VOHCLK	VIO-0.2	-	-	V	IOH=1mA
Output frequency	fclk	200	250	300	kHz	
<b>【CLKIO (Input)】 (CMOS input pin)</b>						
L level input voltage	VILCLK	-0.3	-	0.25×VIO	V	
H level input voltage	VIHCLK	0.75×VIO	-	VIO+0.3	V	
Input current	linCLK	-	3.6	10	μA	Input voltage = 1.8V

●Block Diagram / Application Circuit example

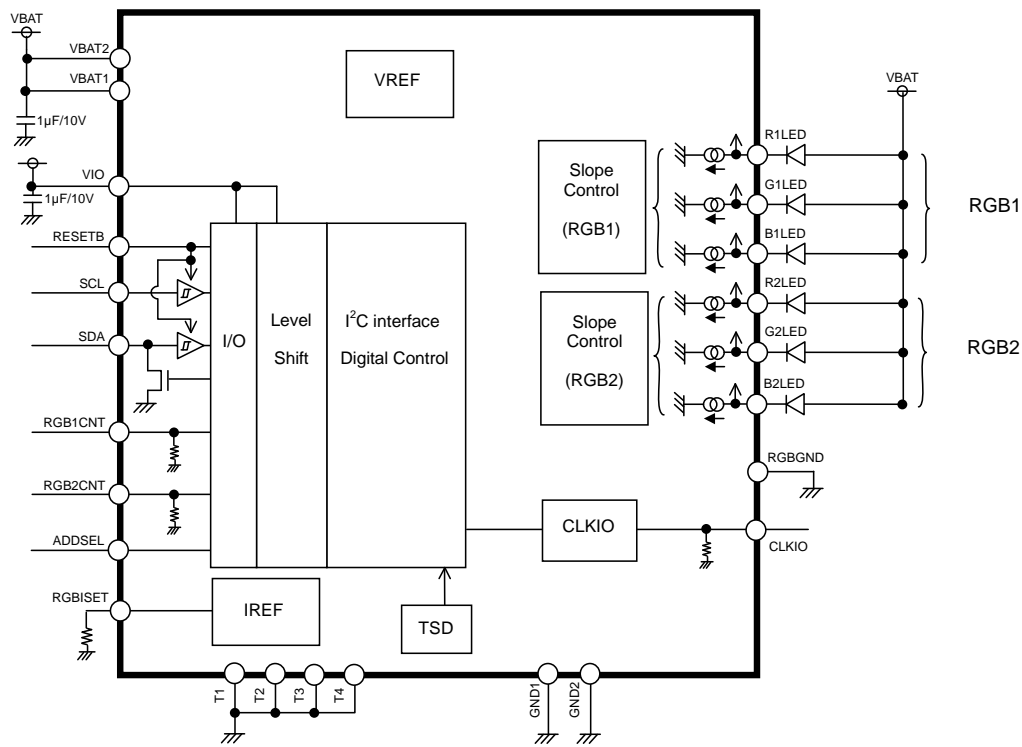

Fig.3 Block Diagram / Application Circuit example

●Pin Arrangement [Bottom View]

E	T4	G2LED	RGBGND	G1LED	T3
D	B2LED	R2LED	B1LED	R1LED	VBAT1
C	VBAT2	RGBISE	RGB1CNT	ADDSEL	GND2
B	GND1	index	CLKIO	SCL	SDA
A	T1	RGB2CNT	VIO	RESETB	T2
	1	2	3	4	5

●Outside size figure

VCSP85H2 CSP small Package

Size : 2.8mm×2.8mm (Tolerance : ± 0.1mm each side) height 1.0mm max

Ball pitch : 0.5 mm

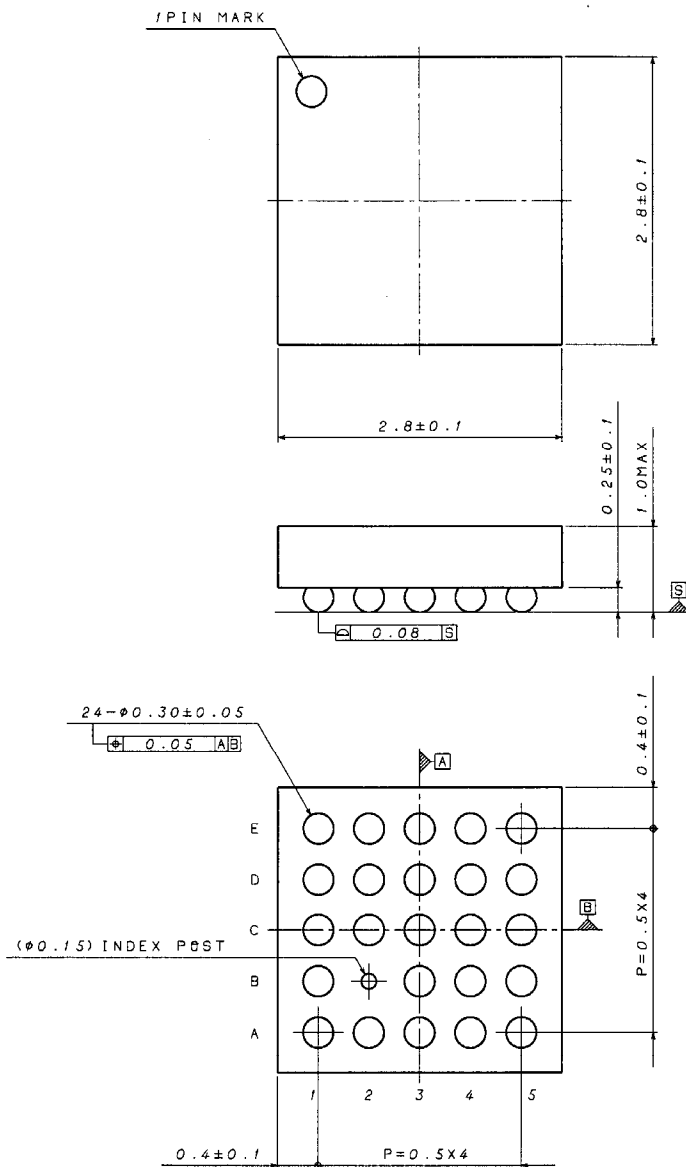

(UNIT : mm)

## ● Pin Functions

No	Pin No.	Pin Name	I/O	Input Level		ESD Diode	Functions
				For Power	For GND		
1	D5	VBAT1	-	-	GND	Battery is connected	A
2	C1	VBAT2	-	-	GND	Battery is connected	A
3	A1	T1	-	VBAT	GND	Test Pin (short to GND)	S
4	A5	T2	-	VBAT	GND	Test Pin (short to GND)	S
5	E5	T3	-	VBAT	GND	Test Pin (short to GND)	S
6	E1	T4	-	VBAT	-	Test Pin (short to GND)	B
7	A3	VIO	-	VBAT	GND	I/O voltage source is connected	C
8	A4	RESETB	I	VBAT	GND	Reset input (L: RESET, H: RESET cancel)	H
9	B5	SDA	I/O	VBAT	GND	I <sup>2</sup> C data input	I
10	B4	SCL	I	VBAT	GND	I <sup>2</sup> C clock input	H
11	B1	GND1	-	VBAT	-	Ground	B
12	C5	GND2	-	VBAT	-	Ground	B
13	E3	RGBGND	-	VBAT	-	Ground	B
14	C2	RGBISET	I	VBAT	GND	RGB LED reference current	O
15	D4	R1LED	I	-	GND	Red LED1 connected	E
16	E4	G1LED	I	-	GND	Green LED1 connected	E
17	D3	B1LED	I	-	GND	Blue LED1 connected	E
18	D2	R2LED	I	-	GND	Red LED2 connected	E
19	E2	G2LED	I	-	GND	Green LED2 connected	E
20	D1	B2LED	I	-	GND	Blue LED2 connected	E
21	C3	RGB1CNT	I	VBAT	GND	RGB1 LED external ON/OFF Synchronism (L : OFF, H : ON)*	J
22	A2	RGB2CNT	I	VBAT	GND	RGB2 LED external ON/OFF Synchronism (L : OFF, H : ON)*	J
23	C4	ADDSEL	I	VBAT	GND	I <sup>2</sup> C device address change terminal	R
24	B3	CLKIO	I/O	VBAT	GND	Standard clock input-and-output terminal	V

\* A setup of a register is separately necessary to validate it.

●Equivalent circuit diagram

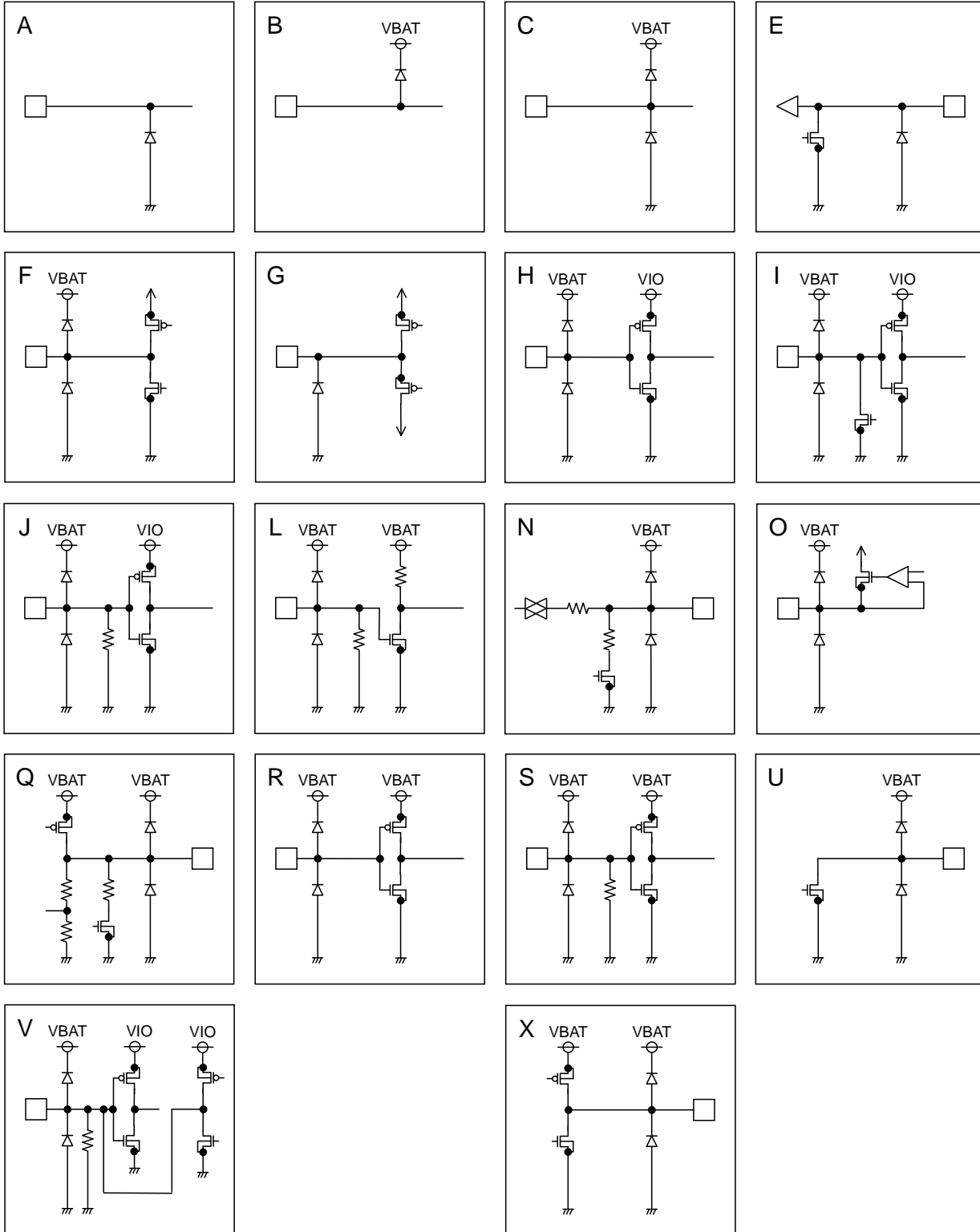

● I<sup>2</sup>C BUS format

The writing operation is based on the I<sup>2</sup>C slave standard.

- Slave address

	A7	A6	A5	A4	A3	A2	A1	R/W
ADDSEL=L	0	0	1	1	0	1	0	0
ADDSEL=H	0	0	1	1	0	1	1	0

Slave address can be changed with the external terminal ADDSEL.

- Bit Transfer

SCL transfers 1-bit data during H. SCL cannot change signal of SDA during H at the time of bit transfer. If SDA changes while SCL is H, START conditions or STOP conditions will occur and it will be interpreted as a control signal.

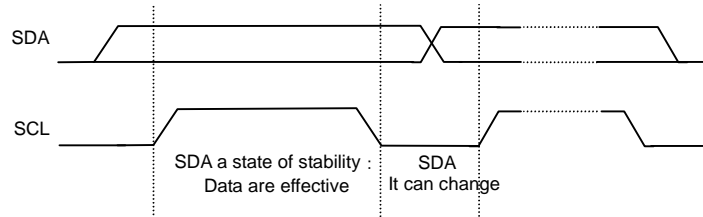

- START and STOP condition

When SDA and SCL are H, data is not transferred on the I<sup>2</sup>C- bus. This condition indicates, if SDA changes from H to L while SCL has been H, it will become START (S) conditions, and an access start, if SDA changes from L to H while SCL has been H, it will become STOP (P) conditions and an access end.

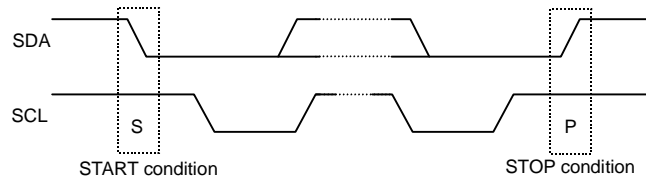

- Acknowledge

It transfers data 8 bits each after the occurrence of START condition. A transmitter opens SDA after transfer 8bits data, and a receiver returns the acknowledge signal by setting SDA to L.

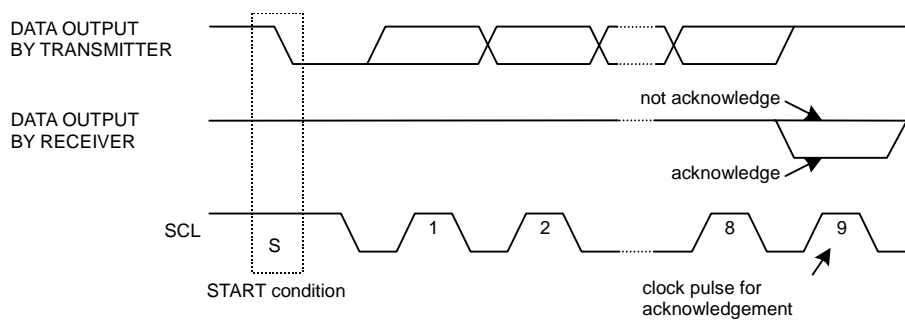

• Writing protocol

A register address is transferred by the next 1 byte that transferred the slave address and the write-in command. The 3rd byte writes data in the internal register written in by the 2nd byte, and after 4th byte or, the increment of register address is carried out automatically. However, when a register address turns into the last address, it is set to 00h by the next transmission. After the transmission end, the increment of the address is carried out.

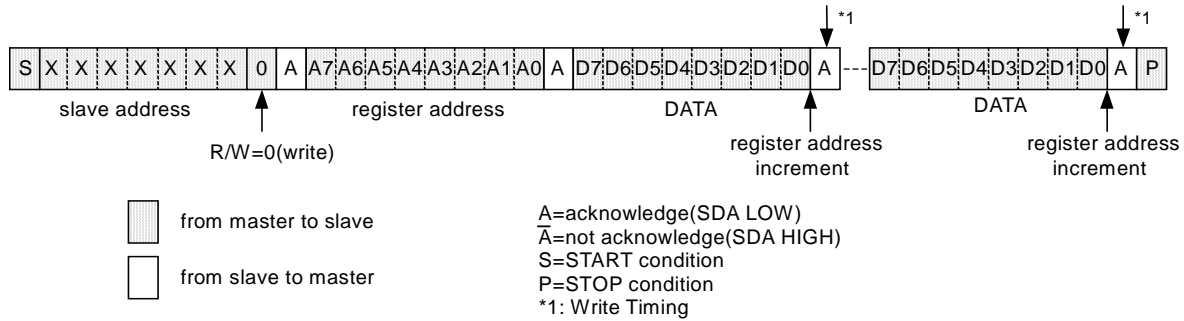

●Timing diagram

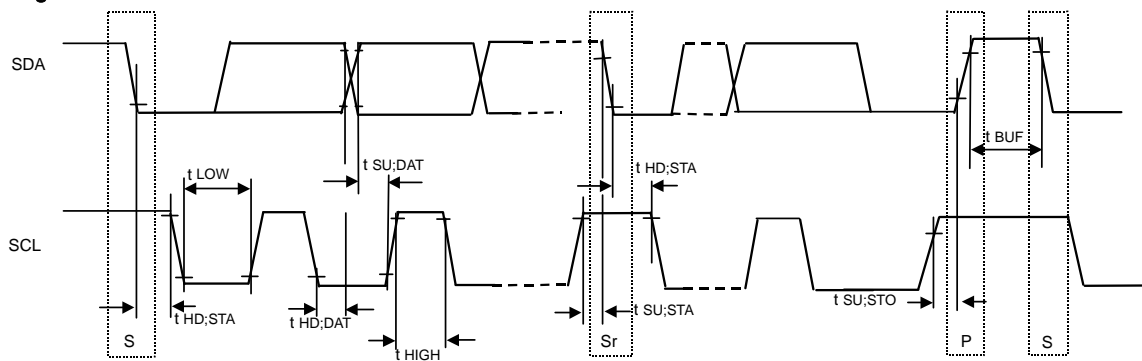

●Electrical Characteristics(Unless otherwise specified, Ta=25 °C, VBAT=3.6V, VIO=1.8V)

Parameter	Symbol	Standard-mode			Fast-mode			Unit
		Min.	Typ.	Max.	Min.	Typ.	Max.	
<b>[I<sup>2</sup>C BUS format]</b>								
SCL clock frequency	fSCL	0	-	100	0	-	400	kHz
LOW period of the SCL clock	tLOW	4.7	-	-	1.3	-	-	μs
HIGH period of the SCL clock	tHIGH	4.0	-	-	0.6	-	-	μs
Hold time (repeated) START condition After this period, the first clock is generated	tHD;STA	4.0	-	-	0.6	-	-	μs
Set-up time for a repeated START condition	tSU;STA	4.7	-	-	0.6	-	-	μs
Data hold time	tHD;DAT	0	-	3.45	0	-	0.9	μs
Data set-up time	tSU;DAT	250	-	-	100	-	-	ns
Set-up time for STOP condition	tSU;STO	4.0	-	-	0.6	-	-	μs
Bus free time between a STOP and START condition	tBUF	4.7	-	-	1.3	-	-	μs



## ● Register map

Address	W/R	Register data								Function
		D7	D6	D5	D4	D3	D2	D1	D0	
00h	W	-	-	CLKMD	CLKEN	-	-	-	SFTRST	Soft Reset clock setup
01h	W	-	RGB2MEL	RGB2OS	RGB2EN	-	RGB1MEL	RGB1OS	RGB1EN	RGB-LED control
02h	W	SFRGB1(1)	SFRGB1(0)	SRRGB1(1)	SRRGB1(0)	-	TRGB1(2)	TRGB1(1)	TRGB1(0)	RGB1-hour setup
03h	W	-	IR11(6)	IR11(5)	IR11(4)	IR11(3)	IR11(2)	IR11(1)	IR11(0)	R1 current 1 setup
04h	W	-	IR12(6)	IR12(5)	IR12(4)	IR12(3)	IR12(2)	IR12(1)	IR12(0)	R1 current 2 setup
05h	W	-	-	-	-	PR1(3)	PR1(2)	PR1(1)	PR1(0)	R1 Wave patturn setup
06h	W	-	IG11(6)	IG11(5)	IG11(4)	IG11(3)	IG11(2)	IG11(1)	IG11(0)	G1 current 1 setup
07h	W	-	IG12(6)	IG12(5)	IG12(4)	IG12(3)	IG12(2)	IG12(1)	IG12(0)	G1 current 2 setup
08h	W	-	-	-	-	PG1(3)	PG1(2)	PG1(1)	PG1(0)	G1 Wave patturn setup
09h	W	-	IB11(6)	IB11(5)	IB11(4)	IB11(3)	IB11(2)	IB11(1)	IB11(0)	B1 current 1 setup
0Ah	W	-	IB12(6)	IB12(5)	IB12(4)	IB12(3)	IB12(2)	IB12(1)	IB12(0)	B1 current 2 setup
0Bh	W	-	-	-	-	PB1(3)	PB1(2)	PB1(1)	PB1(0)	B1 Wave patturn setup
0Ch	W	SFRGB2(1)	SFRGB2(0)	SRRGB2(1)	SRRGB2(0)	-	TRGB2(2)	TRGB2(1)	TRGB2(0)	RGB2-hour setup
0Dh	W	-	IR21(6)	IR21(5)	IR21(4)	IR21(3)	IR21(2)	IR21(1)	IR21(0)	R2 current 1 setup
0Eh	W	-	IR22(6)	IR22(5)	IR22(4)	IR22(3)	IR22(2)	IR22(1)	IR22(0)	R2 current 2 setup
0Fh	W	-	-	-	-	PR2(3)	PR2(2)	PR2(1)	PR2(0)	R2 Wave patturn
10h	W	-	IG21(6)	IG21(5)	IG21(4)	IG21(3)	IG21(2)	IG21(1)	IG21(0)	G2 current 1 setup
11h	W	-	IG22(6)	IG22(5)	IG22(4)	IG22(3)	IG22(2)	IG22(1)	IG22(0)	G2 current 2 setup
12h	W	-	-	-	-	PG2(3)	PG2(2)	PG2(1)	PG2(0)	G2 Wave patturn setup
13h	W	-	IB21(6)	IB21(5)	IB21(4)	IB21(3)	IB21(2)	IB21(1)	IB21(0)	B2 current 1 setup
14h	W	-	IB22(6)	IB22(5)	IB22(4)	IB22(3)	IB22(2)	IB22(1)	IB22(0)	B2 current 2 setup
15h	W	-	-	-	-	PB2(3)	PB2(2)	PB2(1)	PB2(0)	B2 Wave patturn setup

Input "0" for "-".

Vacancy address may be use for test.

Prohibit to accessing the address that isn't mentioned and the register for test.

●Register Description

Address 00h <Soft Reset>

BIT	Name	Initial	Function	
			0	1
D7	-	-	-	-
D6	-	-	-	-
D5	CLKMD	0	Clock Input mode	Clock Output mode
D4	CLKEN	0	Clock input and output invalid	Clock input and output Effective
D3	-	-	-	-
D2	-	-	-	-
D1	-	-	-	-
D0	SFTRST	0	Reset Release	Reset

Address 01h <RGB LED control >

BIT	Name	Init	Function	
			0	1
D7	-	-	-	-
D6	RGB2MEL	0	RGB2 external control invalid	RGB2 external control valid
D5	RGB2OS	0	RGB2 Stop	RGB2 1 periodic operation
D4	RGB2EN	0	RGB2 Stop	RGB2 continuous operation
D3	-	-	-	-
D2	RGB1MEL	0	RGB1 external control invalid	RGB1 external control valid
D1	RGB1OS	0	RGB1 Stop	RGB1 1 periodic operation
D0	RGB1EN	0	RGB1 Stop	RGB1 continuous operation

- \* RGB\*OS returns to 0 automatically after 1 cycle operation.
- \* RGB\*EN precedes to RGB\*OS. In use in 1 cycle operation, there is the necessity for RGB\*EN=0.

Address 02h <RGB1 time>

BIT	Name	Init	Function			
			0		1	
D7	SFRGB1(1)	0	SFRGB1(1)		Slope Down transition	
			0	0	0	
			0	1	Wave form cycle / 16	
			1	0	Wave form cycle / 8	
D6	SFRGB1(0)	0	SFRGB1(0)		Wave form cycle / 4	
			1	1	Wave form cycle / 4	
			It is a theoretical value on logic control, and the reaction time of the analog section is not included."Slope time" is the time from a slope start to a slope end.			
			-			
D5	SRRGB1(1)	0	SRRGB1(1)		Slope Up transition	
			0	0	0	
			0	1	Wave form cycle / 16	
			1	0	Wave form cycle / 8	
D4	SRRGB1(0)	0	SRRGB1(0)		Wave form cycle / 4	
			1	1	Wave form cycle / 4	
			It is a theoretical value on logic control, and the reaction time of the analog section is not included."Slope time" is the time from a slope start to a slope end.			
			-			
D2	TRGB1(2)	0	TRGB1(2)	TRGB1(1)	TRGB1(0)	Wave form cycle
			0	0	0	0.131 s
			0	0	1	0.52 s
			0	1	0	1.05 s
D1	TRGB1(1)	0	0	1	1	2.10 s
			1	0	0	4.19 s
			1	0	1	8.39 s
			1	1	0	12.6 s
D0	TRGB1(0)	0	1	1	1	16.8 s
			-			
			-			
			-			

Setting time is counted based on the frequency of OSC. The above-mentioned value is a value at the time of Typ (1MHz). When operating by the external clock, input frequency is a value at the time of Typ (250kHz).

\* Refer to "●Use of a RGB wave setup" for the detailed function of each register of this page.

Address 03h &lt;R1 current 1setup &gt;

BIT	Name	Init	Function						Current	
			0			1				
D7	-	-	-						-	
D6	IR11(6)	0	IR11(6)	IR11(5)	IR11(4)	IR11(3)	IR11(2)	IR11(1)	IR11(0)	Current
D5	IR11(5)	0	0	0	0	0	0	0	0	0
D4	IR11(4)	0	0	0	0	0	0	0	1	0.2mA
D3	IR11(3)	0	.	.	.	.	.	.	.	0.2mA step
D2	IR11(2)	0	1	1	1	1	1	1	0	25.2mA
D1	IR11(1)	0	1	1	1	1	1	1	1	25.4mA
D0	IR11(0)	0	At RGBISETpin 120kΩ connection							

Address 04h &lt;R1 current2 setup &gt;

BIT	Name	Init	Function						Current	
			0			1				
D7	-	-	-						-	
D6	IR12(6)	0	IR12(6)	IR12(5)	IR12(4)	IR12(3)	IR12(2)	IR12(1)	IR12(0)	Current
D5	IR12(5)	0	0	0	0	0	0	0	0	0
D4	IR12(4)	0	0	0	0	0	0	0	1	0.2mA
D3	IR12(3)	0	.	.	.	.	.	.	.	0.2mA step
D2	IR12(2)	0	1	1	1	1	1	1	0	25.2mA
D1	IR12(1)	0	1	1	1	1	1	1	1	25.4mA
D0	IR12(0)	0	At RGBISETpin 120kΩ connection							

Address 05h &lt;R1 Wave Pattern &gt;

BIT	Name	Init	Function				Wave
			0		1		
D7	-	-	-				-
D6	-	-	-				-
D5	-	-	-				-
D4	-	-	-				-
D3	PR1(3)	0	PR1(3)	PR1(2)	PR1(1)	PR1(0)	Wave
			0	0	0	0	Pattern1
			0	0	0	1	Pattern2
D2	PR1(2)	1	0	0	1	0	Pattern3
			.	.	.	.	.
D1	PR1(1)	1	.	.	.	.	.
			1	1	0	1	Pattern14
			1	1	1	0	Pattern15
D0	PR1(0)	1	1	1	1	1	Pattern16

Address 06h &lt;G1 current1 setup &gt;

BIT	Name	Init	Function						Current	
			0			1				
D7	-	-	-						-	
D6	IG11(6)	0	IG11(6)	IG11(5)	IG11(4)	IG11(3)	IG11(2)	IG11(1)	IG11(0)	Current
D5	IG11(5)	0	0	0	0	0	0	0	0	0
D4	IG11(4)	0	0	0	0	0	0	0	1	0.2mA
D3	IG11(3)	0	.	.	.	.	.	.	.	0.2mA step
D2	IG11(2)	0	1	1	1	1	1	1	0	25.2mA
D1	IG11(1)	0	1	1	1	1	1	1	1	25.4mA
D0	IG11(0)	0	At RGBISETpin 120kΩ connection							

\* Refer to "●Use of a RGB wave setup " for the detailed function of each register of this page.

Address 07h <G1 current2 setup >

BIT	Name	Init	Function							
			0				1			
D7	-	-	-				-			
D6	IG12(6)	0	IG12(6)	IG12(5)	IG12(4)	IG12(3)	IG12(2)	IG12(1)	IG12(0)	Current
D5	IG12(5)	0	0	0	0	0	0	0	0	0
D4	IG12(4)	0	0	0	0	0	0	0	1	0.2mA
D3	IG12(3)	0	.	.	.	.	.	.	.	0.2mA step
D2	IG12(2)	0	1	1	1	1	1	1	0	25.2mA
D1	IG12(1)	0	1	1	1	1	1	1	1	25.4mA
D0	IG12(0)	0	At RGBISETpin 120kΩ connection							

Address 08h <G1 G1 Wave Pattern >

BIT	Name	Init	Function				
			0		1		
D7	-	-	-		-		
D6	-	-	-		-		
D5	-	-	-		-		
D4	-	-	-		-		
D3	PG1(3)	0	PG1(3)	PG1(2)	PG1(1)	PG1(0)	Wave
D2	PG1(2)	1	0	0	0	0	Pattern 1
			0	0	0	1	Pattern 2
D1	PG1(1)	1	0	0	1	0	Pattern 3
			.	.	.	.	.
D0	PG1(0)	1	1	1	0	1	Pattern 14
			1	1	1	0	Pattern 15
			1	1	1	1	Pattern 16

Address 09h <B1 current1setup >

BIT	Name	Init	Function							
			0				1			
D7	-	-	-				-			
D6	IB11(6)	0	IB11(6)	IB11(5)	IB11(4)	IB11(3)	IB11(2)	IB11(1)	IB11(0)	Current
D5	IB11(5)	0	0	0	0	0	0	0	0	0
D4	IB11(4)	0	0	0	0	0	0	0	1	0.2mA
D3	IB11(3)	0	.	.	.	.	.	.	.	0.2mA step
D2	IB11(2)	0	1	1	1	1	1	1	0	25.2mA
D1	IB11(1)	0	1	1	1	1	1	1	1	25.4mA
D0	IB11(0)	0	At RGBISETpin 120kΩ connection							

Address 0Ah <B1 current2setup >

BIT	Name	Init	Function							
			0				1			
D7	-	-	-				-			
D6	IB12(6)	0	IB12(6)	IB12(5)	IB12(4)	IB12(3)	IB12(2)	IB12(1)	IB12(0)	Current
D5	IB12(5)	0	0	0	0	0	0	0	0	0
D4	IB12(4)	0	0	0	0	0	0	0	1	0.2mA
D3	IB12(3)	0	.	.	.	.	.	.	.	0.2mA step
D2	IB12(2)	0	1	1	1	1	1	1	0	25.2mA
D1	IB12(1)	0	1	1	1	1	1	1	1	25.4mA
D0	IB12(0)	0	At RGBISETpin 120kΩ connection							

\* Refer to "●Use of a RGB wave setup " for the detailed function of each register of this page.

Address 0Bh &lt;B1 Wave Pattern &gt;

BIT	Name	Init	Function				
			0	1			
D7	-	-	-	-			
D6	-	-	-	-			
D5	-	-	-	-			
D4	-	-	-	-			
D3	PB1(3)	0	PB1(3)	PB1(2)	PB1(1)	PB1(0)	Wave
			0	0	0	0	Pattern1
D2	PB1(2)	1	0	0	0	1	Pattern2
			0	0	1	0	Pattern3
D1	PB1(1)	1	.	.	.	.	.
			.	.	.	.	.
D0	PB1(0)	1	1	1	0	1	Pattern14
			1	1	1	0	Pattern15
			1	1	1	1	Pattern16

Address 0Ch &lt;RGB2 time &gt;

BIT	Name	Init	Function			
			0	1		
D7	SFRGB2(1)	0	SFRGB2(1)	SFRGB2(0)	Slope Down transition	
			0	0	0	
			0	1	Wave form cycle / 16	
			1	0	Wave form cycle / 8	
D6	SFRGB2(0)	0	1	1	Wave form cycle / 4	
			It is a theoretical value on logic control, and the reaction time of the analog section is not included. "Slope time" is the time from a slope start to a slope end.			
D5	SRRGB2(1)	0	SRRGB2(1)	SRRGB2(0)	Slope up transition	
			0	0	0	
			0	1	Wave form cycle / 16	
			1	0	Wave form cycle / 8	
D4	SRRGB2(0)	0	1	1	Wave form cycle / 4	
			It is a theoretical value on logic control, and the reaction time of the analog section is not included. "Slope time" is the time from a slope start to a slope end.			
D3	-	-	-	-	-	
D2	TRGB2(2)	0	TRGB2(2)	TRGB2(1)	TRGB2(0)	Wave form cycle
			0	0	0	0.131 s
D1	TRGB2(1)	0	0	0	1	0.52 s
			0	1	0	1.05 s
D0	TRGB2(0)	0	0	1	1	2.10 s
			1	0	0	4.19 s
			1	0	1	8.39 s
			1	1	0	12.6 s
			1	1	1	16.8 s

Setting time is counted based on the frequency of OSC. The above-mentioned value is a value at the time of Typ (1MHz).  
When operating by the external clock, input frequency is a value at the time of Typ (250kHz)

\* Refer to "●Use of a RGB wave setup " for the detailed function of each register of this page.

Address 0Dh <R2 current 1setup>

BIT	Name	Init	Function							
			0				1			
D7	-	-	-				-			
D6	IR21(6)	0	IR21(6)	IR21(5)	IR21(4)	IR21(3)	IR21(2)	IR21(1)	IR21(0)	Current
D5	IR21(5)	0	0	0	0	0	0	0	0	0
D4	IR21(4)	0	0	0	0	0	0	0	1	0.2mA
D3	IR21(3)	0	.	.	.	.	.	.	.	0.2mA step
D2	IR21(2)	0	1	1	1	1	1	1	0	25.2mA
D1	IR21(1)	0	1	1	1	1	1	1	1	25.4mA
D0	IR21(0)	0	At RGBISETpin 120kΩ connection							

Address 0Eh <R2 current 2setup>

BIT	Name	Init	Function							
			0				1			
D7	-	-	-				-			
D6	IR22(6)	0	IR22(6)	IR22(5)	IR22(4)	IR22(3)	IR22(2)	IR22(1)	IR22(0)	Current
D5	IR22(5)	0	0	0	0	0	0	0	0	0
D4	IR22(4)	0	0	0	0	0	0	0	1	0.2mA
D3	IR22(3)	0	.	.	.	.	.	.	.	0.2mA step
D2	IR22(2)	0	1	1	1	1	1	1	0	25.2mA
D1	IR22(1)	0	1	1	1	1	1	1	1	25.4mA
D0	IR22(0)	0	At RGBISETpin 120kΩ connection							

Address 0Fh <R2 Wave Pattern setup>

BIT	Name	Init	Function				
			0		1		
D7	-	-	-		-		
D6	-	-	-		-		
D5	-	-	-		-		
D4	-	-	-		-		
D3	PR2(3)	0	PR2(3)	PR2(2)	PR2(1)	PR2(0)	Wave
D2	PR2(2)	1	0	0	0	0	Pattern 1
			0	0	0	1	Pattern 2
D1	PR2(1)	1	0	0	1	0	Pattern 3
			.	.	.	.	.
D0	PR2(0)	1	1	1	0	1	Pattern 14
			1	1	1	0	Pattern 15
			1	1	1	1	Pattern 16

Address 10h <G2 current 1setup>

BIT	Name	Init	Function							
			0				1			
D7	-	-	-				-			
D6	IG21(6)	0	IG21(6)	IG21(5)	IG21(4)	IG21(3)	IG21(2)	IG21(1)	IG21(0)	Current
D5	IG21(5)	0	0	0	0	0	0	0	0	0
D4	IG21(4)	0	0	0	0	0	0	0	1	0.2mA
D3	IG21(3)	0	.	.	.	.	.	.	.	0.2mA step
D2	IG21(2)	0	1	1	1	1	1	1	0	25.2mA
D1	IG21(1)	0	1	1	1	1	1	1	1	25.4mA
D0	IG21(0)	0	At RGBISETpin 120kΩ connection							

\* Refer to "●Use of a RGB wave setup " for the detailed function of each register of this page.

Address 11h <G2 current 2setup>

BIT	Name	Init	Function							
			0				1			
D7	-	-	-				-			
D6	IG22(6)	0	IG22(6)	IG22(5)	IG22(4)	IG22(3)	IG22(2)	IG22(1)	IG22(0)	Current
D5	IG22(5)	0	0	0	0	0	0	0	0	0
D4	IG22(4)	0	0	0	0	0	0	0	1	0.2mA
D3	IG22(3)	0	.	.	.	.	.	.	.	0.2mA step
D2	IG22(2)	0	1	1	1	1	1	1	0	25.2mA
D1	IG22(1)	0	1	1	1	1	1	1	1	25.4mA
D0	IG22(0)	0	At RGBISETpin 120kΩ connection							

Address 12h <G2 Wave Pattern setup >

BIT	Name	Init	Function				
			0		1		
D7	-	-	-		-		
D6	-	-	-		-		
D5	-	-	-		-		
D4	-	-	-		-		
D3	PG2(3)	0	PG2(3)	PG2(2)	PG2(1)	PG2(0)	Wave
			0	0	0	0	Pattern 1
			0	0	0	1	Pattern 2
D2	PG2(2)	1	0	0	1	0	Pattern 3
			.	.	.	.	.
D1	PG2(1)	1	.	.	.	.	.
			1	1	0	1	Pattern 14
			1	1	1	0	Pattern 15
D0	PG2(0)	1	1	1	1	1	Pattern 16

Address 13h <B2 current 1setup>

BIT	Name	Init	Function							
			0				1			
D7	-	-	-				-			
D6	IB21(6)	0	IB21(6)	IB21(5)	IB21(4)	IB21(3)	IB21(2)	IB21(1)	IB21(0)	Current
D5	IB21(5)	0	0	0	0	0	0	0	0	0
D4	IB21(4)	0	0	0	0	0	0	0	1	0.2mA
D3	IB21(3)	0	.	.	.	.	.	.	.	0.2mA step
D2	IB21(2)	0	1	1	1	1	1	1	0	25.2mA
D1	IB21(1)	0	1	1	1	1	1	1	1	25.4mA
D0	IB21(0)	0	At RGBISETpin 120kΩ connection							

Address 14h <B2 current 2setup>

BIT	Name	Init	Function							
			0				1			
D7	-	-	-				-			
D6	IB22(6)	0	IB22(6)	IB22(5)	IB22(4)	IB22(3)	IB22(2)	IB22(1)	IB22(0)	Current
D5	IB22(5)	0	0	0	0	0	0	0	0	0
D4	IB22(4)	0	0	0	0	0	0	0	1	0.2mA
D3	IB22(3)	0	.	.	.	.	.	.	.	0.2mA step
D2	IB22(2)	0	1	1	1	1	1	1	0	25.2mA
D1	IB22(1)	0	1	1	1	1	1	1	1	25.4mA
D0	IB22(0)	0	At RGBISETpin 120kΩ connection							

\* Refer to "●Use of a RGB wave setup " for the detailed function of each register of this page.

Address 15h <B2 Wave Pattern setup >

BIT	Name	Init	Function				
			0		1		
D7	-	-	-		-		
D6	-	-	-		-		
D5	-	-	-		-		
D4	-	-	-		-		
D3	PB2(3)	0	PB2(3)	PB2(2)	PB2(1)	PB2(0)	Wave
			0	0	0	0	Pattern 1
D2	PB2(2)	1	0	0	0	1	Pattern 2
			0	0	1	0	Pattern 3
D1	PB2(1)	1	.	.	.	.	.
			.	.	.	.	.
D0	PB2(0)	1	1	1	0	1	Pattern 14
			1	1	1	0	Pattern 15
			1	1	1	1	Pattern 16

\* Refer to "●Use of a RGB wave setup " for the detailed function of each register of this page.



### ● RGB LED Driver Operation Description

- Two drivers "RGB1 (R1LED, G1LED, B1LED)" and "RGB2 (R2LED, G2LED, B2LED)" are mounted.
- A slope function is incorporated to control drivers independently.
- Refer to ● RGB Waveform Setting for more information about output waveform setting.
- The LED current can be set via a resistance value (RISET) to be connected to the RGBISET terminal. The maximum current value can be derived from the following expression:

$$I_{LEDmax} [A] = 3.048 / RISET [k\Omega] (Typ)$$

However, this setting must be made so that the maximum current value can be less than or equal to 30.48mA. In addition, the RGBISET terminal has an overcurrent protection circuit to prevent the excessive LED current from flowing for low impedance to the ground.

- Note that the setting voltage shall be higher than or equal to a saturation voltage (0.2V) in the constant current circuit. When LED Vf is large, the LED destination shall be connected to another step-up circuit.

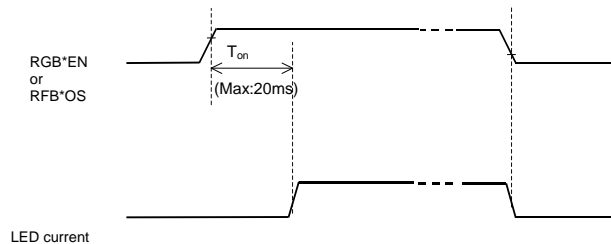

- The LED destination is fixed before on (RGB\*EN=Hi or RGB\*OS=Hi).

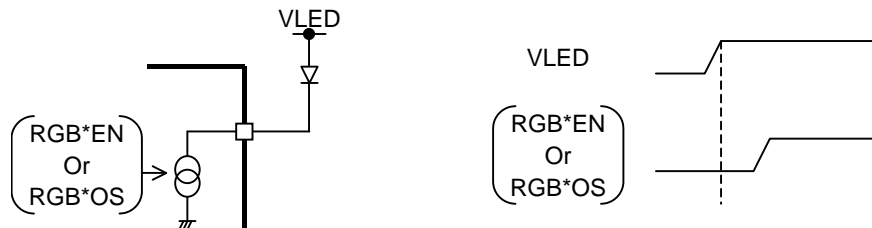

### ●The synchronism of RGB1/RGB2

The period of RGB1 and RGB2 and start, stop timing can be set up independently.

When synchronizes RGB1 and RGB2, You must start an internal counter at the same time under the state of resetting. (Internal Counter are prepared for each of RGB1 and RGB2, so You must reset both.)

<How to reset internal Counter>

Inside Counter can be reset by carrying out one of following actions.

- Reset by hard reset (RSTB\_IL). (RGB1, RGB2 is reset together.)
- Reset by soft reset. (RGB1, RGB2 is reset together.)
- It is written register of the current setup (I1 · I2), the slope setup, the period setup and the pattern setup. Internal Counter of RGB1 is reset when it is written between Address=0Bh from 02h. Internal Counter of RGB2 is reset when it is written between Address=15h from 0Ch. Counter is reset as to overwriting the same value.

Note)

Internal Counter isn't reset if write RGB1EN =L and RGB2EN =L. (Address=01h).

When it write RGB1EN=L (RGB2EN=L), inside Counter is held, and IC will operate from the held state at next restart.

### ●RGB Waveform Setting

Various kinds of RGB control can be implemented by designating waveform cycles, waveform patterns, current settings 1, 2 and rising/falling slope times.

To activate a RGB waveform, a continuous operation via RGB\*EN or a single-shot operation via RGB\*OS can be selected. In addition, when control via the external terminal RGB\*CNT is enabled via RGB\*MEL, the corresponding LED can be lit in synchronization with the external signal.

1. Waveform cycle
  - A single cycle time is set for a waveform pattern.
  - This setting can be made independently for RGB1 and RGB2.
2. Waveform pattern
  - A pattern in a waveform cycle is set.
  - Sixteen types of waveform patterns can be set in units of waveform patterns.
  - For concrete waveform patterns, refer to the timing diagram shown on the next page.
3. Current settings 1 and 2 (I1, I2)
  - Two currents in a waveform pattern are set.
  - When the maximum current value is 25.4mA, it is possible to set the current ranging from 0 to 25.4mA with an increment of 0.2mA (128 steps).
  - The polarity of a waveform is determined by the greater-than/ less-than relationship in the current setting.
  - This setting can be made in units of terminals.
4. Rising/falling slope time
  - A current change time during switching between current settings 1 and 2 is set.
  - A time per step (0.2mA) is calculated based on a difference between the currents selected in current settings 1, 2 and a setting slope time.
  - For this reason, a time per step (0.2mA) is short when a difference between setting currents I1 and I2 is large. In contrast, it is long when a difference between setting currents I1 and I2 is small.
  - Regardless of current settings 1 and 2, a rising slope time applies at current increase and a falling slope time applies at current decrease. For concrete waveform images, refer to the timing diagram shown on the next page.
5. External terminal synchronization control
 

When control via the external terminal RGB\*CNT is enabled via RGB\*MEL, lighting is enabled if the input external signal goes "H." In contrast, it is disabled if the external input signal goes "L." In this way, synchronization with the external signal is enabled so that LED can be blinked in conjunction with a ringing tone (a melody signaling a ringtone).

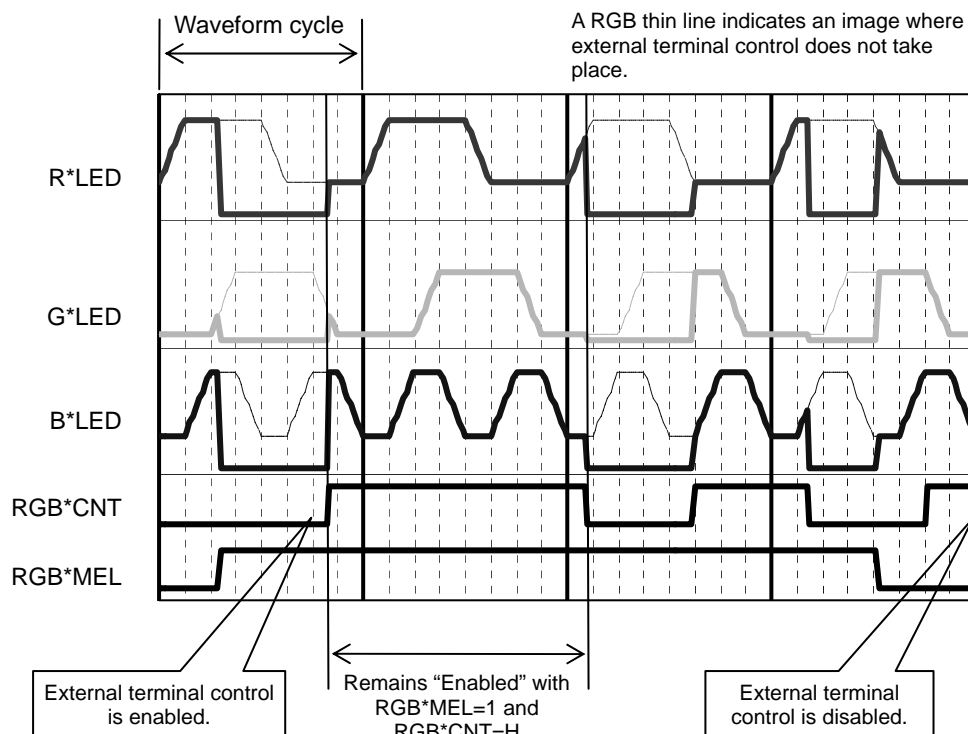

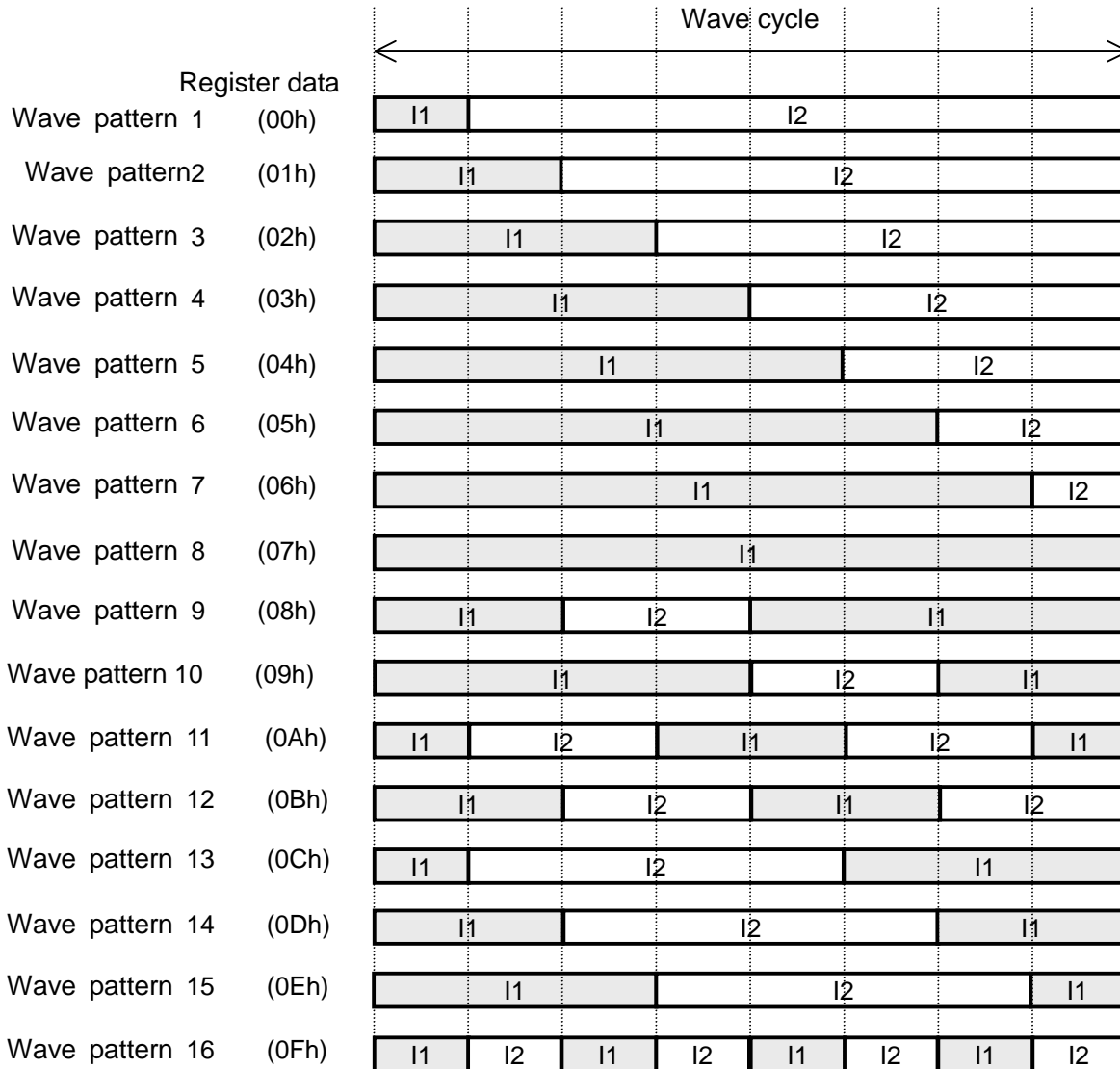

(ex) The image of current change of Wave pattern 11

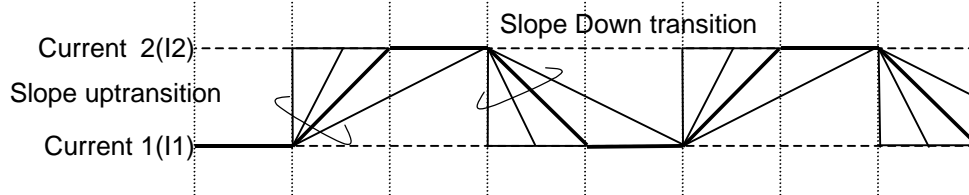

RGB wave setting timing diagram

6. Clock I/O

A reference clock I/O function is mounted in this IC chip. When two IC chips are used to extend an illumination capability, clock supply to the other RGB LED driver can be accomplished for synchronization with this LSI chip. This setting can be made via the register.

Clock output can be made with CLKEN=1 and CLKMD=1.

Register		CLKIO terminal state	Clock reception
CLKEN	CLKMD		
0	0/1	Input	Does not receive external clocks.
1	0	Input	Operates on external clocks.
	1	Output	-

- When two BD2802GU drivers are used and the clock is shared by CLKIO:  
Because a sequence is already programmed within an IC chip for RGB falling, "Enable" shall be set to "OFF" and clock supply shall be continued for at least three clocks so that operations can be performed using external clocks.

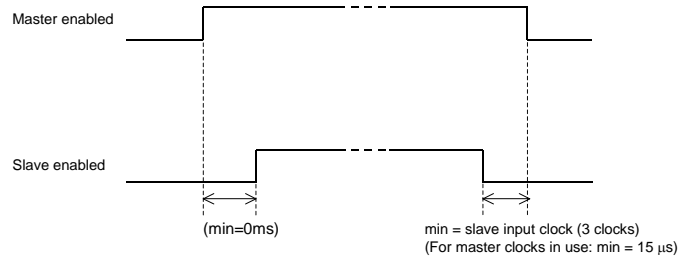

Master: Chip using CLKIO as output  
Slave: Chip using CLKIO as input

\*Even in independent slave mode, its setting "Enable" shall be reset to "OFF" and then clock supply must be continued for 3 clocks or more.  
Clock I/O switching shall be avoided during RGB operation.  
Enable: CLKEN, RGB1EN, RGB2EN, RGB1OS, RGB2OS

- Setting example

- Master side (clock output side)      RGB waveform setting
- ↓
- Slave side (clock input side)      RGB waveform setting
- ↓
- Master side      Clock output setting  
                    CLKEN=1, CLKMD=1      ... Performs clock output.
- ↓
- Slave side      Clock input setting  
                    CLKEN=1, CLKMD=0      ... Allows clock reception.
- ↓
- Master side      RGB lighting
- ↓
- ↓      This duration shall be short as much as possible.
- ↓
- Slave side      RGB lighting

7. RGB waveform setting examples

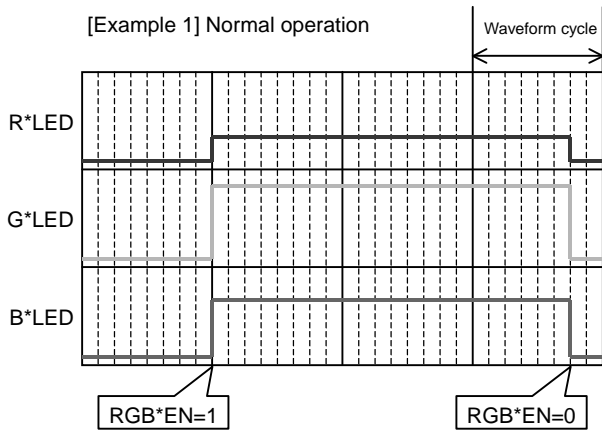

Selecting a waveform pattern 8 causes a continuous normal operation to take place through the setting current 1.

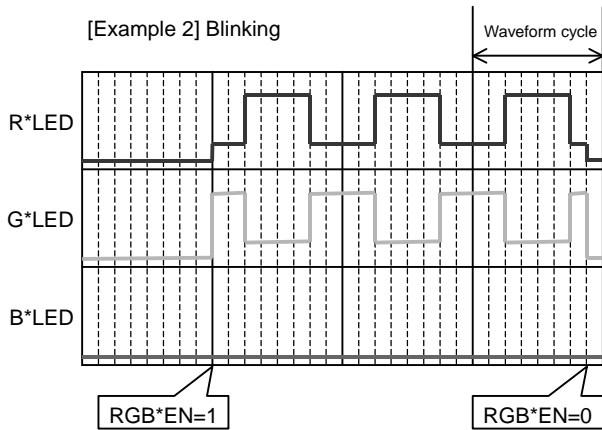

Setting a rising/falling slope time to "0" causes blinking to take place. Phase switching takes place via the setting currents of R and G.

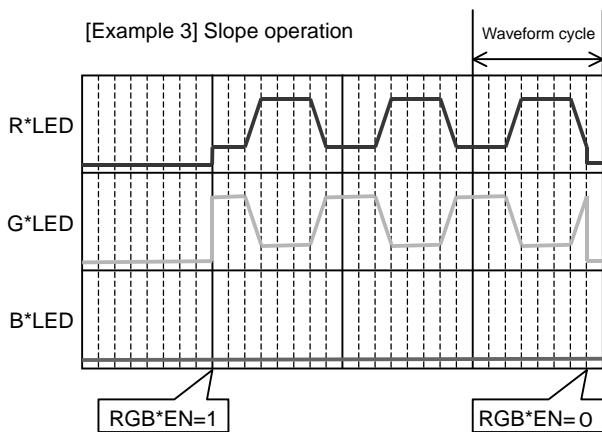

When a rising/falling slope time is longer than the setting made in example 2, a continuous color change is made by slope operation.

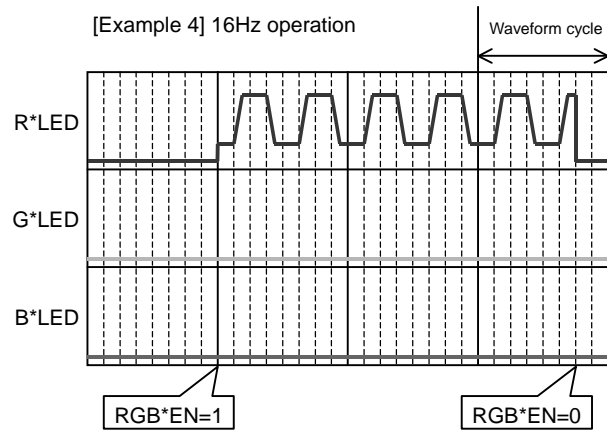

Combining the settings of a waveform pattern 11 and a waveform cycle 131ms causes blinking at a rate of 15.3Hz (approx. 16Hz).

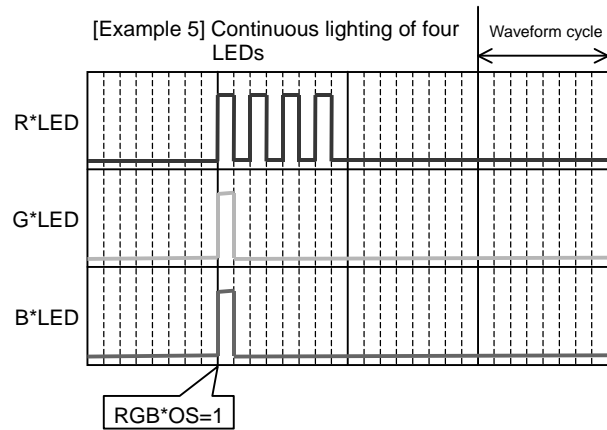

This example shows that lighting occurs continuously in the order of white, red, red and red. To achieve this, waveform patterns 16, 1 and RGB\*OS single cycle operation need to be combined.

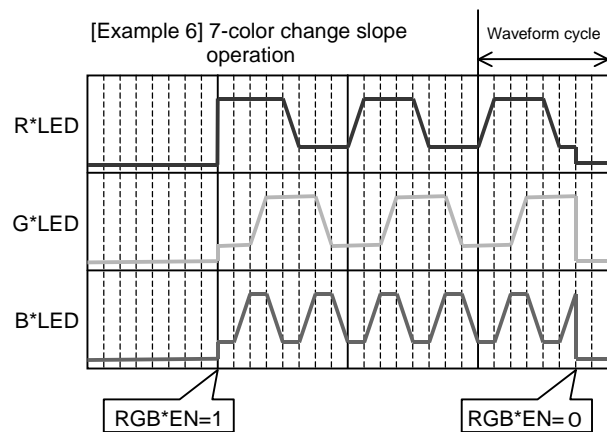

R, G and B waveform patterns are set in a way that any of R, G and B changes constantly.

8. RGB slope waveforms

- Example of waveform at activation

Current setting:  $I1 < I2$

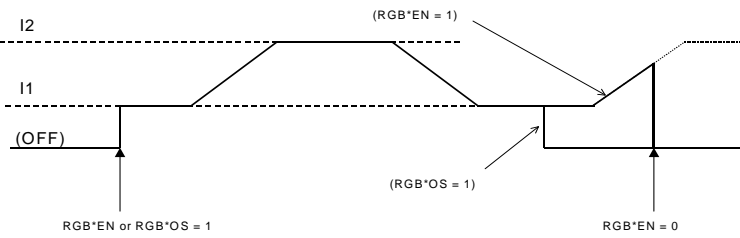

Current setting:  $I1 > I2$

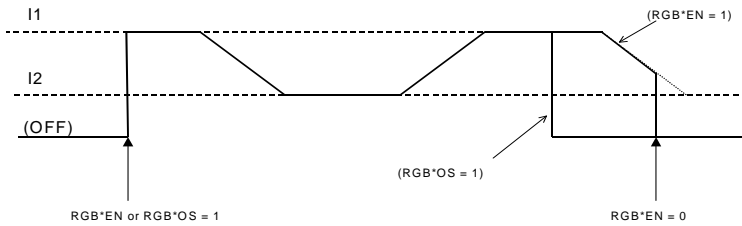

- Current difference in each channel (example)

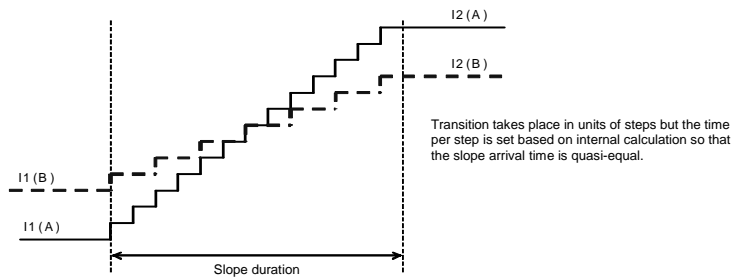

9. Setting change in slope duration

A slope operation is performed by an internal sequencer.

When an attempt is made to change the setting in a slope duration, the active slope operation is reset and a newly set slope operation is restarted.

In this case, however, LED lighting stops for a maximum of 16.4ms (OSC frequency=typ) for synchronization with the internal clock until the operation is restarted.

●Description of other operations

1. Reset

There are two types of reset: software reset and hardware reset.

(1) Software reset

- Setting the register (SFTRST) to "1" causes all the registers to be initialized.
- The registers subject to software reset automatically return to zero (Auto Return 0).

(2) Hardware reset

- Changing the RESETB terminal setting from "H" to "L" causes a state subject to hardware reset.
- Attempting hardware reset causes the states of all registers and output terminals to be initialized to their initial values, so that address reception is entirely stopped.
- Attempting reset in the hardware reset state causes the RESETB terminal state to change from "L" to "H" and vice versa.
- The RESETB terminal is provided with a filter circuit and a duration of 5µs or less with the terminal set to "L" is not recognized as hardware reset.

(3) Reset sequence

- When hardware reset is attempted during software reset, software reset is already cleared when hardware reset is cleared (because the software reset initial value is 0).

2. Thermal shutdown

The thermal shutdown is effective for LED and OSC portions.

The thermal shutdown function is activated when the detected temperature is approx. 195°C.

The detected temperature has a hysteresis and the detection cancel temperature is approx. 175°C (reference value in design).

3. I/O portion

While the RESETB terminal is in "L" state, no input signal is propagated to the IC logic portion because SDA and SCL input buffer operations are all stopped.

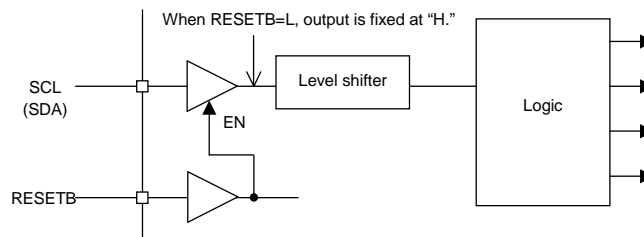

Special care should be taken because a current path may be formed via a terminal protection diode, depending on an I/O power-on sequence or an input level.

4. Power on/off sequence

Voltage shall be applied as follows at driver activation. When a delay element is connected to a VIO voltage source and a reset cancel signal is input to the RESETB terminal, special care should be taken to the rising time of VIO voltage to delay the RESETB signal without fail.

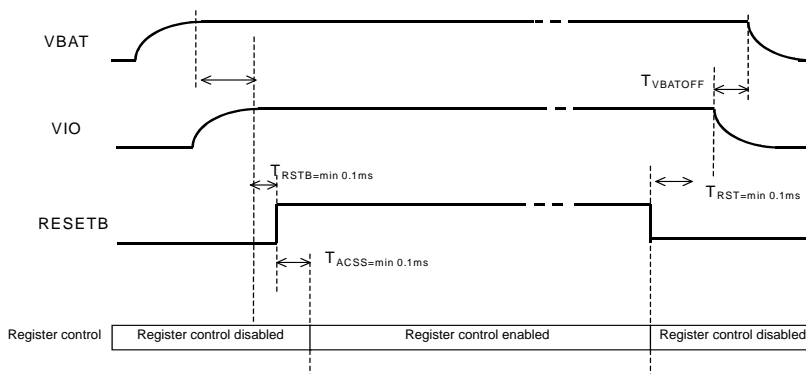

5. Terminating the unused terminals

Be sure to set the test terminals and unused terminals as summarized in the following table. In addition, refer to the preceding equivalent circuit and terminate the above terminals in a way that no problem occurs during actual use.

T1, T2, T3, T4	Test input terminals. Short-circuit these terminals to GND.
LED terminals not to be used	Short-circuit these terminals to GND. In this case, don't set the registers related to LEDs not to be used.
RGB1CNT, RGB2CNT	Short-circuit these terminals to GND. (Built-in pull-down resistance)
CLKIO	Short-circuit this terminal to GND. (Built-in pull-down resistance)
ADDSEL	Be sure to short-circuit this terminal to VBAT or GND.

●PCB pattern of the Power dissipation measuring board

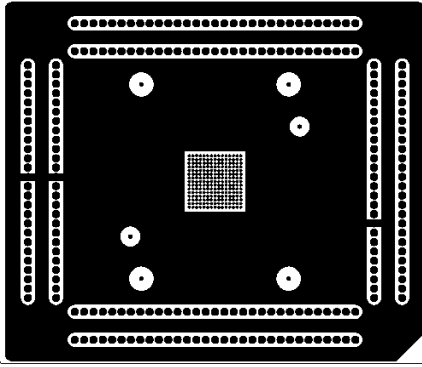

1<sup>st</sup> layer(component)

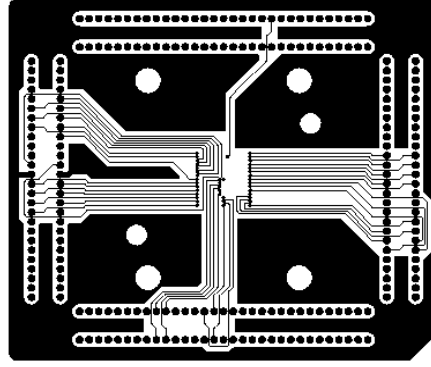

2<sup>nd</sup> layer

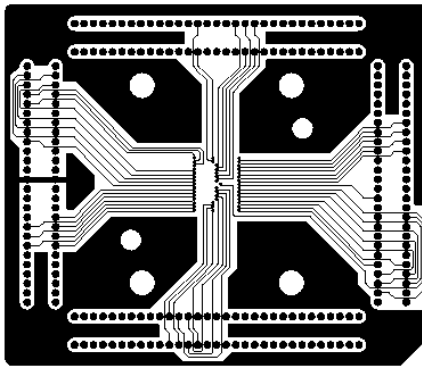

3<sup>rd</sup> layer

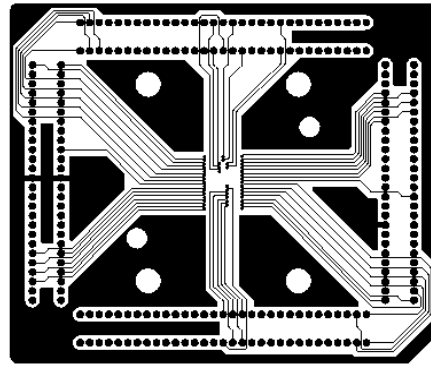

4<sup>th</sup> layer

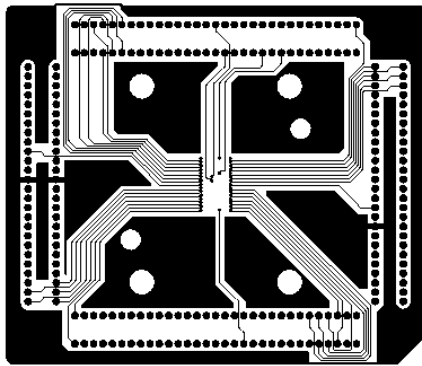

5<sup>th</sup> layer

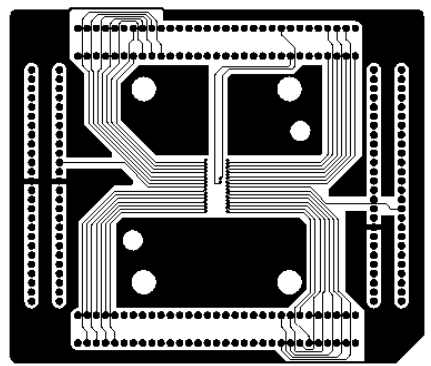

6<sup>th</sup> layer

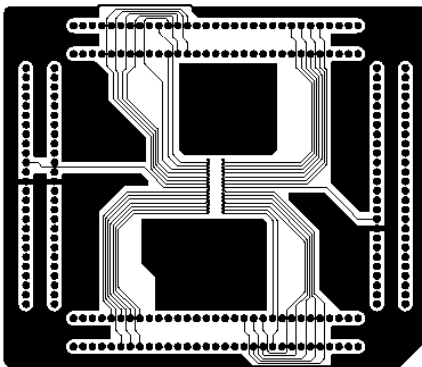

7<sup>th</sup> layer

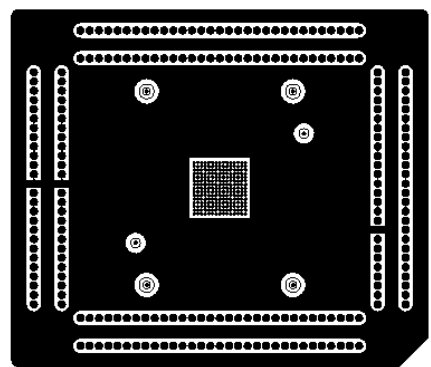

8<sup>th</sup> layer (solder)



**●Notes for Use**

- (1) Absolute Maximum Ratings  
An excess in the absolute maximum ratings, such as supply voltage, temperature range of operating conditions, etc., can break down devices, thus making impossible to identify breaking mode such as a short circuit or an open circuit. If any special mode exceeding the absolute maximum ratings is assumed, consideration should be given to take physical safety measures including the use of fuses, etc.
- (2) Power supply and ground line  
Design PCB pattern to provide low impedance for the wiring between the power supply and the ground lines. Pay attention to the interference by common impedance of layout pattern when there are plural power supplies and ground lines. Especially, when there are ground pattern for small signal and ground pattern for large current included the external circuits, please separate each ground pattern. Furthermore, for all power supply pins to ICs, mount a capacitor between the power supply and the ground pin. At the same time, in order to use a capacitor, thoroughly check to be sure the characteristics of the capacitor to be used present no problem including the occurrence of capacity dropout at a low temperature, thus determining the constant.
- (3) Ground voltage  
Make setting of the potential of the ground pin so that it will be maintained at the minimum in any operating state. Furthermore, check to be sure no pins are at a potential lower than the ground voltage including an actual electric transient.
- (4) Short circuit between pins and erroneous mounting  
In order to mount ICs on a set PCB, pay thorough attention to the direction and offset of the ICs. Erroneous mounting can break down the ICs. Furthermore, if a short circuit occurs due to foreign matters entering between pins or between the pin and the power supply or the ground pin, the ICs can break down.
- (5) Operation in strong electromagnetic field  
Be noted that using ICs in the strong electromagnetic field can malfunction them.
- (6) Input pins  
In terms of the construction of IC, parasitic elements are inevitably formed in relation to potential. The operation of the parasitic element can cause interference with circuit operation, thus resulting in a malfunction and then breakdown of the input pin. Therefore, pay thorough attention not to handle the input pins, such as to apply to the input pins a voltage lower than the ground respectively, so that any parasitic element will operate. Furthermore, do not apply a voltage to the input pins when no power supply voltage is applied to the IC. In addition, even if the power supply voltage is applied, apply to the input pins a voltage lower than the power supply voltage or within the guaranteed value of electrical characteristics.
- (7) External capacitor  
In order to use a ceramic capacitor as the external capacitor, determine the constant with consideration given to a degradation in the nominal capacitance due to DC bias and changes in the capacitance due to temperature, etc.
- (8) Thermal shutdown circuit (TSD)  
This LSI builds in a thermal shutdown (TSD) circuit. When junction temperatures become detection temperature or higher, the thermal shutdown circuit operates and turns a switch OFF. The thermal shutdown circuit, which is aimed at isolating the LSI from thermal runaway as much as possible, is not aimed at the protection or guarantee of the LSI. Therefore, do not continuously use the LSI with this circuit operating or use the LSI assuming its operation.
- (9) Thermal design  
Perform thermal design in which there are adequate margins by taking into account the permissible dissipation (Pd) in actual states of use.
- (10) About the pin for the test, the un-use pin  
Prevent a problem from being in the pin for the test and the un-use pin under the state of actual use. Please refer to a function manual and an application notebook. And, as for the pin that doesn't specially have an explanation, ask our company person in charge.
- (11) About the rush current  
Because the rush current flows momentarily for internal logic instability caused by a power-on sequence or delay, special care should be taken to the power supply coupling capacity, power supply, ground pattern wiring width and wiring.
- (12) About descriptions given in this document  
Though the function description and application node are design documents prepared for application design, we don't take liability for descriptions given in these documents. Be sure to decide applications after thoroughly investigating and evaluating the external devices as well as this BS2802GU LED driver.

● Power Dissipation (On the ROHM's standard board)

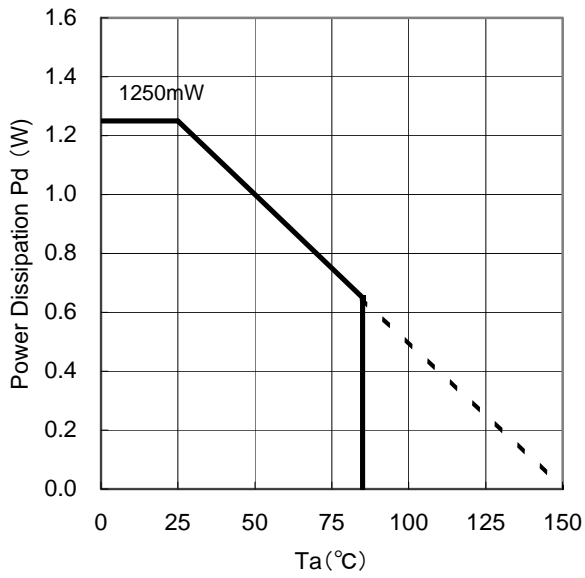

Information of the ROHM's standard board  
 Material : glass-epoxy  
 Size : 50mm×58mm×1.75mm (8Layer)  
 Pattern of the board: Refer to it that goes later.

●Ordering part number

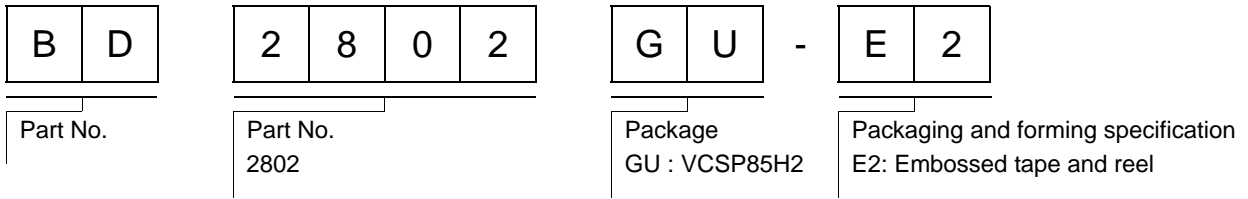

VCSP85H2 (BD2802GU)

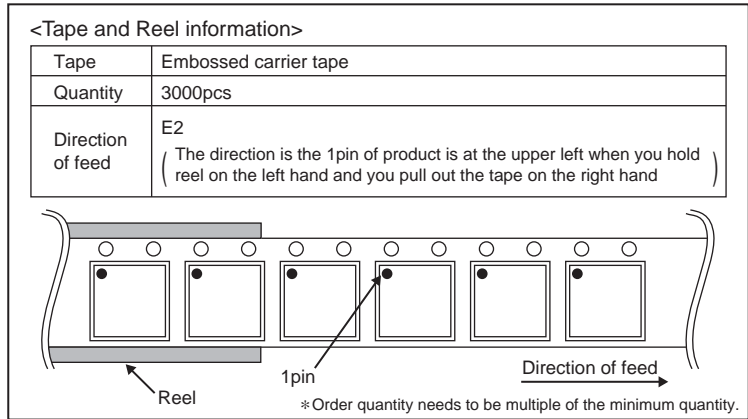
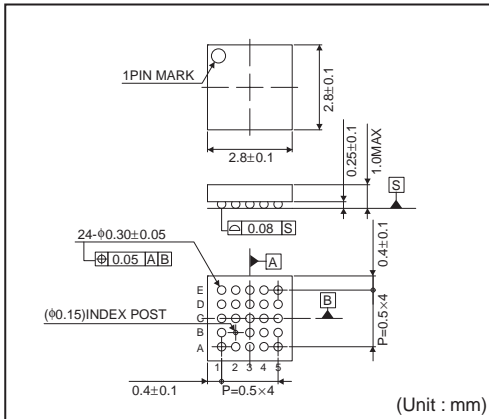

## Notes

No copying or reproduction of this document, in part or in whole, is permitted without the consent of ROHM Co.,Ltd.

The content specified herein is subject to change for improvement without notice.

The content specified herein is for the purpose of introducing ROHM's products (hereinafter "Products"). If you wish to use any such Product, please be sure to refer to the specifications, which can be obtained from ROHM upon request.

Examples of application circuits, circuit constants and any other information contained herein illustrate the standard usage and operations of the Products. The peripheral conditions must be taken into account when designing circuits for mass production.

Great care was taken in ensuring the accuracy of the information specified in this document. However, should you incur any damage arising from any inaccuracy or misprint of such information, ROHM shall bear no responsibility for such damage.

The technical information specified herein is intended only to show the typical functions of and examples of application circuits for the Products. ROHM does not grant you, explicitly or implicitly, any license to use or exercise intellectual property or other rights held by ROHM and other parties. ROHM shall bear no responsibility whatsoever for any dispute arising from the use of such technical information.

The Products specified in this document are intended to be used with general-use electronic equipment or devices (such as audio visual equipment, office-automation equipment, communication devices, electronic appliances and amusement devices).

The Products specified in this document are not designed to be radiation tolerant.

While ROHM always makes efforts to enhance the quality and reliability of its Products, a Product may fail or malfunction for a variety of reasons.

Please be sure to implement in your equipment using the Products safety measures to guard against the possibility of physical injury, fire or any other damage caused in the event of the failure of any Product, such as derating, redundancy, fire control and fail-safe designs. ROHM shall bear no responsibility whatsoever for your use of any Product outside of the prescribed scope or not in accordance with the instruction manual.

The Products are not designed or manufactured to be used with any equipment, device or system which requires an extremely high level of reliability the failure or malfunction of which may result in a direct threat to human life or create a risk of human injury (such as a medical instrument, transportation equipment, aerospace machinery, nuclear-reactor controller, fuel-controller or other safety device). ROHM shall bear no responsibility in any way for use of any of the Products for the above special purposes. If a Product is intended to be used for any such special purpose, please contact a ROHM sales representative before purchasing.

If you intend to export or ship overseas any Product or technology specified herein that may be controlled under the Foreign Exchange and the Foreign Trade Law, you will be required to obtain a license or permit under the Law.



Thank you for your accessing to ROHM product informations.  
More detail product informations and catalogs are available, please contact us.

## ROHM Customer Support System

<http://www.rohm.com/contact/>