

Series 02

Characteristics

The robust Series 02 is especially suited for:

- Flush design

The rectangular construction (24x36 mm) provides large surfaces for illumination and labelling.

Functions

The Series 02 incorporates the following functions:

- Indicator
- Pushbutton
- Illuminated pushbutton
- Keylock switch
- Buzzer

Market segments

The EAO Series 02 is especially suited for applications in the segments:

- Ship building
- Panel building

Please refer to the EAO website to obtain detailed information regarding this series www.products.eao.com
Configure a product to your exact needs and request a quotation.



Overview**Flush design**

| | |
|----------------------------------|----|
| Indicator | 4 |
| Buzzer | 5 |
| Pushbutton | 6 |
| Illuminated pushbutton | 7 |
| Mushroom-head pushbutton | 8 |
| Keylock switch | 9 |
| Mushroom-head keylock pushbutton | 10 |

Accessories 11**Technical data** 21**Marking** 23**Application guidelines** 24**Index** 25

02 Flush design

Indicator, IP 40



Product can differ from the current configuration.



Dimensions [mm]

Additional Information

- For front dimension 24 x 36 mm
- For indicator 02-07x.00x can only filament lamps be used (no LEDs)
- For LED element fitting information see chapter «Application guidelines»
- Take note of heat generating



Mounting cut-outs [mm]

Equipment consisting of (schematic overview)

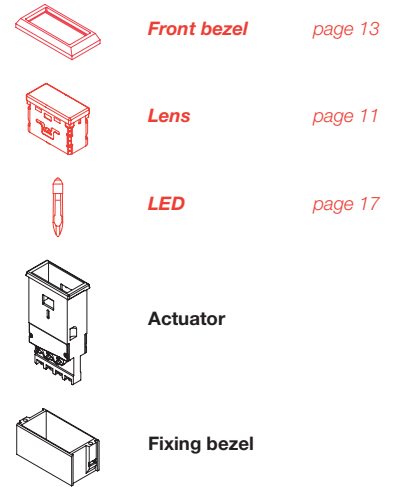

Each article number listed below includes all the black components shown in the 3D-drawing.

To obtain a complete unit, please select the red components from the pages shown.

| Product attribute | Behind panel depth | Terminal | Part No. | Wiring diagram | Weight |
|--|--------------------|----------|-------------------|----------------|----------|
|  <p>Indicator actuator without serie resistor, for LED or filament lamp</p> | 60 mm | Screw | 02-021.001 | 1 | 0.030 kg |
|  <p>Indicator actuator with built-in lamp series resistor, 240 VAC/DC to 48 V, 25 mA, for filament lamp</p> | 84 mm | Screw | 02-070.001 | 1 | 0.045 kg |
| with built-in lamp series resistor, 110 VAC/DC to 48 V, 25 mA, for filament lamp | 84 mm | Screw | 02-071.001 | 1 | 0.045 kg |
| with built-in lamp series resistor, 125 VAC/DC to 48 V, 25 mA, for filament lamp | 84 mm | Screw | 02-072.001 | 1 | 0.045 kg |
| with built-in lamp series resistor and diode, 240 VAC/DC to 48 V, 25 mA, for filament lamp | 84 mm | Screw | 02-073.001 | 1 | 0.045 kg |



Buzzer, IP 40

Equipment consisting of (schematic overview)



Front bezel page 13



Buzzer



Fixing bezel



Dimensions [mm]



Product can differ from the current configuration.

Each article number listed below includes all the black components shown in the 3D-drawing.

To obtain a complete unit, please select the red components from the pages shown.



Mounting cut-outs [mm]

Additional Information

- For front dimension 24 x 36 mm
- Further information in chapter «Technical Data»

| Operating voltage | Front cap | Terminal | Part No. | Wiring diagram | Weight |
|--|--------------|----------|-------------------|----------------|----------|
|  <p>Buzzer</p> | | | | | |
| 10 ... 55 VAC, 10 ... 75 VDC | Pastic black | Screw | 02-810.001 | 1 | 0.060 kg |



02 Flush design

Pushbutton, IP 40



Product can differ from the current configuration.



Dimensions [mm]

Additional Information

- For front dimension 24 x 36 mm



Mounting cut-outs [mm]

Equipment consisting of (schematic overview)



Front bezel page 13



Lens page 11



Actuator



Fixing bezel

Each article number listed below includes all the black components shown in the 3D-drawing.

To obtain a complete unit, please select the red components from the pages shown.

| Contacts | Switching action | Terminal | Part No. | Wiring diagram | Weight |
|----------|------------------|----------|-------------------|----------------|----------|
| | A | Screw | 02-611.011 | 1 | 0.045 kg |
| | C | Screw | 02-613.011 | 2 | 0.045 kg |
| 2 C | A | Screw | 02-612.011 | 3 | 0.050 kg |
| | C | Screw | 02-614.011 | 4 | 0.050 kg |
| | B - C | Screw | 02-615.011 | 5 | 0.050 kg |

Contacts: C = Changeover

Switching action: B = Momentary, C = Maintain



Illuminated pushbutton, IP 40

Equipment consisting of (schematic overview)



Front bezel page 13



Lens page 11



LED page 17



Actuator



Fixing bezel

Each article number listed below includes all the black components shown in the 3D-drawing.

To obtain a complete unit, please select the red components from the pages shown.



Dimensions [mm] [mm]



Mounting cut-outs [mm]

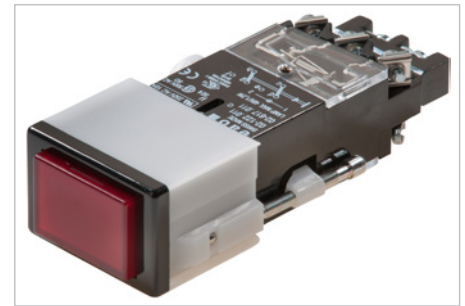

Product can differ from the current configuration.

Additional Information

- For front dimension 24 x 36 mm
- For LED element fitting information see chapter «Application guidelines»

| Contacts | Switching action | Terminal | Part No. | Wiring diagram | Gewicht |
|---|------------------|----------|-------------------|----------------|----------|
|  Illuminated pushbutton actuator | | | | | |
| 1 C | B | Screw | 02-616.011 | 1 | 0.050 kg |
| | C | Screw | 02-618.011 | 2 | 0.050 kg |
| 2 C | B | Screw | 02-617.011 | 3 | 0.055 kg |
| | C | Screw | 02-619.011 | 4 | 0.055 kg |
| | B - C | Screw | 02-620.011 | 5 | 0.055 kg |

Contacts: C = Changeover

Switching action: B = Momentary, C = Maintain

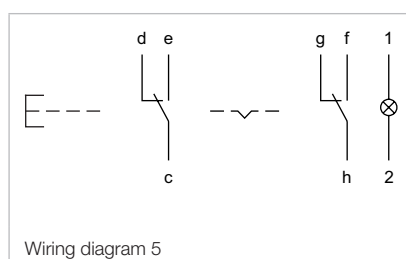

02 Flush design

Mushroom-head pushbutton, IP 40

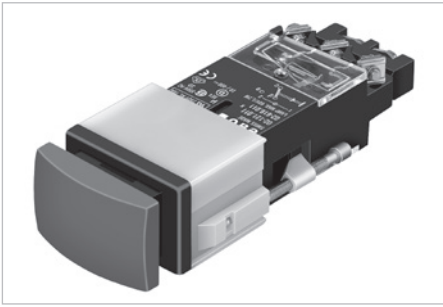

Product can differ from the current configuration.



Dimensions [mm]

Additional Information

- For front dimension 24 x 36 mm
- Use only flush front bezel



Mounting cut-outs[mm]

Equipment consisting of (schematic overview)



Mushroom-head cap page 11



Front bezel page 13



Actuator



Fixing sleeve

Each Part Number listed below includes all the black components shown in the 3D-drawing.

To obtain a complete unit, please select the red components from the pages shown.

| Contacts | Switching action | Terminal | Part No. | Wiring diagram | Weight |
|--|------------------|----------|-------------------|----------------|----------|
|  Mushroom-head pushbutton actuator | | | | | |
| 1 C | B | Screw | 02-611.011 | 1 | 0.045 kg |
| | C | Screw | 02-613.011 | 2 | 0.045 kg |
| 2 C | B | Screw | 02-612.011 | 3 | 0.050 kg |
| | C | Screw | 02-614.011 | 4 | 0.050 kg |
| | B - C | Screw | 02-615.011 | 5 | 0.050 kg |

Contacts: C = Changeover

Switching action: B = Momentary, C = Maintain



Keylock switch 2 positions, IP 40

Equipment consisting of (schematic overview)



Front bezel page 13



Keylock front bezel page 12



Actuator



Fixing bezel

Each article number listed below includes all the black components shown in the 3D-drawing.

To obtain a complete unit, please select the red components from the pages shown.



Dimensions [mm]



Product can differ from the current configuration.



Mounting cut-outs [mm]

Additional Information

- For front dimension 24 x 36 mm
- Front plastic grey
- Keylock number YB1
- After turning the key 90° clockwise, the switch can be operated
- In the unlocked switch positions always perform a momentary action
- Two keys are supplied with each key lock switch



Switching positions (A = Rest, B = Momentary)

| Product attribute | Contacts | Switching angle | Key remove | Terminal | Part No. | Wiring diagram | Gewicht |
|---|----------|-----------------|------------|----------|-------------------|----------------|----------|
|  | | | | | | | |
| Schlüsselschalter-Vorsatz 2 Stellungen | | | | | | | |
| A = lockable, actuated | 2 C | B = 90° | A | Screw | 02-690.011 | 1 | 0.055 kg |
| A = lockable, non-actuated or actuated | 2 C | B = 90° | A | Screw | 02-692.011 | 1 | 0.055 kg |
| A = lockable, non-actuated | 2 C | B = 90° | A | Screw | 02-691.011 | 1 | 0.055 kg |

Contacts: C = Changeover



02 Flush design

Keylock switch 2 positions, IP 40



Product can differ from the current configuration.



Dimensions [mm]

Additional Information

- For front dimension 24 x 36 mm
- Front plastic grey
- Keylock number YB1
- After turning the key 90° clockwise, the switch can be operated
- In the unlocked switch positions always perform a momentary action
- Two keys are supplied with each key lock switch



Mounting cut-outs [mm]

Equipment consisting of (schematic overview)



Each article number listed below includes all the black components shown in the 3D-drawing.

To obtain a complete unit, please select the red components from the pages shown.



Switching positions (A = Rest, B = Momentary)

| Product attribute | Contacts | Switching angle | Key remove | Terminal | Part No. | Wiring diagram | Gewicht |
|---|----------|-----------------|------------|----------|-------------------|----------------|----------|
|  | | | | | | | |
| Schlüsselschalter-Vorsatz 2 Stellungen | | | | | | | |
| A = lockable, non-actuated, B = lockable, key not removable | 2 C | B = 90° | A | Screw | 02-695.011 | 1 | 0.055 kg |
| A = lockable, non-actuated or actuated; can be used with protective cover Part No. 22-925 | 2 C | B = 90° | A | Screw | 02-198.011 | 1 | 0.055 kg |

Contacts: C = Changeover



Front

Lens

Additional Information

- Material plastic

| Product attribute | Dimension | Lens | Part No. | Weight | | |
|--|-----------------|--|--------------------|-------------------|-----------------|----------|
|  <p>Lens</p> | 17.5 x 25.4 mm | illuminative, not suitable for film insert, ripped | smoked translucent | 02-901.1 | 0.004 kg | |
| | | red translucent | 02-901.2 | 0.004 kg | | |
| | | orange translucent | 02-901.3 | 0.004 kg | | |
| | | yellow translucent | 02-901.4 | 0.004 kg | | |
| | | green translucent | 02-901.5 | 0.004 kg | | |
| | | blue translucent | 02-901.6 | 0.004 kg | | |
| | | colourless transparent | 02-901.7 | 0.004 kg | | |
| | | white translucent | 02-901.9 | 0.004 kg | | |
| | | illuminative, use holder for film insert | 17.5 x 25.4 mm | red translucent | 02-902.2 | 0.004 kg |
| | | | | green translucent | 02-902.5 | 0.004 kg |
| colourless transparent | 02-902.7 | | | 0.004 kg | | |
| non-illuminative | 17.5 x 25.4 mm | black opaque | 02-901.0 | 0.004 kg | | |
| | | grey opaque | 02-901.8 | 0.004 kg | | |

Keylock front bezel

Additional Information

- Keylock number YB1
- Further lock numbers see «Technical data»

| Product attribute | Dimension | Material | Colour | Part No. | Weight | |
|---|------------------------------------|----------------|---------|-----------------|-----------------|----------|
|  <p>Keylock front bezel</p> | 17.5 x 25.5 mm | Plastic | grey | 02-980.1 | 0.002 kg | |
| | for keylock switch Part No. 02-695 | 17.5 x 25.5 mm | Plastic | grey | 02-982.1 | 0.002 kg |

02 Accessories

Holder

Additional Information

- For lens with film insert

| Material | Colour | Optics | Part No. | Weight |
|---|------------|-------------|-----------------|----------|
|  Holder | | | | |
| Plastic | red | translucent | 02-908.2 | 0.001 kg |
| | orange | translucent | 02-908.3 | 0.001 kg |
| | yellow | translucent | 02-908.4 | 0.001 kg |
| | green | translucent | 02-908.5 | 0.001 kg |
| | blue | translucent | 02-908.6 | 0.001 kg |
| | colourless | transparent | 02-908.7 | 0.001 kg |
| | white | translucent | 02-908.9 | 0.001 kg |

Diffusor plate

Additional Information

- For lens with film insert

| Part No. | Weight |
|---|----------|
|  Diffusor plate | |
| 02-909 | 0.001 kg |

Front bezel flush

Additional Information

- Lens only removable with lens remover
Part No. 02-905

| Front bezel | Part No. | Weight |
|--|-----------------|----------|
|  Front bezel flush, Front dimension 24 x 36 mm | | |
| Pastic black | 02-965.0 | 0.001 kg |

Front bezel raised

Additional Information

- Lens only removable with lens remover
Part No. 98-969

| Front bezel | Part No. | Weight |
|--|-----------------|----------|
|  <p>Front bezel raised, Front dimension 24 x 36 mm</p> | | |
| Pastic black | 02-967.0 | 0.001 kg |

Protective cover, IP 65

Additional Information

- Please note that bigger minimum distances are necessary
- Use only flush front bezel
- Hinged, with means for sealing
- Front panel thickness reduces by 2 mm



Dimensions [mm]

| Product attribute | Material | Optics | Dimension | Part No. | Weight |
|--|----------|-------------|--------------|---------------|----------|
|  <p>Protective cover</p> | | | | | |
| for button with mounting cut-out 21.2 x 29.2 mm | Plastic | transparent | 36 x 29.7 mm | 22-925 | 0.004 kg |

02 Accessories

Spare key

Additional Information

- Keylock number YB1

| Part No. | Weight |
|---|----------|
|  <p>Spare key</p> | |
| 02-989.001 | 0.001 kg |

Front protective cap, IP 65

Additional Information

- Use only flush front bezel
- Three-part



Dimensions [mm]



Mounting cut-outs [mm]

| Material | Colour | Optics | Temperature | Part No. | Weight |
|--|------------|-------------|---------------|---------------|----------|
|  <p>Front protective cap</p> | | | | | |
| PVC | colourless | transparent | -20 ... +60 ° | 02-924 | 0.005 kg |
| | | | -25 ... +85 ° | 02-935 | 0.005 kg |

Blind plug



Mounting cut-outs [mm]

| Dimension | Material | Colour | Part No. | Weight |
|--|----------|--------|-----------------|----------|
|  <p>Blind plug</p> | Plastic | black | 02-949.0 | 0.004 kg |
| | | grey | 02-949.8 | 0.004 kg |

02 Accessories

Backside

Terminal cover

Additional Information

- For all connection methods
- Not suitable for indicators with built-in series resistor with lamp

| Part No. | Weight |
|---|----------|
|  Terminal cover | |
| 02-929 | 0.005 kg |

Illumination

Single-LED, T6.8

Additional Information

- For LED element fitting information see «Application guidelines»
- Due to high surface temperatures, the series resistor must not be soldered directly to the terminals of the equipment (use a terminal plate)
- When using AC/DC types with AC operation, slight flickering can occur
- Luminous intensity data of the LEDs on direct voltage
- Electrical and optical data are measured at 25 °C
- The specified versions are built with a protection diode (half wave rectifier) in series and the LED
- Luminosity and wave length variations caused by LED manufacturing processes may cause slight differences regarding the illumination
- For supply voltages above 48 V, it is necessary to use a voltage reduction element (external series resistor or transformer)



Dimensions [mm]

| LED colour | Operating voltage | Operation current | Lumi. intensity | Dom. wavelength | Part No. | Weight |
|--|-------------------|-------------------|-----------------|-----------------|---------------------|----------|
|  <p>Single-LED</p> | | | | | | |
| red | 6 VDC | 17 mA ±15 % | 400 mcd | 630 nm | 10-2K06.3152 | 0.002 kg |
| | 12 VAC/DC | 9/17 mA ±15 % | 400 mcd | 630 nm | 10-2K09.1072 | 0.002 kg |
| | 24 VAC/DC | 9/17 mA ±15 % | 400 mcd | 630 nm | 10-2K12.1072 | 0.002 kg |
| | 28 VAC/DC | 9/17 mA ±15 % | 400 mcd | 630 nm | 10-2K13.1072 | 0.002 kg |
| | 48 VAC/DC | 4/8 mA ±15 % | 200 mcd | 630 nm | 10-2K19.1052 | 0.002 kg |
| yellow | 6 VDC | 17 mA ±15 % | 340 mcd | 340 nm | 10-2K06.3154 | 0.002 kg |
| | 12 VAC/DC | 9/17 mA ±15 % | 340 mcd | 340 nm | 10-2K09.1074 | 0.002 kg |
| | 24 VAC/DC | 9/17 mA ±15 % | 340 mcd | 340 nm | 10-2K12.1074 | 0.002 kg |
| | 28 VAC/DC | 9/17 mA ±15 % | 340 mcd | 340 nm | 10-2K13.1074 | 0.002 kg |
| | 48 VAC/DC | 4/8 mA ±15 % | 180 mcd | 340 nm | 10-2K19.1054 | 0.002 kg |
| green | 6 VDC | 7 mA ±15 % | 1050 mcd | 525 nm | 10-2K06.3155 | 0.002 kg |
| | 12 VAC/DC | 4/7 mA ±15 % | 1050 mcd | 525 nm | 10-2K09.1075 | 0.002 kg |
| | 24 VAC/DC | 4/7 mA ±15 % | 1050 mcd | 525 nm | 10-2K12.1075 | 0.002 kg |
| | 28 VAC/DC | 4/7 mA ±15 % | 1050 mcd | 525 nm | 10-2K13.1075 | 0.002 kg |
| | 48 VAC/DC | 2/4 mA ±15 % | 600 mcd | 525 nm | 10-2K19.1055 | 0.002 kg |
| blue | 6 VDC | 17 mA ±15 % | 780 mcd | 470 nm | 10-2K06.3156 | 0.002 kg |
| | 12 VAC/DC | 9/17 mA ±15 % | 780 mcd | 470 nm | 10-2K09.1076 | 0.002 kg |
| | 24 VAC/DC | 9/17 mA ±15 % | 780 mcd | 470 nm | 10-2K12.1076 | 0.002 kg |
| | 28 VAC/DC | 9/17 mA ±15 % | 780 mcd | 470 nm | 10-2K13.1076 | 0.002 kg |
| | 48 VAC/DC | 4/8 mA ±15 % | 400 mcd | 470 nm | 10-2K19.1056 | 0.002 kg |

02 Accessories

| LED colour | Operating voltage | Operation current | Lumi. intensity | Dom. wavelength | Part No. | Weight |
|------------|-------------------|---------------------|-----------------|-----------------|---------------------|----------|
| white | 6 VDC | 6 mA \pm 15 % | 900 mcd | x0.31/y0.32 nm | 10-2K06.3159 | 0.002 kg |
| | 12 VAC/DC | 3/6 mA \pm 15 % | 900 mcd | x0.31/y0.32 nm | 10-2K09.1079 | 0.002 kg |
| | 24 VAC/DC | 3/6 mA \pm 15 % | 900 mcd | x0.31/y0.32 nm | 10-2K12.1079 | 0.002 kg |
| | 28 VAC/DC | 2.5/5 mA \pm 15 % | 750 mcd | x0.31/y0.32 nm | 10-2K13.1079 | 0.002 kg |
| | 48 VAC/DC | 2/4 mA \pm 15 % | 600 mcd | x0.31/y0.32 nm | 10-2K19.1059 | 0.002 kg |

Filament lamp, T6.8

| Operating voltage | Operation current | Part No. | Weight |
|--|-------------------|---------------------|----------|
|  <p>Filament lamp</p> | | | |
| 12 VAC/DC | 50 mA \pm 10 % | 10-1209.1279 | 0.001 kg |
| 12 VAC/DC | 100 mA \pm 10 % | 10-1209.1329 | 0.001 kg |
| 24 VAC/DC | 25 mA \pm 10 % | 10-1212.1199 | 0.001 kg |
| 24 VAC/DC | 50 mA \pm 10 % | 10-1212.1279 | 0.001 kg |
| 28 VAC/DC | 40 mA \pm 10 % | 10-1213.1249 | 0.001 kg |
| 30 VAC/DC | 40 mA \pm 10 % | 10-1214.1249 | 0.001 kg |
| 36 VAC/DC | 35 mA \pm 10 % | 10-1216.1229 | 0.001 kg |

Series resistor

Additional Information

- For filament lamp 48 VAC, 25 mA
- For lamp voltage reduction
- Keep to the country specific safety instructions
- Due to high surface temperatures, the series resistor must not be soldered directly to the terminals of the equipment (use a terminal plate)

| Operating voltage | Resistance | Part No. | Weight |
|--|------------|-----------------|----------|
|  <p>Series resistor</p> | | | |
| 110 VAC | 2.7 kOhm | 02-904.0 | 0.003 kg |
| 125 VAC | 3.3 kOhm | 02-904.1 | 0.003 kg |
| 145 VAC | 4.7 kOhm | 02-904.3 | 0.003 kg |
| 240 VAC | 10 kOhm | 02-904.7 | 0.003 kg |

Terminal plate empty

Additional Information



- For fitting with series resistors

| Product attribute | Dimension | Part No. | Weight |
|--|--------------------|-----------------|----------|
|  <p>Terminal plate empty</p> | | | |
| 5 spaces | 62.5 x 60 x 15 mm | 02-912.1 | 0.025 kg |
| 10 spaces | 125 x 60 x 15 mm | 02-912.2 | 0.045 kg |
| 15 spaces | 187.6 x 60 x 15 mm | 02-912.3 | 0.090 kg |
| 20 spaces | 250 x 60 x 15 mm | 02-912.4 | 0.095 kg |

02 Accessories

Mounting



Lens remover

| Product attribute | Part No. | Weight |
|---|---------------|----------|
|  Lens remover | | |
| for flush front bezel | 02-905 | 0.011 kg |
|  Lens remover | | |
| for raised front bezel | 98-968 | 0.004 kg |

Lamp remover

Additional Information

▲ **Vorsicht:** A switching process might be released when replacing the lamp

| Product attribute | Part No. | Weight |
|---|------------------|----------|
|  Lamp remover | | |
| for LED | 03-996 | 0.027 kg |
|  Lamp remover | | |
| for filament lamp | 61-9740.0 | 0.003 kg |

Actuator with snap-action switching element
Switching system

1 or 2 self-cleaning, snap-action switching elements.
1 or 2 double-throw contacts.

Material
Material of contact

Standard version:
Silver (U > 20V)
Special versions: (on request)
Gold/Silver 700Au/300Ag (U < 50V)
Silver/Palladium 700Ag/300Pd (U > 20V) for atmospheres containing sulphur

Switch housing

Thermosetting material, heat-resistant

Indicator housing with reduced length

Polyamide

Mechanical characteristics
Terminals

Screw terminal (with self-lifting clip):
max. wire cross-section, 2 x 2.5 mm²
max. wire cross-section of stranded cable, 2 x 1.5 mm²

Tightening torque

For fixing sleeve max. 20Ncm
For screw terminal max. 80Ncm

Actuating force

6N ... 12N

Actuating travel

5mm

Mechanical lifetime

Momentary action 2 million operations
Maintained action 1 million operations

Electrical characteristics
Standards

The switches comply with the "Standards for low-voltage switching devices" IEC 60947-5-1

Rated insulation voltage

400VAC/440VDC, as per IEC 60947-5-1

Conventional free air thermal current

10A

The maximum current in continuous operation and at ambient temperature not exceeding the quoted maximum values.

Switch rating

400VAC, 10A, cosφ 0.95, as per IEC 60947-5-1
250VAC, 10A, as per UL

Electric strength

2500VAC, 50Hz, 1 min. between all terminals and earth, as per IEC 60947-5-1

Environmental conditions
Storage temperature

-30°C ... +85°C

Service temperature

-25°C ... +55°C

For indicators and illuminated pushbuttons mounted as a block, make sure the heat can escape freely.

Protection degree

Front side IP 40, IP 65 with spray cover, as per IEC 60529

Shock resistance

15g for 11 ms, as per IEC 60068-2-27

Vibration resistance

10g at 10 ... 2000Hz, amplitude 1.0mm, as per IEC 60068-2-6

Approvals
Approbations

CB (IEC 60947-5-1)
CSA
Germanischer Lloyd
UL

Declaration of conformity

CE

02 Technical data

Buzzer

Buzzer system

System

Electronic non-contacting buzzer with IC oscillator

Material

Buzzer case

Thermosetting material

Front cap

Polycarbonate (PC)

Front bezel

Polymethylacrylate

Mechanical characteristics

Terminals

Screw terminal

Tightening torque

For fixing sleeve max. 20Ncm

For screw terminal max. 80Ncm

Electrical characteristics

Frequency (tone)

Approx. 2.8 kHz

Sound pressure

85 dB (A) ± 8 dB at a distance of 0.1 m

Volume variable with a M Ω potentiometer or corresponding fixed resistor

Operation Voltage/Current

typical

10 ... 55 VAC 10 ... 75 VDC

25 mA 15 mA

Environmental conditions

Storage temperature

-40 °C ... +85 °C

Operating temperature

-25 °C ... +55 °C

Protection degree

Front side IP 40, as per IEC 60529

Approvals

Approbations

CB (IEC 60947-5-1)

Declaration of conformity

CE

EAO reserves the right to alter specifications without further notice.

General notes

1. Engraving

In addition to the most commonly used world languages, in DIN1451-3 close spacing, other typefaces are available as Scandinavian, Slavic, Greek, Russian and Polish. Red, blue and black lenses are filled with white colour. Other colour lenses are filled in black. Standard height of letters is 3 mm. If the height is not specified, we will supply 3 mm engraved letters.

2. Hot stamping

For larger series it is worth considering markings by means of hot stamping. We will pleased to advise you. For letters and figures, typefaces with 2.5 mm, 3 mm and 4 mm are available.

3. Film inserts

Instead of using engraving the lenses can be fitted with transparent film inserts, as an alternative. For this purpose, though, it is advisable to use lenses without ripped pattern. In the case of use of a smoke-black lens the fitted film becomes readable only if the lamp is on. The film (F) is inserted in the cap. To ensure even illumination a diffusor (D) is recommended, which is inserted beneath the film. If, on the other hand, the diffusor is inserted above the film, the lettering only becomes legible when the lamp is alight. To hold the film and diffusor in position, the use of a holder (N) is advised. The film thickness is 0.2 mm.

All dimensions in mm

| Film insert max. size | Height of letters h | Number of lines | Number of capital letters per line (target value) | Number of small letters per line (target value) | Image |
|-----------------------|---------------------|-----------------|---|---|-------|
| 14.3 x 22.4 | 3 | 4 | 11 | 13 | B1 |
| | | | 7-8 | 8-9 | B2 |
| | 4 | 2 | 7 | 9 | B1 |
| | | | 4 | 5-6 | B2 |
| | 5 | 2 | 5-6 | 6-7 | B1 |
| | | | 3 | 4 | B2 |
| | 6 | 1 | 5 | 6 | B1 |
| | | | 3 | 4 | B2 |
| | 8 | 1 | 3 | 4 | B1 |
| | | | 2 | 2 | B2 |

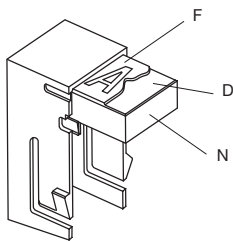

B1



B2



02 Application guidelines

Suppressor circuits

When switching inductive loads such as relays, DC motors, and DC solenoids, it is always important to absorb surges (e.g. with a diode) to protect the contacts. When these inductive loads are switched off, a counter emf can severely damage switch contacts and greatly shorten lifetime.

Fig. 1 shows an inductive load with a free-wheeling diode connected in parallel. This free-wheeling diode provides a path for the inductor current to flow when the current is interrupted by the switch. Without this free-wheeling diode, the voltage across the coil will be limited only by dielectric breakdown voltages of the circuit or parasitic elements of the coil. This voltage can be kilovolts in amplitude even when nominal circuit voltages are low (e.g. 12VDC) see Fig. 2.

The free-wheeling diode should be chosen so that the reverse breakdown voltage is greater than the voltage driving the inductive load. The DC blocking voltage (V_R) of the free-wheeling diode can be found in the datasheet of a diode. The forward current should be equal or greater than the maximum current flowing through the load.

To get an efficient protection, the free-wheeling diode must be connected as close as possible to the inductive load!

Switching with inductive load
Fig. 1



Counter EMF
over load without free-wheeling diode
Fig. 2



LED polarity

When fitting the LED element the polarity has to correspond with the respective terminal, (+) goes to +.



Index from Part No.

| <u>Part No.</u> | <u>Page</u> | <u>Part No.</u> | <u>Page</u> |
|--------------------|-------------|-------------------|-------------|
| 02-021.001 | 4 | 10-2K06.3159..... | 18 |
| 02-070.001 | 4 | 10-2K09.1072..... | 17 |
| 02-071.001 | 4 | 10-2K09.1074..... | 17 |
| 02-072.001 | 4 | 10-2K09.1075..... | 17 |
| 02-073.001 | 4 | 10-2K09.1076..... | 17 |
| 02-198.011 | 10 | 10-2K09.1079..... | 18 |
| 02-611.011 | 6 | 10-2K12.1072..... | 17 |
| 02-611.011 | 8 | 10-2K12.1074..... | 17 |
| 02-612.011 | 6 | 10-2K12.1075..... | 17 |
| 02-612.011 | 8 | 10-2K12.1076..... | 17 |
| 02-613.011 | 6 | 10-2K12.1079..... | 18 |
| 02-613.011 | 8 | 10-2K13.1072..... | 17 |
| 02-614.011 | 6 | 10-2K13.1074..... | 17 |
| 02-614.011 | 8 | 10-2K13.1075..... | 17 |
| 02-615.011 | 6 | 10-2K13.1076..... | 17 |
| 02-615.011 | 8 | 10-2K13.1079..... | 18 |
| 02-616.011 | 7 | 10-2K19.1052..... | 17 |
| 02-617.011 | 7 | 10-2K19.1054..... | 17 |
| 02-618.011 | 7 | 10-2K19.1055..... | 17 |
| 02-619.011 | 7 | 10-2K19.1056..... | 17 |
| 02-620.011 | 7 | 10-2K19.1059..... | 18 |
| 02-690.011 | 9 | 22-925 | 13 |
| 02-691.011 | 9 | 61-9740.0 | 20 |
| 02-692.011 | 9 | 98-968 | 20 |
| 02-695.011 | 10 | | |
| 02-810.001 | 5 | | |
| 02-901.0 | 11 | | |
| 02-901.1 | 11 | | |
| 02-901.2 | 11 | | |
| 02-901.3 | 11 | | |
| 02-901.4 | 11 | | |
| 02-901.5 | 11 | | |
| 02-901.6 | 11 | | |
| 02-901.7 | 11 | | |
| 02-901.8 | 11 | | |
| 02-901.9 | 11 | | |
| 02-902.2 | 11 | | |
| 02-902.5 | 11 | | |
| 02-902.7 | 11 | | |
| 02-904.0 | 18 | | |
| 02-904.1 | 18 | | |
| 02-904.3 | 18 | | |
| 02-904.7 | 18 | | |
| 02-905 | 20 | | |
| 02-908.2 | 12 | | |
| 02-908.3 | 12 | | |
| 02-908.4 | 12 | | |
| 02-908.5 | 12 | | |
| 02-908.6 | 12 | | |
| 02-908.7 | 12 | | |
| 02-908.9 | 12 | | |
| 02-909 | 12 | | |
| 02-912.1 | 19 | | |
| 02-912.2 | 19 | | |
| 02-912.3 | 19 | | |
| 02-912.4 | 19 | | |
| 02-924 | 14 | | |
| 02-929 | 16 | | |
| 02-935 | 14 | | |
| 02-949.0 | 15 | | |
| 02-949.8 | 15 | | |
| 02-965.0 | 13 | | |
| 02-967.0 | 13 | | |
| 02-980.1 | 12 | | |
| 02-989.001 | 14 | | |
| 03-996 | 20 | | |
| 10-1209.1279 | 18 | | |
| 10-1209.1329 | 18 | | |
| 10-1212.1199 | 18 | | |
| 10-1212.1279 | 18 | | |
| 10-1213.1249 | 18 | | |
| 10-1214.1249 | 18 | | |
| 10-1216.1229 | 18 | | |
| 10-2K06.3152..... | 17 | | |
| 10-2K06.3154..... | 17 | | |
| 10-2K06.3155..... | 17 | | |
| 10-2K06.3156..... | 17 | | |

