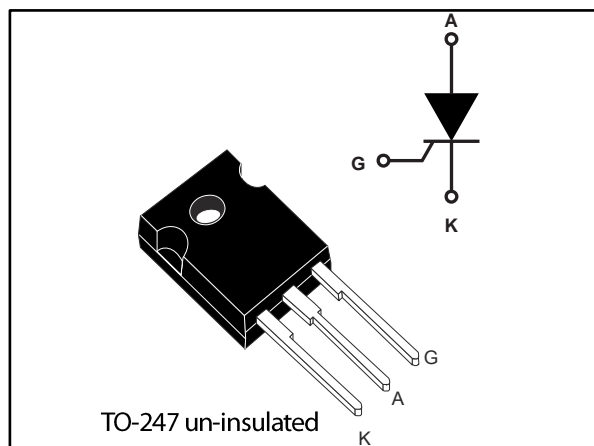

50 A - 1200 V automotive grade SCR Thyristor

Datasheet - production data

Description

Available in TO-247 high power package, the TN5050H-12WY autograde is suitable in applications such as automotive / stationary battery charger, renewable energy generator, interruptible power supply, solid state relay, welding equipment and motor drive applications.

Its power switching, voltage robustness and power dissipation performances are the key features for functions such as a 80 A AC switch, an AC phasing inverter and an AC-DC controlled rectifier bridge.

The TN5050H-12WY is an automotive grade product and offers a superior performance in surge current handling, thermal cooling capabilities and overvoltage robustness.

Features

- AEC-Q101 qualified
- On-state current: 50 A_{RMS}
- Blocking voltage: +/- 1200 V
- High static and dynamic commutation:
 - $di/dt = 200 \text{ A}/\mu\text{s}$
 - $dV/dt = 1000 \text{ V}/\mu\text{s}$
- $I_{GT} = 50 \text{ mA}$
- ECOPACK[®]2 compliant component

Applications

- Automotive
 - On board, off board battery charger
- Solar, wind renewable energy inverters
- Solid state relays
- UPS
 - Bypass
 - ICL (inrush current limiter)
 - Battery charger
- Industrial welding systems
- Voltage control rectifier

Table 1: Device summary

Symbol	Value
$I_{T(RMS)}$	50 A
V_{DRM}/V_{RRM}	1200 V
V_{DSM}/V_{RSM}	1300 V
I_{GT}	50 mA
T_j	150 °C

1 Characteristics

Table 2: Absolute ratings (limiting values, $T_j = 25\text{ °C}$ unless otherwise stated)

Symbol	Parameter		Value	Unit	
V_{DRM} / V_{RRM}	Repetitive off-state voltage (50-60 Hz)		$T_j = 150\text{ °C}$ 1200	V	
$I_{T(RMS)}$	RMS on-state current (180 ° conduction angle)		$T_C = 137\text{ °C}$ 50	A	
$I_{T(AV)}$	Average on-state current (180 ° conduction angle)				
$I_{T(RMS)}$	RMS on-state current (180 ° conduction angle)		$T_C = 125\text{ °C}$ 80	A	
$I_{T(AV)}$	Average on-state current (180 ° conduction angle)				
$I_{TSM}^{(1)}$	Non repetitive surge peak on-state current, T_j initial = 25 °C		$t_p = 8.3\text{ ms}$	633	A
			$t_p = 10\text{ ms}$	580	
di/dt	Critical rate of rise of on-state current $I_G = 2 \times I_{GT}$, $t_r \leq 100\text{ ns}$	$f = 50\text{ Hz}$	$T_j = 150\text{ °C}$ 200	A/ μ s	
I_{GM}	Peak forward gate current	$T_j = 150\text{ °C}$	$t_p = 20\text{ }\mu$ s	8	A
$P_{G(AV)}$	Average gate power dissipation		$T_j = 150\text{ °C}$ 1	W	
T_{stg}	Storage junction temperature range			-40 to +150	°C
T_j	Operating junction temperature			-40 to +150	°C

Notes:

⁽¹⁾ST recommend I^2t value for fusing = 1680 A²s for $T_j = 25\text{ °C}$ and $t_p = 10\text{ ms}$

Table 3: Electrical characteristics ($T_j = 25\text{ °C}$ unless otherwise specified)

Symbol	Test Conditions		Value	Unit	
I_{GT}	$V_D = 12\text{ V}$, $R_L = 33\ \Omega$	Min.	10	mA	
		Max.	50		
V_{GT}	$V_D = 12\text{ V}$, $R_L = 33\ \Omega$	Max.	1	V	
V_{GD}	$V_D = 2/3 \times V_{DRM}$, $R_L = 3.3\text{ k}\Omega$	$T_j = 150\text{ °C}$	Min.	0.15	V
I_H	$I_T = 500\text{ mA}$, gate open		Max.	100	mA
I_L	$I_G = 1.2 \times I_{GT}$		Max.	125	mA
t_{gt}	$I_T = 50\text{ A}$, $V_D = V_{DRM}$, $I_G = 200\text{ mA}$, $di_G/dt = 0.2\text{ A}/\mu\text{s}$		Typ.	3	μs
dV/dt	$V_D = 2/3 \times V_{DRM}$, gate open	$T_j = 150\text{ °C}$	Min.	1000	$\text{V}/\mu\text{s}$
t_q	$I_T = 33\text{ A}$, $V_D = 800\text{ V}$, $V_R = 75\text{ V}$, $t_P = 100\ \mu\text{s}$, $di_T/dt = 10\text{ A}/\mu\text{s}$, $dV_D/dt = 20\text{ V}/\mu\text{s}$,	$T_j = 150\text{ °C}$	Typ.	150	μs
V_{TM}	$I_{TM} = 100\text{ A}$, $t_P = 380\ \mu\text{s}$		Max.	1.55	V
V_{TO}	Threshold voltage	$T_j = 150\text{ °C}$	Max.	0.88	V
R_D	Dynamic resistance	$T_j = 150\text{ °C}$	Max.	6	$\text{m}\Omega$
I_{DRM}/I_{RRM}	$V_D = V_{DRM}$, $V_R = V_{RRM}$	$T_j = 25\text{ °C}$	Max.	5	μA
		$T_j = 125\text{ °C}$	Max.	3	mA
		$T_j = 150\text{ °C}$	Max.	7.5	mA
I_{DSM}/I_{RSM}	$V_D = V_{DSM}$, $V_R = V_{RSM}$	$T_j = 25\text{ °C}$	Max.	10	μA

Table 4: Thermal parameters

Symbol	Parameter	Value	Unit
$R_{th(j-c)}$	Junction to case (DC, max.)	0.3	$^{\circ}\text{C}/\text{W}$
$R_{th(j-a)}$	Junction to ambient	50	$^{\circ}\text{C}/\text{W}$

1.1 Characteristics (curves)

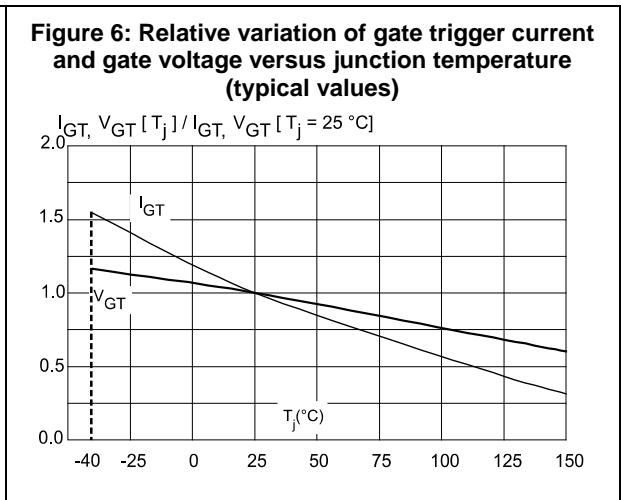
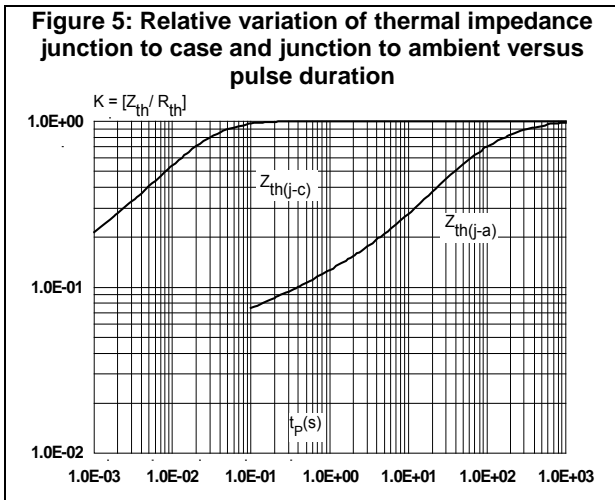
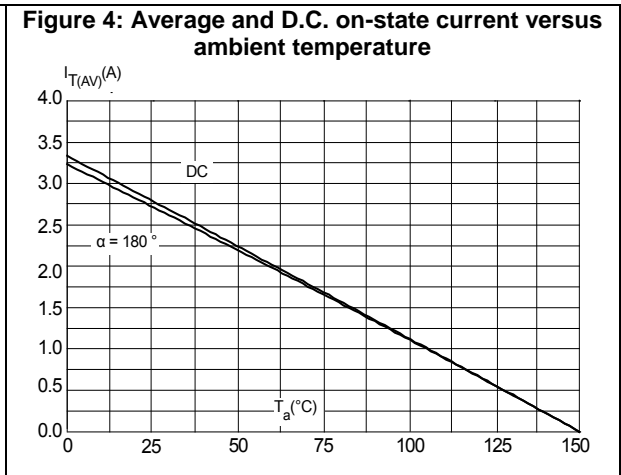
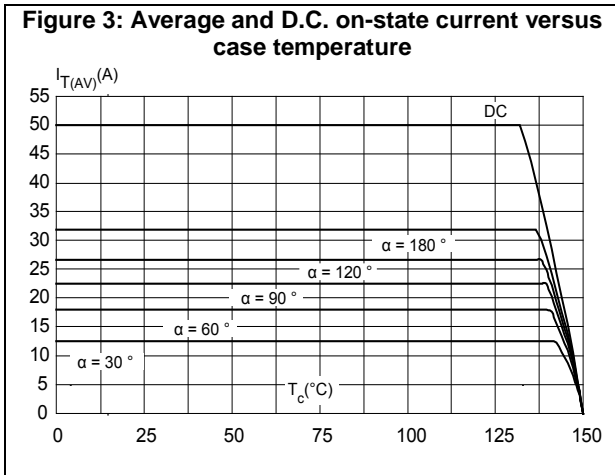
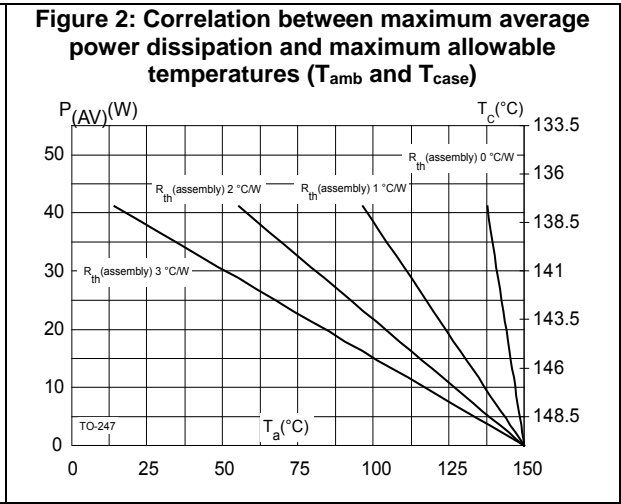
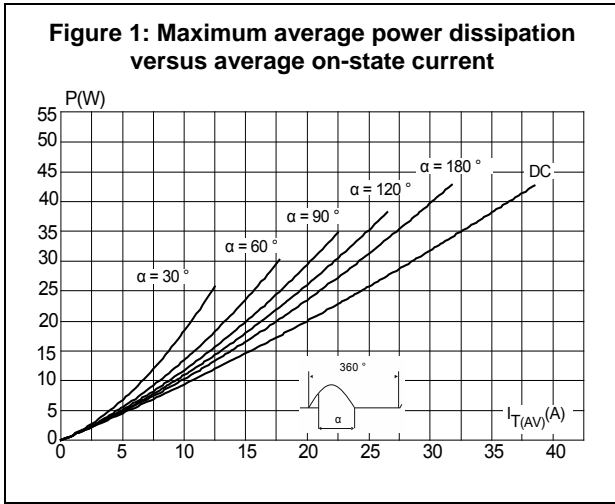

Figure 7: Relative variation of holding and latching current versus junction temperature (typical values)

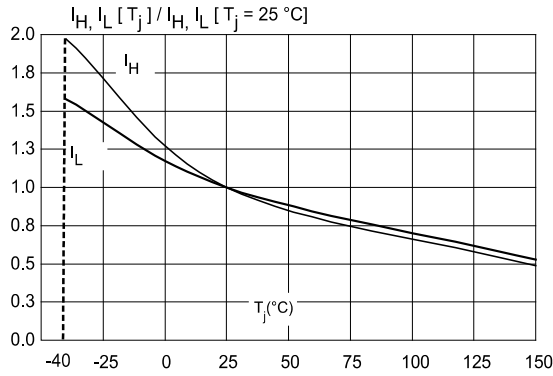

Figure 8: Surge peak on-state current versus number of cycles

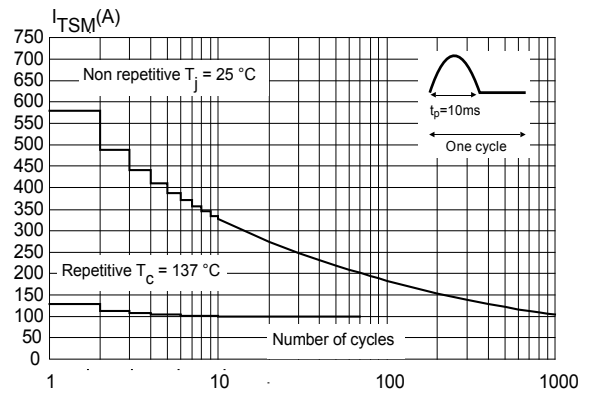

Figure 9: Non repetitive surge peak on-state current for a sinusoidal pulse ($t_p < 10\text{ ms}$)

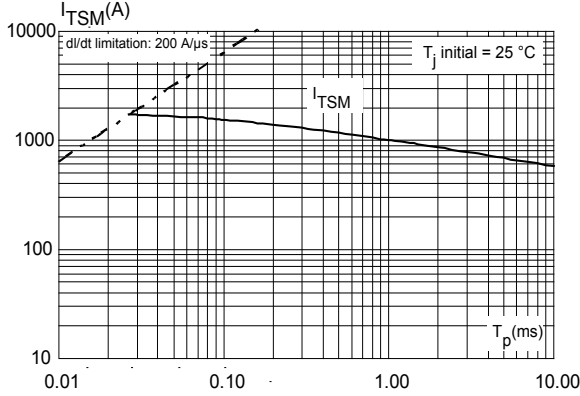

Figure 10: On-state characteristics (maximum values)

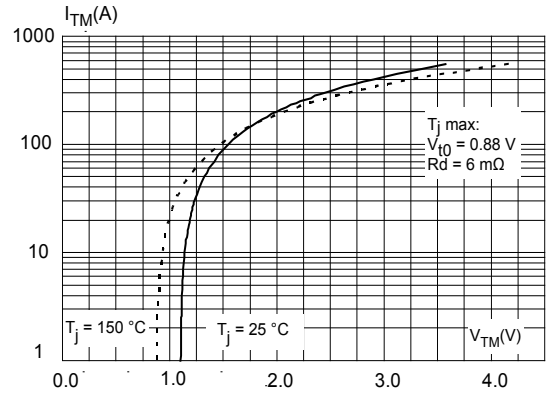
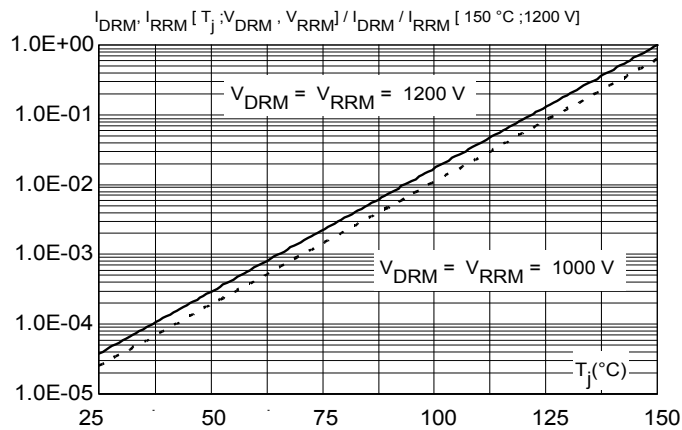

Figure 11: Relative variation of leakage current versus junction temperature for different values of blocking voltage (typical values)



2 Package information

In order to meet environmental requirements, ST offers these devices in different grades of ECOPACK® packages, depending on their level of environmental compliance. ECOPACK® specifications, grade definitions and product status are available at: www.st.com. ECOPACK® is an ST trademark.

- Epoxy meets UL94, V0
- Lead-free package

2.1 TO-247 package information

Figure 12: TO-247 package outline

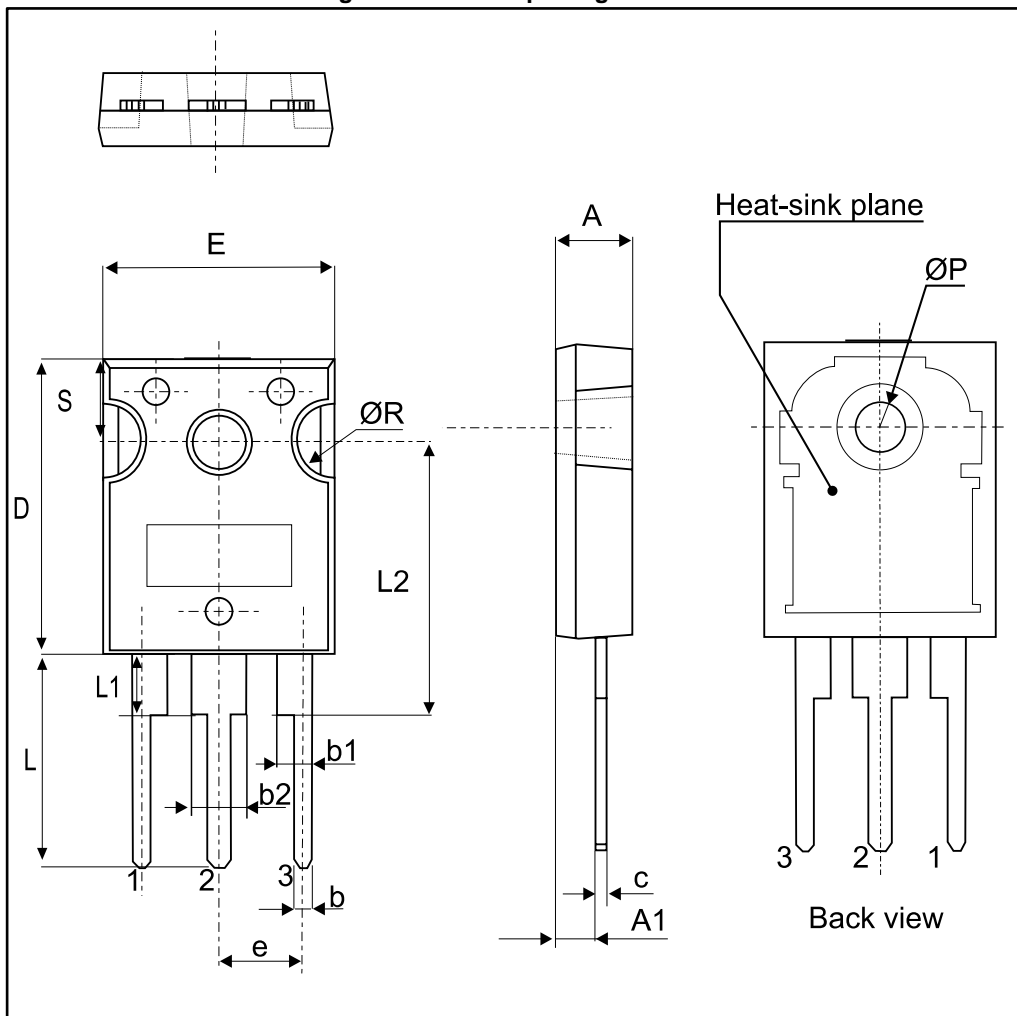

Table 5: TO-247 package mechanical data

Ref.	Dimensions					
	Millimeters			Inches ⁽¹⁾		
	Min.		Max.	Min.		Max.
A	4.85		5.15	0.1909		0.2028
A1	2.20		2.60	0.0866		0.1024
b	1.00		1.40	0.0394		0.0551
b1	2.00		2.40	0.0787		0.0945
b2	3.00		3.40	0.1181		0.1339
c	0.40		0.80	0.0157		0.0315
D ⁽²⁾	19.85		20.15	0.7815		0.7933
E	15.45		15.75	0.6083		0.6201
e	5.30	5.45	5.60	0.2087	0.2146	0.2205
L	14.20		14.80	0.5591		0.5827
L1	3.70		4.30	0.1457		0.1693
L2	18.50 typ.			0.7283 typ.		
ØP ⁽³⁾	3.55		3.65	0.1398		0.1437
ØR	4.50		5.50	0.1772		0.2165
S	5.30	5.50	5.70	0.2087	0.2165	0.2244

Notes:

⁽¹⁾Inches dimensions given for reference only

⁽²⁾Dimension D plus gate protrusion does not exceed 20.5 mm

⁽³⁾Resin thickness around the mounting hole is not less than 0.9 mm.

3 Ordering information

Table 6: Ordering information

Order code	Marking	Package	Weight	Base qty.	Delivery mode
TN5050H-12WY	TN5050H12Y	TO-247	4.43 g	30	Tube

4 Revision history

Table 7: Document revision history

Date	Revision	Changes
07-Jan-2015	1	Initial release.
17-Oct-2017	2	Updated TO-247 package information.
20-Dec-2017	3	Updated Table 5: "TO-247 package mechanical data" .

IMPORTANT NOTICE – PLEASE READ CAREFULLY

STMicroelectronics NV and its subsidiaries ("ST") reserve the right to make changes, corrections, enhancements, modifications, and improvements to ST products and/or to this document at any time without notice. Purchasers should obtain the latest relevant information on ST products before placing orders. ST products are sold pursuant to ST's terms and conditions of sale in place at the time of order acknowledgement.

Purchasers are solely responsible for the choice, selection, and use of ST products and ST assumes no liability for application assistance or the design of Purchasers' products.

No license, express or implied, to any intellectual property right is granted by ST herein.

Resale of ST products with provisions different from the information set forth herein shall void any warranty granted by ST for such product.

ST and the ST logo are trademarks of ST. All other product or service names are the property of their respective owners.

Information in this document supersedes and replaces information previously supplied in any prior versions of this document.

© 2017 STMicroelectronics – All rights reserved