

THIS DOCUMENT IS THE PROPERTY OF
KEYSTONE ELECTRONICS CORP. AND
SHALL NOT BE REPRODUCED, DISTRIBUTED
OR USED AS A BASIS FOR MANUFACTURE
WITHOUT PRIOR WRITTEN PERMISSION
FROM KEYSTONE ELECTRONICS CORP.

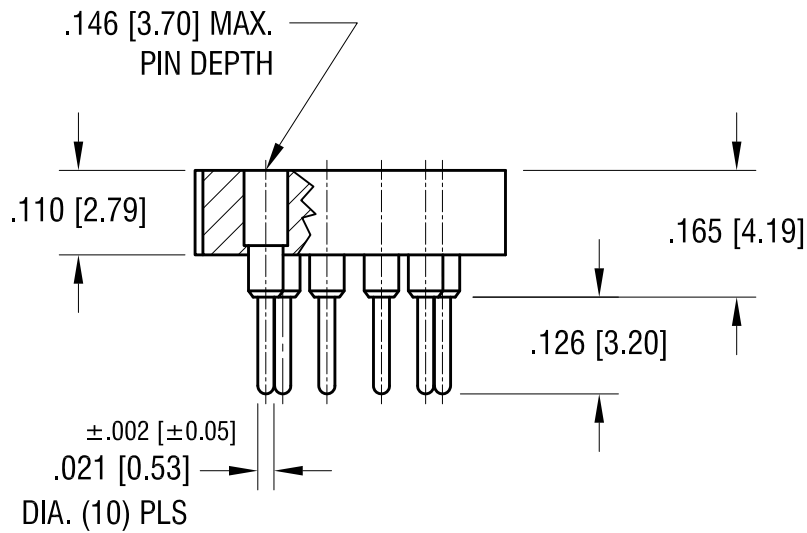
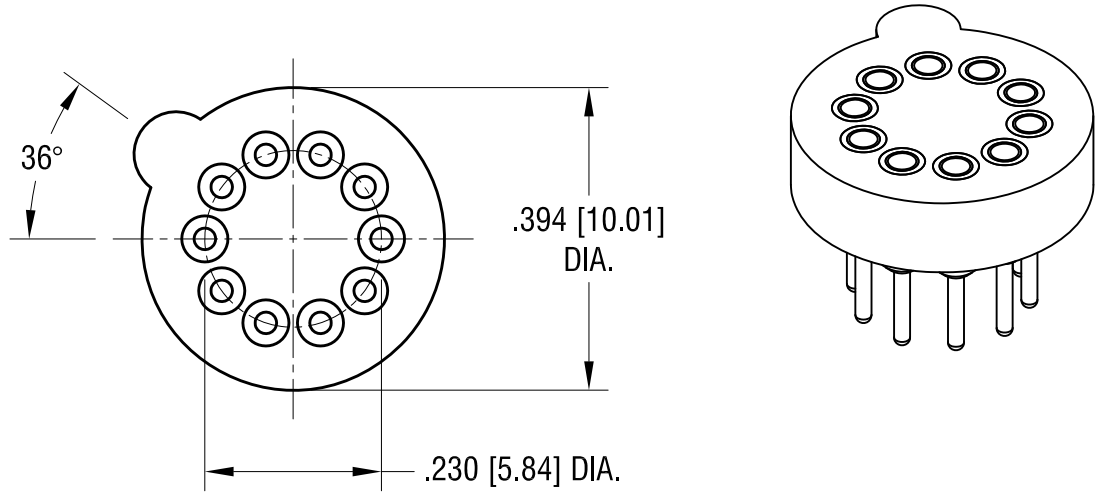

NOTES:

- 1. INSULATOR:
MAT'L - GLASS FILLED POLYESTER
- CONTACT PIN:
MAT'L - BRASS
FINISH - TIN PLATE
- CONTACT SPRING:
MAT'L - BERYLLIUM COPPER
FINISH - .0000300 [.00076] GOLD PLATE

KEYSTONE ELECTRONICS CORP.			
www.keyelco.com • ASTORIA, N.Y. 11105-2017 • Tel (718) 956-8900			
PART NAME			
TRANSISTOR SOCKET FOR TO-100			
MATERIAL			
AS NOTED			
FINISH		DRN BY	DATE
AS NOTED		BOONE	7.09.10
		APP'D	SCALE
		LN	4X
TOLERANCES	INCH [MM]	CODE	DWG NO.
DECIMAL	± .005 [± 0.15]	C/M	4594
ANGULAR	± 1°		
UNLESS OTHERWISE SPECIFIED			

DATE	DESCRIPTION	REV.	
------	-------------	------	--