



SERIES: VX78-500 | **DESCRIPTION:** NON-ISOLATED DC SWITCHING REGULATOR

FEATURES

- wide input
- pin-out compatible with linear regulators
- encapsulated
- UL & CSA approved
- high efficiency up to 95%
- no-load input current as low as 0.2 mA
- wide operating temp: -40°C to +85°C
- supports negative output
- short circuit protection on the output



MODEL	input voltage ¹		output voltage (Vdc)	output current max (mA)	output power max (W)	ripple & noise ² max (mVp-p)	efficiency ³ typ (%)
	typ (Vdc)	range (Vdc)					
VX7803-500	24	4.75~36	3.3	500	1.65	75	86
VX7805-500	24	6.5~36	5	500	2.5	75	90
	12	7~31	-5	-300	1.5	75	80
VX78039-500	24	12~36	9	500	4.5	75	93
VX78012-500	24	15~36	12	500	6	75	94
	12	8~24	-12	-150	1.8	75	84
VX7815-500	24	19~36	15	500	7.5	75	95
	12	8~21	-15	-150	2.25	75	85

Notes: 1. For input voltages higher than 30 Vdc, a 22 µF / 50 V input capacitor is required.
 2. Tested at nominal input, 10~100% load, 20 MHz bandwidth, with 10 µF electrolytic and 1 µF ceramic capacitor on the output. At loads below 10%, the max ripple and noise of the 3.3 & 5 Vdc outputs will be 150 mVp-p, and the other outputs will be 2% Vo.
 3. Measured at min Vin, full load.
 4. All specifications are measured at Ta=25°C, humidity < 75%, nominal input voltage, and rated output load unless otherwise specified.

PART NUMBER KEY



INPUT

parameter	conditions/description	min	typ	max	units
operating input voltage ¹	for positive output applications	4.75	24	36	Vdc
	for negative output applications	7	12	31	Vdc
filter	capacitor filter				
input reverse polarity protection	no				
no-load input current	positive outputs		0.2	1.5	mA

Note: 1. See Model section on page 1 for specific input voltage ranges.

OUTPUT

parameter	conditions/description	min	typ	max	units
maximum capacitive load ²	for positive output applications			680	μF
	for negative output applications			330	μF
voltage accuracy	at full load, input voltage range 3.3 Vdc output model		±2	±4	%
	all other models		±2	±3	%
line regulation	at full load, input voltage range		±0.2	±0.4	%
load regulation	at nominal input, 10~100% load		±0.4	±0.6	%
switching frequency	at nominal input voltage, full load	550		850	kHz
transient recovery time	at nominal input voltage, 25% load step change		0.2	1	ms
transient response deviation	at nominal input voltage, 25% load step change		50	250	mV
temperature coefficient	at full load			±0.03	%/°C

Note: 2. The maximum capacitive load was tested at nominal input voltage, full load.

PROTECTIONS

parameter	conditions/description	min	typ	max	units
short circuit protection	continuous, auto recovery				

SAFETY AND COMPLIANCE

parameter	conditions/description	min	typ	max	units
safety approvals	UL 60950-1				
EMI/EMC	EN 55032, EN 55024				
conducted emissions	CISPR22/EN55022, class B (external circuit required, see Figure 6-b)				
radiated emissions	CISPR22/EN55022, class B (external circuit required, see Figure 6-b)				
ESD	IEC/EN61000-4-2, contact ± 4kV, class B				
radiated immunity	IEC/EN61000-4-3, 10V/m, class A				
EFT/burst	IEC/EN61000-4-4, ± 1kV, class B (external circuit required, see Figure 6-a)				
surge	IEC/EN61000-4-5, line-line ± 1kV, class B (external circuit required, see Figure 6-a)				
conducted immunity	IEC/EN61000-4-6, 3 Vr.m.s, class A				
MTBF	as per MIL-HDBK-217F, 25°C	2,000,000			hours
RoHS	2011/65/EU				

ENVIRONMENTAL

parameter	conditions/description	min	typ	max	units
operating temperature	see derating curve	-40		85	°C
storage temperature		-55		125	°C
storage humidity	non-condensing	5		95	%

SOLDERABILITY

parameter	conditions/description	min	typ	max	units
wave soldering	see wave soldering profile			260	°C



MECHANICAL

parameter	conditions/description	min	typ	max	units
dimensions	11.60 x 7.55 x 10.16 [0.457 x 0.297 x 0.400 inch]				mm
case material	black flame-retardant heat-proof plastic (UL94V-0)				
weight			1.8		g

MECHANICAL DRAWING

units: mm [inch]
 tolerance: ±0.25[±0.010]
 pin diameter tolerance: ±0.10[±0.004]

PIN CONNECTIONS		
PIN	+OUTPUT	-OUTPUT
1	+VIN	+VIN
2	GND	-VOUT
3	+VOUT	GND

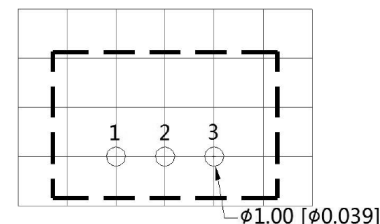
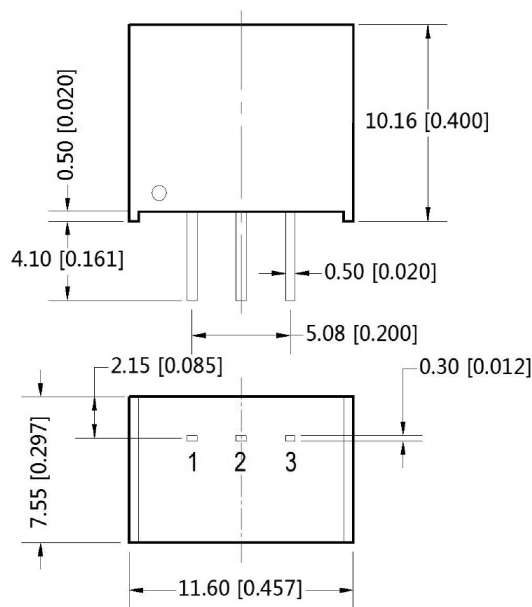

Note : Grid 2.54*2.54mm
 Recommended PCB Layout
 Top View

DERATING CURVE



EFFICIENCY CURVES

VX7803-500 Efficiency Curve
Positive Output, Efficiency vs. Input Voltage
(at full load)



VX7803-500 Efficiency Curve
Positive Output, Efficiency vs. Load Current
(at Vin nominal)

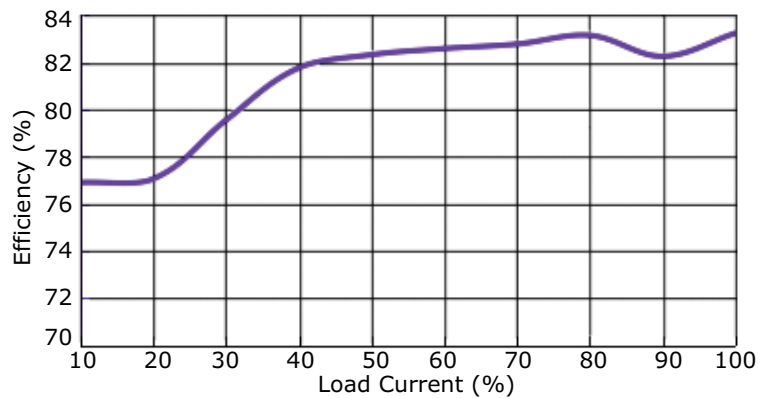

VX78012-500 Efficiency Curve
Positive Output, Efficiency vs. Input Voltage
(at full load)

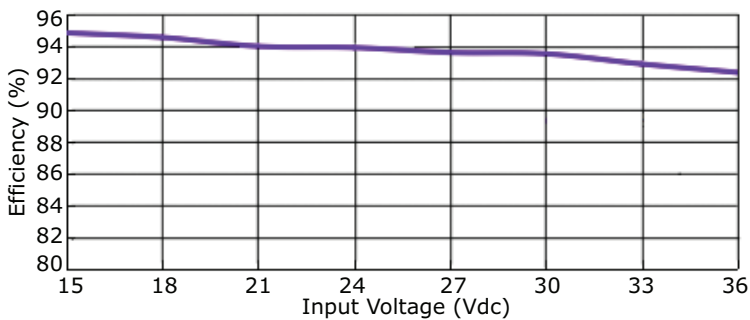

VX78012-500 Efficiency Curve
Positive Output, Efficiency vs. Load Current
(at Vin nominal)

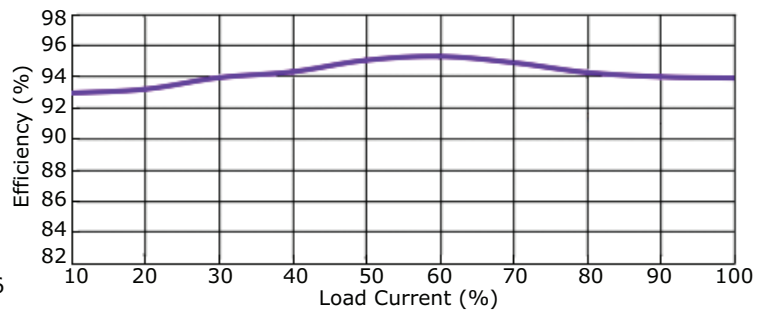

EFFICIENCY CURVES (CONTINUED)

VX78012-500 Efficiency Curve
Negative Output, Efficiency vs. Input Voltage
(at full load)

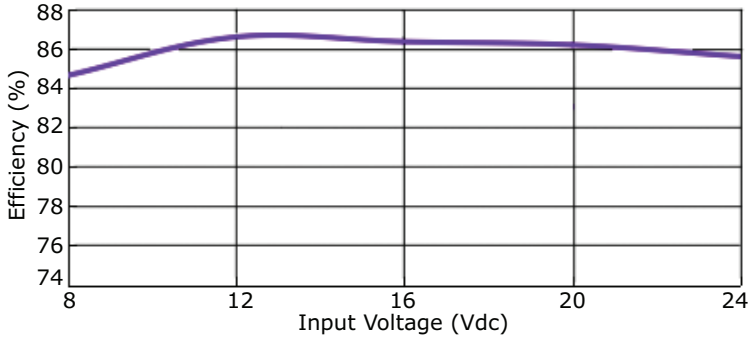

VX78012-500 Efficiency Curve
Negative Output, Efficiency vs. Load Current
(at Vin nominal)

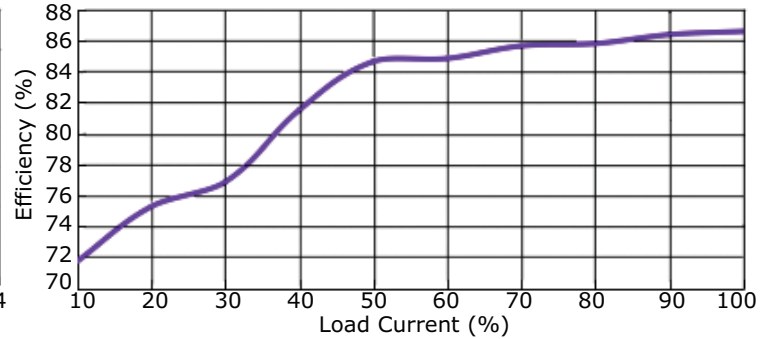

VX7815-500 Efficiency Curve
Positive Output, Efficiency vs. Input Voltage
(at full load)

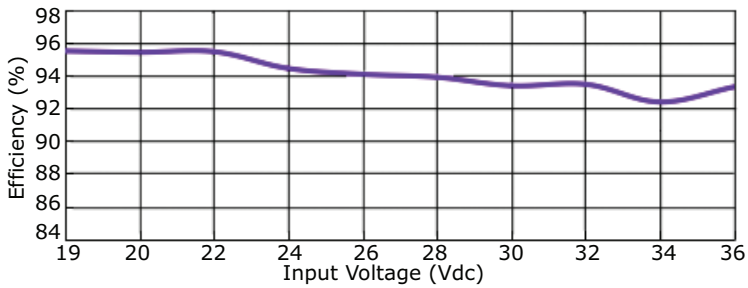

VX7815-500 Efficiency Curve
Positive Output, Efficiency vs. Load Current
(at Vin nominal)

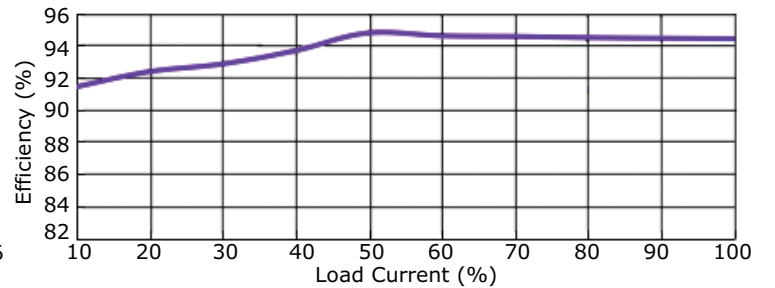

VX7815-500 Efficiency Curve
Negative Output, Efficiency vs. Input Voltage
(at full load)

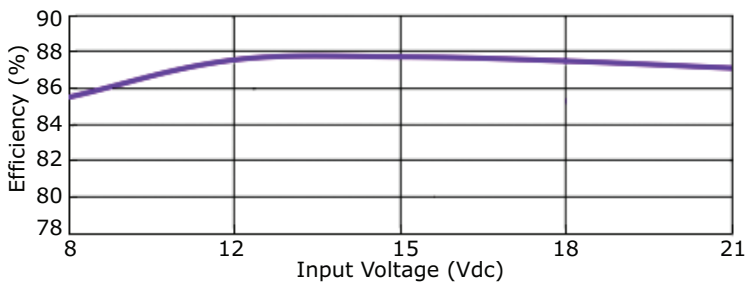

VX7815-500 Efficiency Curve
Negative Output, Efficiency vs. Load Current
(at Vin nominal)

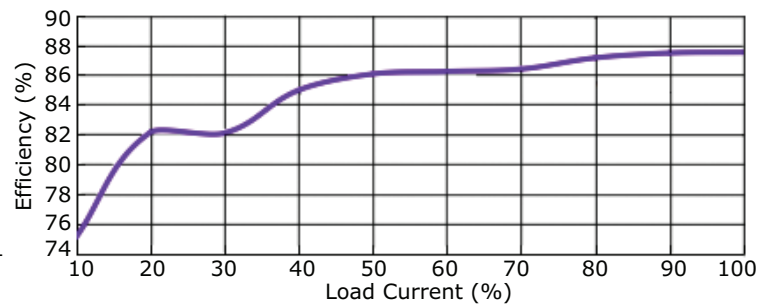

TYPICAL APPLICATION CIRCUIT

Figure 1

Positive Output Application Circuit



Figure 2

Negative Output Application Circuit

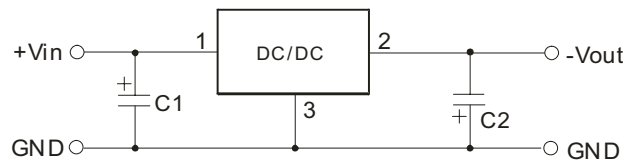

Figure 3

Positive and Negative Output Paralleling Application Circuit

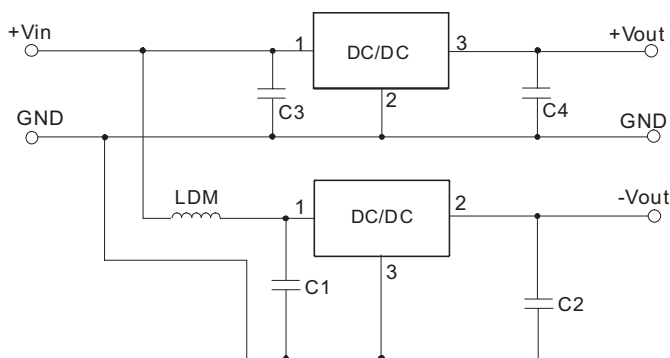

Table 1

External Capacitor Table

Model Number	C1, C3 (ceramic capacitor)	C2, C4 (ceramic capacitor)
VX7803-500	10 μ F/50 V	22 μ F/10 V
VX7805-500	10 μ F/50 V	22 μ F/10 V
VX78039-500	10 μ F/50 V	22 μ F/16 V
VX78012-500	10 μ F/50 V	22 μ F/25 V
VX7815-500	10 μ F/50 V	22 μ F/25 V

Figure 4

Positive Output Ripple Reduction Circuit



Figure 5

Negative Output Ripple Reduction Circuit



EMC RECOMMENDED CIRCUIT

Figure 6

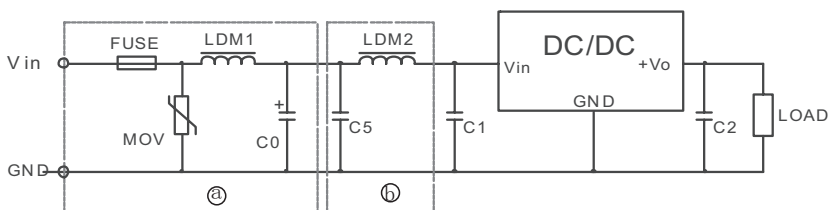

Table 2

Recommended external circuit components	
FUSE	choose according to actual input current
MOV	S20K30
LDM1	82 μ H
C0	680 μ F/50 V
C1, C2	see Table 1
C5	4.7 μ F/50 V
LDM2	12 μ H

- Note:
1. C1 & C2 (C3 & C4) are required and should be connected as close to the module pins as possible.
 2. To reduce the output ripple further, it is recommended to connect an "LC" filter at the output terminal with a recommended value of 10~47 μ H for the L component. (See Figures 4 & 5).
 3. When using application circuit in Figure 3, a 10 μ H LDM component is recommended to reduce the interference.

PACKAGING

units: mm

Tube Size: 9.6 x 16.9 x 530 mm

QTY: 43 pcs

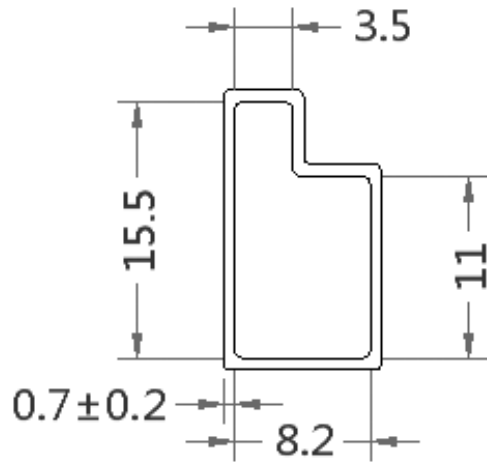

REVISION HISTORY

rev.	description	date
1.0	initial release	05/18/2017

The revision history provided is for informational purposes only and is believed to be accurate.

**CUI INC**[®]**Headquarters**
20050 SW 112th Ave.
Tualatin, OR 97062
800.275.4899Fax 503.612.2383
cui.com
techsupport@cui.com

CUI offers a two (2) year limited warranty. Complete warranty information is listed on our website.

CUI reserves the right to make changes to the product at any time without notice. Information provided by CUI is believed to be accurate and reliable. However, no responsibility is assumed by CUI for its use, nor for any infringements of patents or other rights of third parties which may result from its use.

CUI products are not authorized or warranted for use as critical components in equipment that requires an extremely high level of reliability. A critical component is any component of a life support device or system whose failure to perform can be reasonably expected to cause the failure of the life support device or system, or to affect its safety or effectiveness.