



MAX11666 Evaluation Kit

General Description

The MAX11666 evaluation kit (EV kit) is a fully assembled and tested PCB that evaluates the MAX11666 2-channel, 12-bit, SPI™-compatible 500ksps analog-to-digital converter (ADC). The EV kit also includes Windows XP®, Windows Vista®, and Windows® 7-compatible software that provides a simple graphical user interface (GUI) for exercising the features of the device. The EV kit comes installed with a MAX11666AUB+ in a 10-pin μ MAX® package with an exposed pad.

Features

- ◆ 8MHz SPI Interface
- ◆ Windows XP-, Windows Vista-, and Windows 7-Compatible Software
- ◆ Time Domain, Frequency Domain, and Histogram Plotting in the EV Kit Software
- ◆ Frequency, RMS, Min, Max, and Average DC Calculations in the EV Kit Software
- ◆ Collects Up to One Million Samples
- ◆ On-Board Input Buffers
- ◆ USB-PC Connection
- ◆ Proven PCB Layout
- ◆ Fully Assembled and Tested

Ordering Information

PART	TYPE
MAX11666EVKIT#	EV Kit

#Denotes RoHS compliant.

Component List

DESIGNATION	QTY	DESCRIPTION
AIN1_AC, AIN1_DC, AIN2_AC, AIN2_DC, CHSEL, CS, DOUT, REF, SCLK	9	White test points
AIN1_AC_SMA, AIN1_DC_SMA, AIN2_AC_SMA, AIN2_DC_SMA, 10MHZCLK	5	50 Ω SMA female jacks
AVDD, OP+, OVDD, VIN	4	Red test points
BUTTON, CPU_RESET, RECONFIGURE	3	Pushbutton switches

DESIGNATION	QTY	DESCRIPTION
C1, C3	2	1000pF \pm 10%, 50V X7R ceramic capacitors (0603) Murata GRM188R71H102K
C2, C4, C31, C34, C36, C42, C43, C47, C51, C55–C72, C78, C79, C80, C82, C84, C86, C88, C89, C90, C92, C98, C99	39	0.1 μ F \pm 10%, 25V X7R ceramic capacitors (0603) Murata GRM188R71E104K
C5–C29	25	0.1 μ F \pm 10%, 16V X7R ceramic capacitors (0402) Murata GRM155R71C104K
C30, C35, C91, C94, C95, C96, CB1, CB2, CB3	9	1 μ F \pm 10%, 16V X7R ceramic capacitors (0603) Murata GRM188R71C105K
C32	1	0.01 μ F \pm 10%, 16V X7R ceramic capacitor (0603) Murata GRM188R71C103K

SPI is a trademark of Motorola, Inc.

Windows, Windows XP, and Windows Vista are registered trademarks of Microsoft Corp.

μ MAX is a registered trademark of Maxim Integrated Products, Inc.



MAX11666 Evaluation Kit

Evaluates: MAX11666

Component List (continued)

DESIGNATION	QTY	DESCRIPTION
C33, C38, C39, C40, C97	5	4.7 μ F \pm 10%, 6.3V X5R ceramic capacitors (0603) Murata GRM188R60J475K
C37, C41, C44, C45, C46, C48, C50, C52, C73, C87, C93, CP2, CP3	13	10 μ F \pm 10%, 6.3V X5R ceramic capacitors (0603) Murata GRM188R60J106M
C49, C53, C74, C100, C102, C105, C106	0	Not installed, ceramic capacitors (0603)
C54, C101	0	Not installed, ceramic capacitors (through hole)
C75, C76	2	18pF \pm 5%, 50V C0G ceramic capacitors (0603) Murata GRM1885C1H180J
C77, C81	2	10 μ F \pm 20%, 10V capacitors (Tant B) KEMET T491B106M010AT
C83, C85	2	4.7 μ F \pm 20%, 25V capacitors (Tant B) AVX TAJB475M025R
C103	1	10 μ F \pm 10%, 10V X7R ceramic capacitor (0805) Murata GRM21BR71A106K
C104	0	Not installed, ceramic capacitor (0805)
CC1–CC4	4	10pF \pm 5%, 50V C0G ceramic capacitors (0603) Murata GRM1885C1H100J
CP1	1	100 μ F \pm 20%, 6.3V X5R ceramic capacitor (1210) Murata GRM32ER60J107M
GND	9	Black test points
J1	0	Not installed, dual-row, 32-pin (2 x 16) header
J2	1	USB type-B right-angle PC-mount receptacle
JTAG1, JTAG2	0	Not installed, dual-row, 10-pin (2 x 5) headers

DESIGNATION	QTY	DESCRIPTION
JU1–JU4, JU10–JU16, JU18, JU21	13	3-pin headers
JU5–JU8, JU17, JU19, JU20, JU22, JU23	9	2-pin headers
JUC1–JUC7	0	Not installed, 3-pin headers—short (PC trace)
L1	1	Ferrite bead (0603) TDK MMZ1608R301A
L3	0	Not installed, inductor—short (PC trace)
LED1–LED4	4	Red LEDs (0603)
OP-	1	Brown test point
R1, R2, R5, R6, R7	5	100k Ω \pm 5% resistors (0603)
R3, R4, R38, R39, R40, R44, R45, R47	8	1k Ω \pm 5% resistors (through hole)
R10, R33	2	22 Ω \pm 5% resistors (0603)
R11–R21	11	5.1k Ω \pm 5% resistors (0603)
R22–R25, R28, R34, R35, R41	8	10k Ω \pm 1% resistors (0603)
R26	1	16.5k Ω \pm 1% resistor (0603)
R27	1	4.42k Ω \pm 1% resistor (0603)
R29	1	20k Ω \pm 1% resistor (0603)
R30, RC1–RC7	8	10k Ω \pm 5% resistors (0603)
R31, R37, R46	0	Not installed, resistors (0603)
R32	1	12.1k Ω \pm 1% resistor (0603)
R36	1	0 Ω \pm 5% resistor (0603)
R42, R43	2	10 Ω \pm 1% resistors (0603)
RC8, RC9, RC10	3	1k Ω \pm 5% resistors (0603)
RL1–RL4	4	120 Ω \pm 5% resistors (0603)
RN14–RN21	8	22 Ω , 8-pin SMT resistor networks
RN22	1	5.1k Ω , 8-pin SMT resistor network
RN25	1	10k Ω , 8-pin SMT resistor network
RSENSE1, RSENSE2	2	0.1 Ω \pm 1%, 1/2W sensing resistors (1206)

MAX11666 Evaluation Kit

Evaluates: MAX11666

Component List (continued)

DESIGNATION	QTY	DESCRIPTION
S1	1	4-position SMT half-pitch DIP switch
U1	1	12-bit, 500ksps ADC (10 μ MAX-EP) Maxim MAX11666AUB+
U2	1	Cyclone III FPGA Altera EP3C25F324C8N
U5	1	256K x 36 SSRAM (100 TQFP) ISSI IS61LPS25636A-200TQLI
U6	0	Not installed, 32M x 16 flash (64 EBGA) Numonyx/Intel PC28F256P30BFA
U7	1	EPCS16 (8 SO) Altera EPCS16SI8N
U8, U20	2	Current-sense amplifiers (8 μ MAX) Maxim MAX9929FAUA+
U9, U16	2	Op amps (5 SOT23) Maxim MAX4430EUK+

DESIGNATION	QTY	DESCRIPTION
U10, U11, U12	3	LDOs (16 TSSOP-EP) Maxim MAX1793EUE50+
U13	1	LDO (6 SOT23) Maxim MAX1983EUT+
U14	1	SRAM (48 TSOP) Cypress CY62167DV30LL-55ZXI
U15	1	USB PHY (SOT617-1) ST Ericsson ISP1504ABS
U17	1	3V voltage reference (8 SO) Maxim MAX6126AASA30+
U18, U19	2	Dual buffers (6 SC70)
Y1	1	50MHz oscillator
Y2	1	19.2MHz, 18pF SMD crystal
—	1	USB high-speed A-to-B cables, 6ft
—	22	Shunts
—	1	PCB: MAX11666 EVALUATION KIT

Component Suppliers

SUPPLIER	PHONE	WEBSITE
Altera Corp.	800-800-3753	www.altera.com
AVX Corporation	843-946-0238	www.avxcorp.com
KEMET Corp.	864-963-6300	www.kemet.com
Murata Electronics North America, Inc.	770-436-1300	www.murata-northamerica.com
TDK Corp.	847-803-6100	www.component.tdk.com

Note: Indicate that you are using the MAX11666 when contacting these component suppliers.

MAX11666 EV Kit Files

FILE	DESCRIPTION
INSTALL.EXE	Installs the EV system files on your computer
MAX11666.EXE	Application program
SLSUSB.DLL	Software library file
SLSUSB.INF	USB device driver file
SLSUSB.SYS	USB device driver file
SLS_USB_Driver_Help_100.PDF	USB driver installation file

MAX11666 Evaluation Kit

Quick Start

Required Equipment

- MAX11666 EV kit
- 5V, 500mA DC power supply
- Windows XP, Windows Vista, or Windows 7 PC with a spare USB port
- Function generator

Note: In the following sections, software-related items are identified by bolding. Text in **bold** refers to items directly from the EV kit software. Text in **bold and underlined** refers to items from the Windows operating system.

Procedure

The EV kit is fully assembled and tested. Follow the steps below to verify board operation. **Caution: Do not turn on the power supply until all connections are completed.**

- 1) Uncompress the 11666Rxx.ZIP file in a temporary folder.
- 2) Install the EV kit software on your computer by running the INSTALL.EXE program inside the temporary folder. The program files are copied to your PC and icons are created in the Windows **All Programs** menu. During software installation, some versions of Windows may show a warning message indicating that this software is from an unknown publisher. This is not an error condition and it is safe to proceed with installation. Administrator privileges are required to install the software on Windows.
- 3) Verify that all jumpers are in their default positions, as shown in Table 1.
- 4) Connect the positive terminal of the 5V power supply to the VIN connector on the board. Connect the negative terminal of the same power supply to the GND connector on the board.
- 5) Set the signal source to generate a 10kHz, 1V peak-to-peak sinusoidal wave with 2V offset.
- 6) Connect the positive terminal of the signal generator to the AIN1_DC or AIN1_DC_SMA connector. Connect the negative terminal of the signal generator to the GND connector.
- 7) Turn on the power supply.
- 8) Turn on the function generator.
- 9) Connect the USB cable from the PC to the EV kit board. Follow the instructions on the SLS_USB_Driver_Help_100.PDF file to manually install the USB driver. Administrator privileges are required to install the USB device driver on Windows.
- 10) Start the EV kit software by opening its icon in the Windows **All Programs** menu. The EV kit software main window appears, as shown in Figure 1.
- 11) The main window should display **Hardware Connected** at the bottom-left corner
- 12) Check the **Remove DC** checkbox.
- 13) Press the **Start Conversion** button.
- 14) Verify that the **Frequency** displayed in the **Calculation** group box reads approximately 10kHz.

Detailed Description of Software

The main window of the evaluation software (Figure 1) contains a **Device Configuration** group box, a **Datalogging** group box, and four tab sheets to display the sampled data.

Device Configuration

Use the **Channel Select** drop-down list in the **Device Configuration** group box to select the analog input channel for analog-to-digital conversion.

Data Logging

In the **Datalogging** group box, the user can select the desired number of conversions in the **Number of Samples** drop-down list. Enter the desired sampling rate in the **Sample Rate (ksps)** edit box. The actual sampling rate is displayed at the right of the **Sample Rate (ksps)** edit box. Press the **Start Conversion** button to start sampling. After sampling is finished, the user can save the data to a file by pressing the **Save to File** button. The **Save to File** button is not active until the sampling is done.

Time Domain, Frequency Domain, Histogram, and Single Conversion Tabs

After the **Start Conversion** button in the **Datalogging** group box is pressed, the sampled data in the time domain is plotted in the **Time Domain** tab sheet. The sampled data in the frequency domain is plotted in the **Frequency Domain** tab sheet, and the histogram of the sampled signal is plotted in the **Histogram** tab sheet.

MAX11666 Evaluation Kit

Evaluates: MAX11666

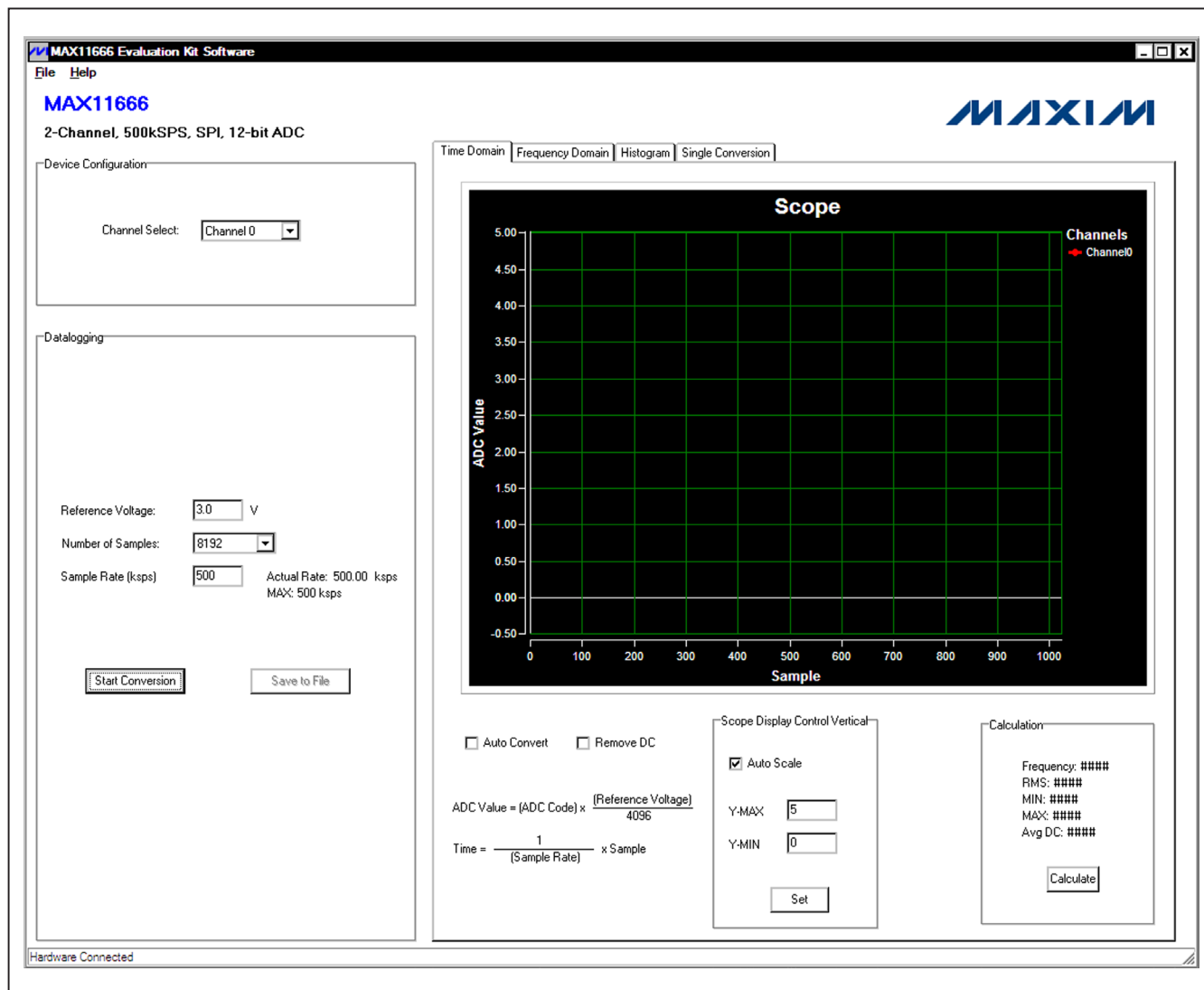

Figure 1. MAX11666 EV Kit Software Main Window

The **Single Conversion** tab sheet displays one sampled data.

Check the **Auto Convert** checkbox to automatically and repeatedly do the ADC conversions and update the active tab sheet.

Time Domain Tab

In the **Time Domain** tab sheet (Figures 2a and 2b), check the **Remove DC** check box to remove the DC component of the sampled signal. In the **Scope Display Control Vertical** group box, when the **Auto Scale** checkbox is checked, the software automatically scales

the vertical axis in the plot. If the **Auto Scale** checkbox is unchecked, enter the appropriate values into the **Y-MAX** and **Y-MIN** edit boxes and press the **Set** button to set the boundaries for the vertical axis. The software automatically calculates the **Frequency**, **RMS**, **MIN**, **MAX**, and **Avg DC** of the sampled signal and displays the calculated values in the **Calculation** group box.

Frequency Domain Tab

The **Frequency Domain** tab sheet (Figure 3) displays the FFT plot of the signal shown in the **Time Domain** tab sheet.

MAX11666 Evaluation Kit

Evaluates: MAX11666

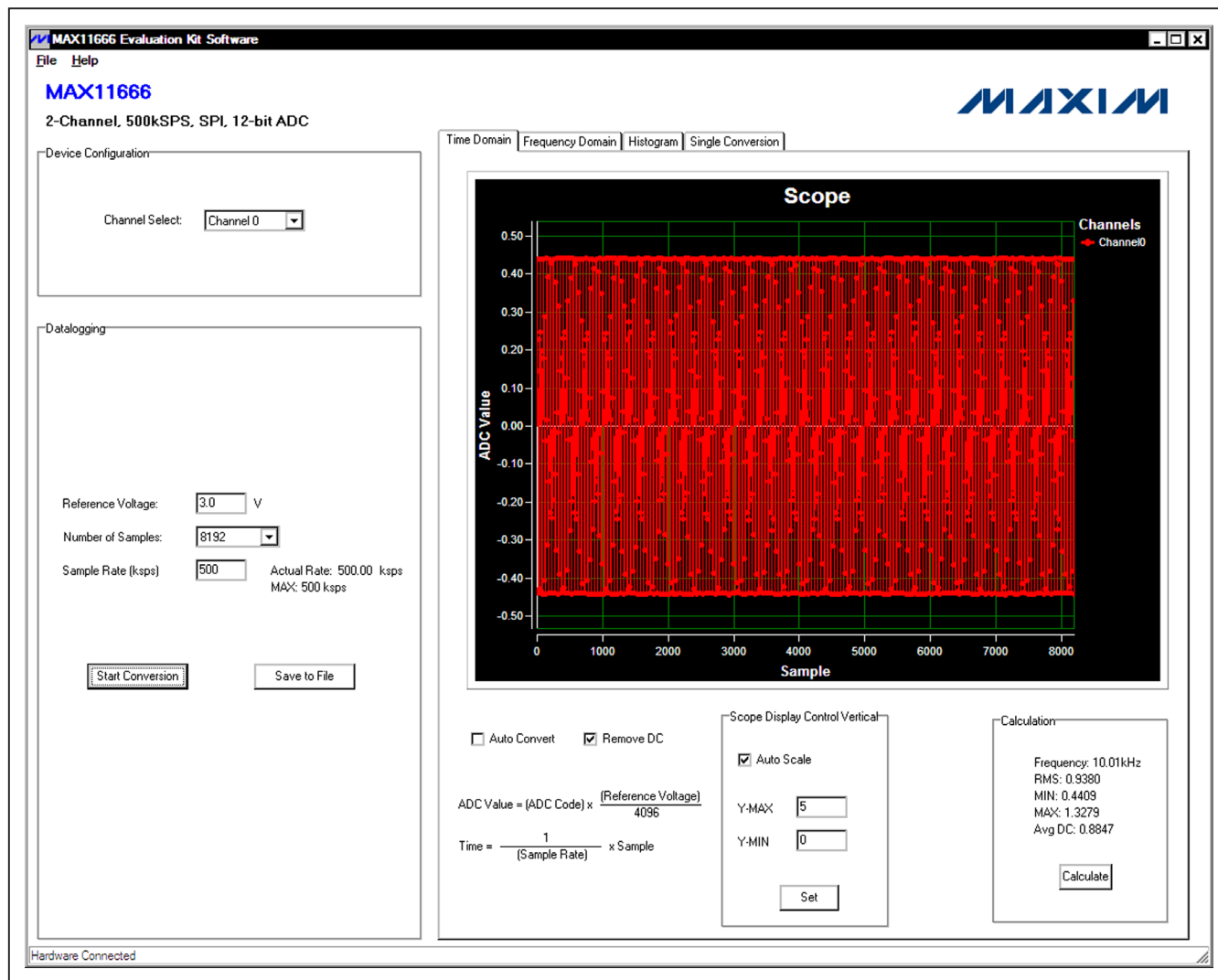

Figure 2a. Time Domain Tab

MAX11666 Evaluation Kit

Evaluates: MAX11666

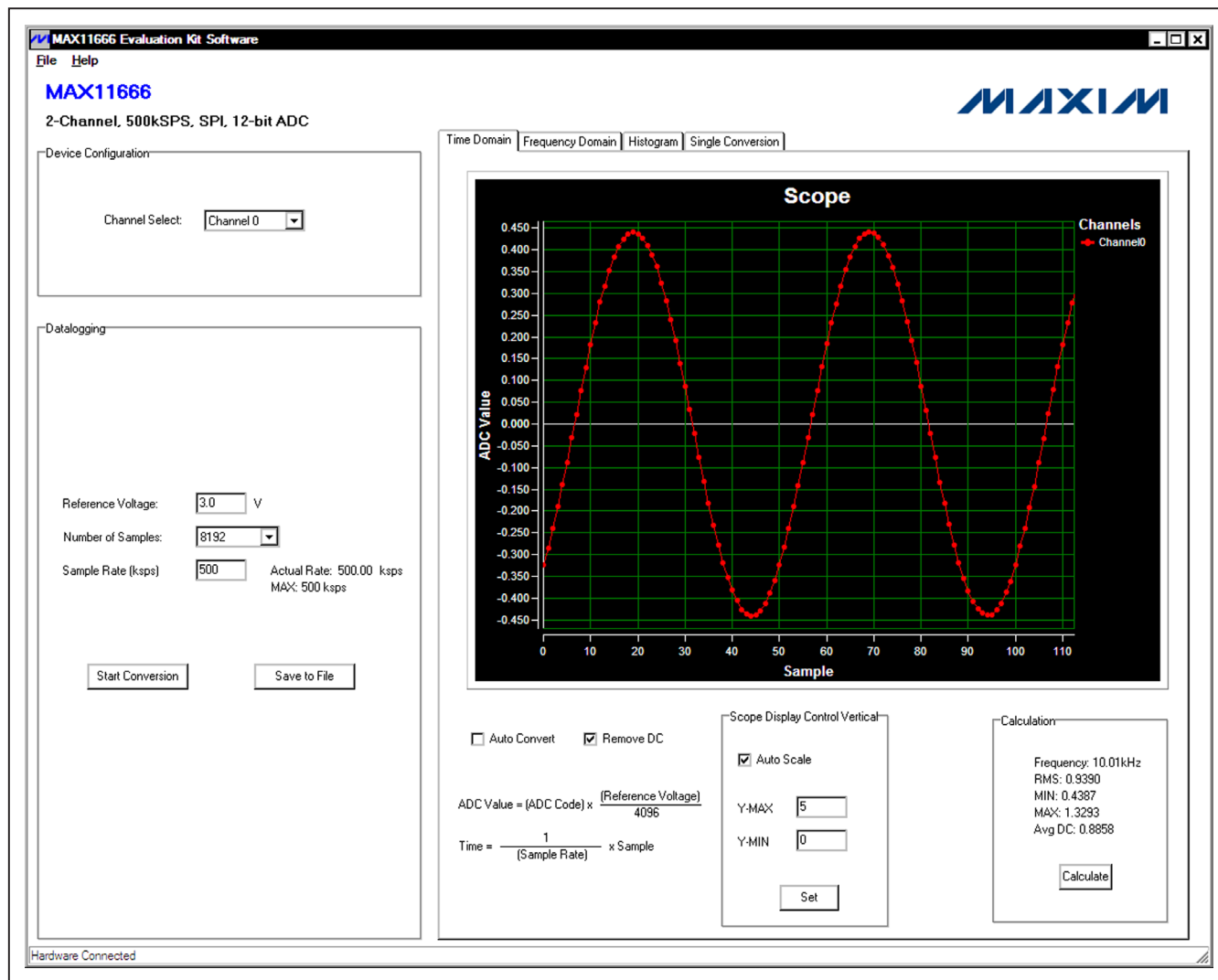

Figure 2b. Time Domain Tab (Zoomed In)

MAX11666 Evaluation Kit

Histogram Tab

The **Histogram** tab sheet (Figure 4) displays the histogram of the signal shown in the **Time Domain** tab sheet. The software automatically calculates the **Mean** and the **Std Dev** (standard deviation, sigma) and displays the calculated values in the **Calculation** group box.

The **Histogram Display Control** radio group box provides three options to scale the horizontal axis on the histogram:

- 1) **(Mean - 3 sigma) to (Mean + 3 sigma)**
- 2) **(Mean - 6 sigma) to (Mean + 6 sigma)**
- 3) **User Define** range

Single Conversion

The **ADC Value Display** group box in the **Single Conversion** tab sheet (Figure 5) displays the **ADC Code** and calculated **Voltage** values for a single sample. Press the **Start Conversion** button in the **Datalogging** group box to update the status of the **ADC Value Display** group box.

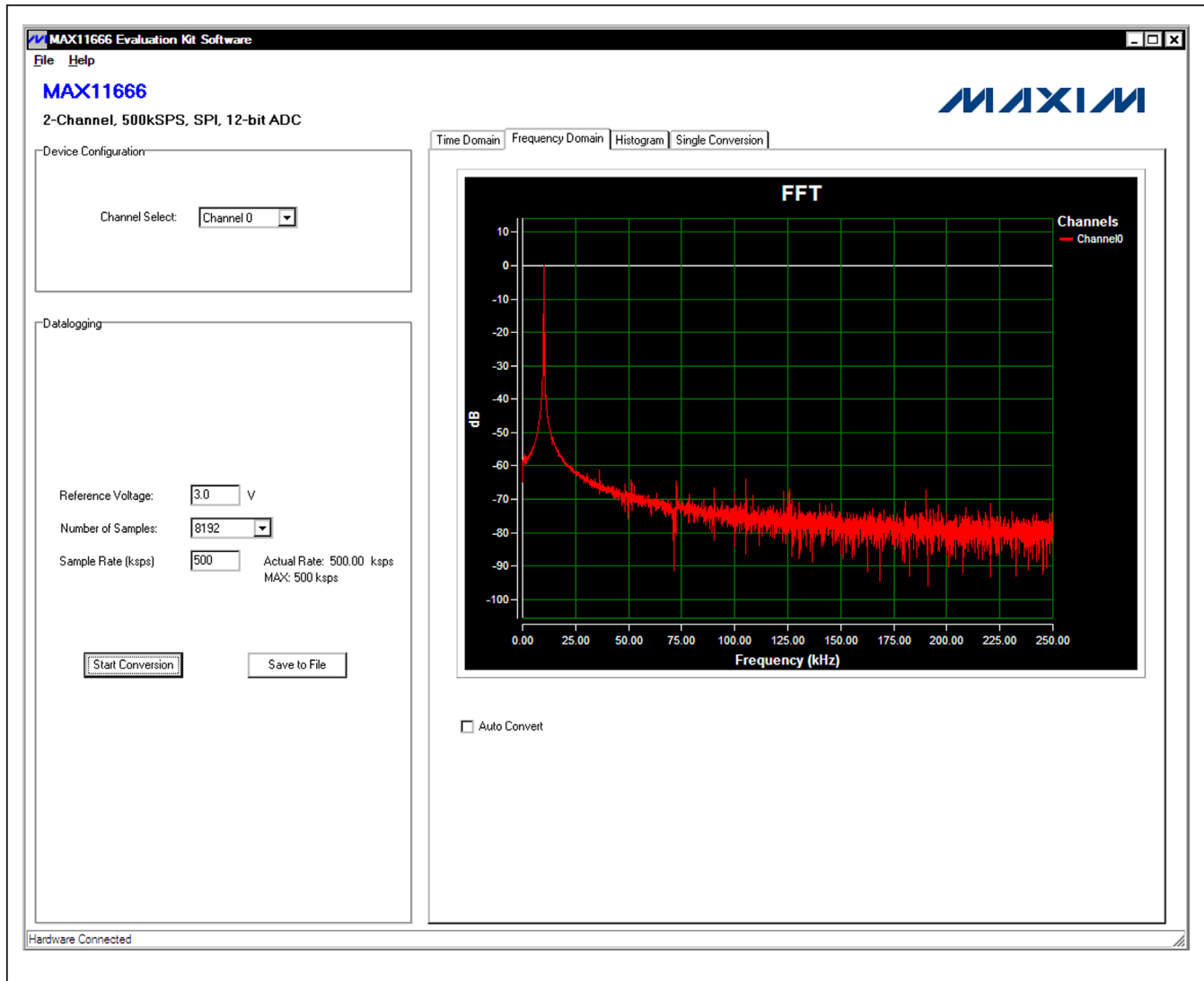

Figure 3. Frequency Domain Tab

MAX11666 Evaluation Kit

Evaluates: MAX11666

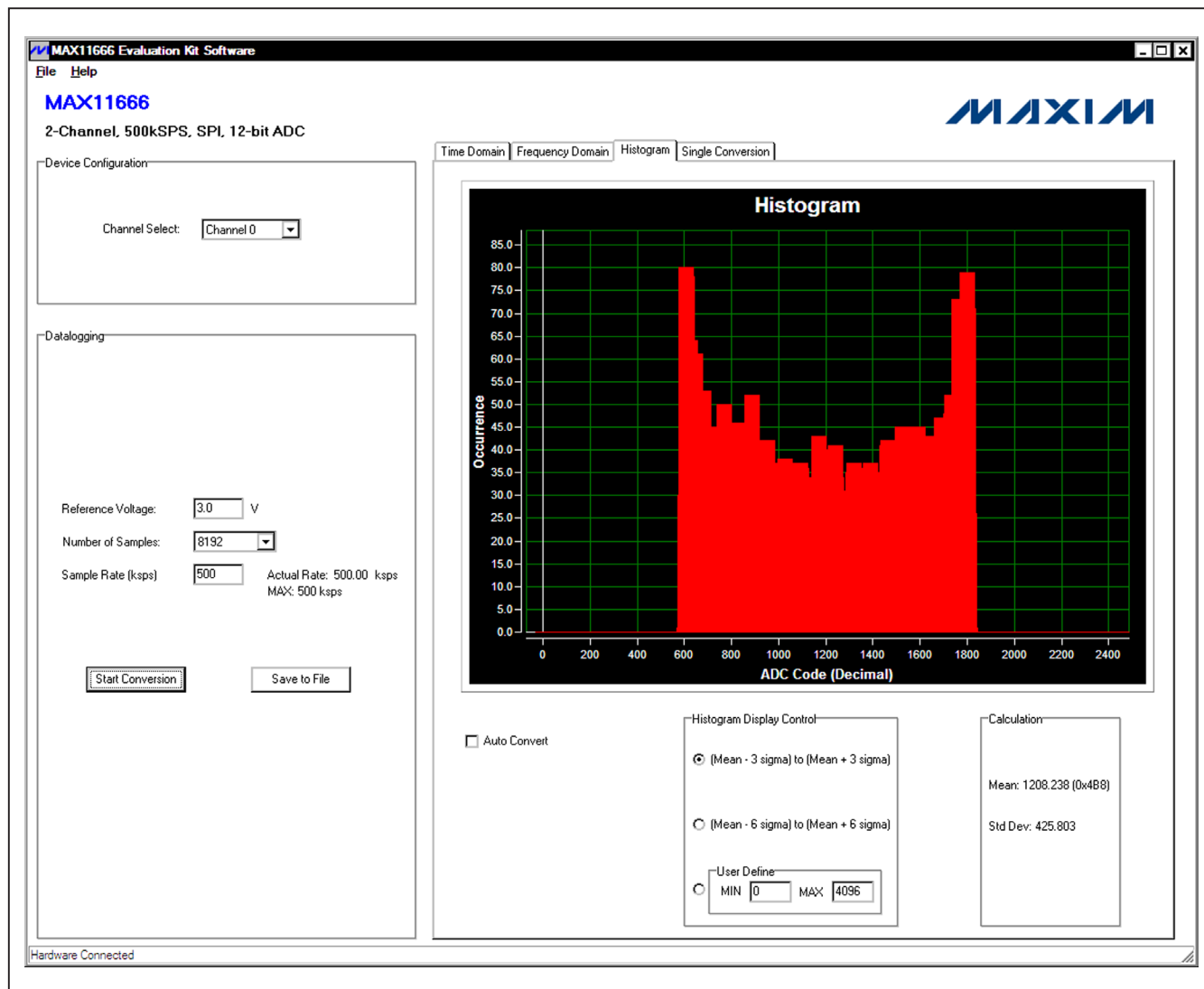

Figure 4. Histogram Tab

MAX11666 Evaluation Kit

Evaluates: MAX11666

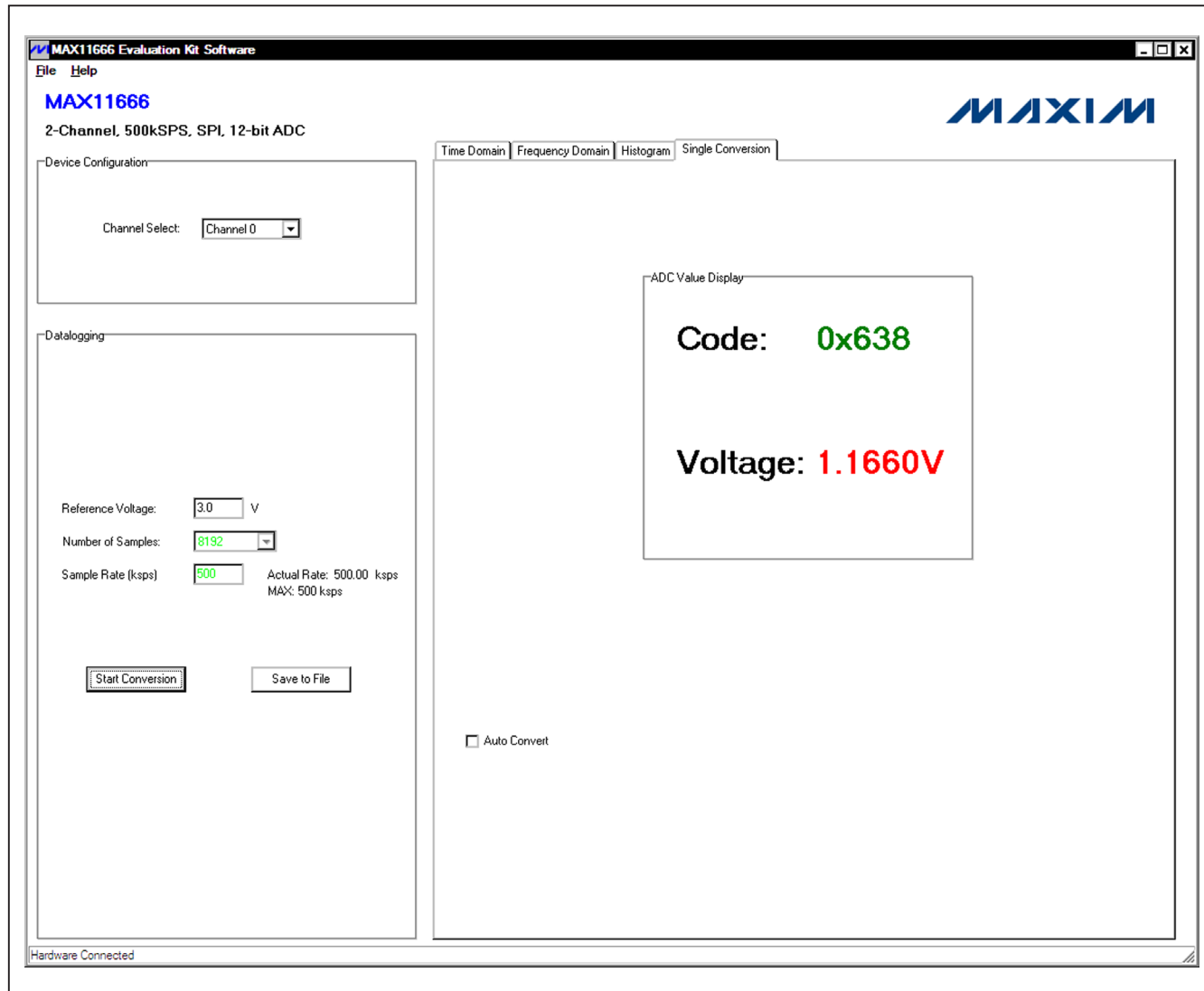

Figure 5. Single Conversion Tab

MAX11666 Evaluation Kit

Evaluates: MAX11666

Detailed Description of Hardware

The MAX11666 EV kit is a fully assembled and tested PCB that evaluates the MAX11666 2-channel, 12-bit, SPI-compatible 500ksps ADC. The EV kit comes installed with a MAX11666AUB+ in a 10-pin μ MAX package with an exposed pad.

Power Supply

A 5V power supply is required to power up the EV kit. Connect the positive terminal of the power supply to the VIN connector and the negative terminal to the GND connector.

On-Board Input Buffer

On-board input buffers (U9 and U16) are provided on the EV kit. To power the on-board buffer, connect the +5V, GND, and -5V terminals of the power supply to the OP+, GND, and OP- connectors, respectively.

Analog Input 1

Move the shunt on jumper JU18 to the 2-3 position and remove the shunts on jumpers JU19 and JU20. The user can connect the AC signal to the AIN1_AC_SMA or AIN1_AC connector and connect the DC offset to the AIN1_DC_SMA or AIN1_DC connector. If the measuring signal has already been shifted above the ground level, short the AC input to ground by installing a shunt on JU19 and connecting the measuring signal to the

AIN1_DC_SMA or AIN1_DC connector. To bypass the buffer and connect the measuring signal directly to the AIN1 input of the ADC, move the shunt on JU18 to the 1-2 position. Then connect the measuring signal to the AIN1_DC_SMA or AIN1_DC connector.

Analog Input 2

Move the shunt on jumper JU21 to the 2-3 position and remove the shunts on jumpers JU22 and JU23. The user can connect the AC signal to the AIN2_AC_SMA or AIN2_AC connector and connect the DC offset to the AIN2_DC_SMA or AIN2_DC connector. If the measuring signal has already been shifted above the ground level, short the AC input to ground by installing a shunt on JU23 and connect the measuring signal to the AIN2_DC_SMA or AIN2_DC connector. To bypass the buffer and connect the measuring signal directly to the AIN2 input of the ADC, move the shunt on JU21 to the 1-2 position. Finally, connect the measuring signal to the AIN2_DC_SMA or AIN2_DC connector.

User-Supplied SPI Interface

For a user-supplied SPI interface, first move the shunts on jumpers JU12–JU15 to the 2-3 position and connect the user-supplied \overline{CS} , SCLK, CHSEL, and MISO signals to the corresponding \overline{CS} , SCLK, CHSEL, and DOUT connectors on the EV kit.

Table 1. Jumper Settings (JU1–JU8, JU10–JU23)

JUMPER	SHUNT POSITION	DESCRIPTION
JU1	1-2	Connects the USB power to the input of the on-board LDO (U10).
	2-3*	Connects the external power supply to the input of the on-board LDO (U10).
JU2	1-2	Connects the USB power to the input of the on-board LDO (U11).
	2-3*	Connects the external power supply to the input of the on-board LDO (U11).
JU3	1-2	Connects the USB power to the input of the on-board LDO (U12).
	2-3*	Connects the external power supply to the input of the on-board LDO (U12).
JU4	1-2	Connects the USB power to the input of the on-board LDO (U13).
	2-3*	Connects the external power supply to the input of the on-board LDO (U13).
JU5	1-2*	The on-board LDO (U10) provides 3.3V output to the EV kit.
	Open	Disconnects the output of the on-board LDO (U10).
JU6	1-2*	The on-board LDO (U11) provides 1.8V output to the EV kit.
	Open	Disconnects the output of the on-board LDO (U11).
JU7	1-2*	The on-board LDO (U12) provides 2.5V output to the EV kit.
	Open	Disconnects the output of the on-board LDO (U12).
JU8	1-2*	The on-board LDO (U13) provides 1.2V output to the EV kit.
	Open	Disconnects the output of the on-board LDO (U13).

MAX11666 Evaluation Kit

Evaluates: MAX11666

Table 1. Jumper Settings (continued)

JUMPER	SHUNT POSITION	DESCRIPTION
JU10	1-2*	Connects the OVDD input of the ADC (U1) to the output of the on-board 3.3V LDO.
	2-3	Connects the OVDD input of the ADC (U1) to the OVDD connector.
JU11	1-2*	Connects the output of U17 (3.0V) to the REF input of the device.
	2-3	Connects the REF pin of the ADC (U1) to the REF connector.
JU12	1-2*	Connects the SCLK signal of the ADC (U1) to the FPGA.
	2-3	Connects the SCLK signal of the ADC (U1) to the SCLK connector.
JU13	1-2*	Connects the DOUT signal of the ADC (U1) to the FPGA.
	2-3	Connects the DOUT signal of the ADC (U1) to the DOUT connector.
JU14	1-2*	Connects the \overline{CS} signal of the ADC (U1) to the FPGA.
	2-3	Connects the \overline{CS} signal of the ADC (U1) to the \overline{CS} connector.
JU15	1-2*	Connects the CHSEL signal of the ADC (U1) to the FPGA.
	2-3	Connects the CHSEL signal of the ADC (U1) to the CHSEL connector.
JU16	1-2*	Connects the AVDD input of the ADC (U1) to the output of the on-board 3.3V LDO.
	2-3	Connects the AVDD input of the ADC (U1) to the AVDD connector.
JU17	1-2	Connects OP- to GND. Use this jumper if the negative supply is not available.
	Open*	Disconnects OP- from GND.
JU18	1-2*	Bypasses the on-board input buffer. Connects the AIN1_DC_SMA or the AIN1_DC connector to the AIN1 input of the ADC (U1).
	2-3	Connects the AIN1 input of the ADC (U1) to the output of the on-board buffer (U9).
JU19	1-2	Shorts the AC signal input to GND.
	Open*	Connects the signal from the AIN1_AC_SMA connector to the inverting input of the on-board buffer (U9) through a 1k Ω resistor.
JU20	1-2	Shorts the DC signal input to GND.
	Open*	Connects the signal from the AIN1_DC_SMA connector to the noninverting input of the on-board buffer (U9) through a 1k Ω resistor.
JU21	1-2*	Bypassing the on-board input buffer. Connects the AIN2_DC_SMA or the AIN2_DC connector to the AIN2 input of the ADC (U1).
	2-3	Connects the AIN2 input of the ADC (U1) to the output of the on-board buffer (U16).
JU22	1-2	Shorts the DC signal input to GND.
	Open*	Connects the signal from the AIN2_DC_SMA connector to the noninverting input of the on-board buffer (U16) through a 1k Ω resistor.
JU23	1-2	Shorts the AC signal input to GND.
	Open*	Connects the signal from the AIN2_AC_SMA connector to the inverting input of the on-board buffer (U16) through a 1k Ω resistor.

*Default position.

MAX11666 Evaluation Kit

Evaluates: MAX11666

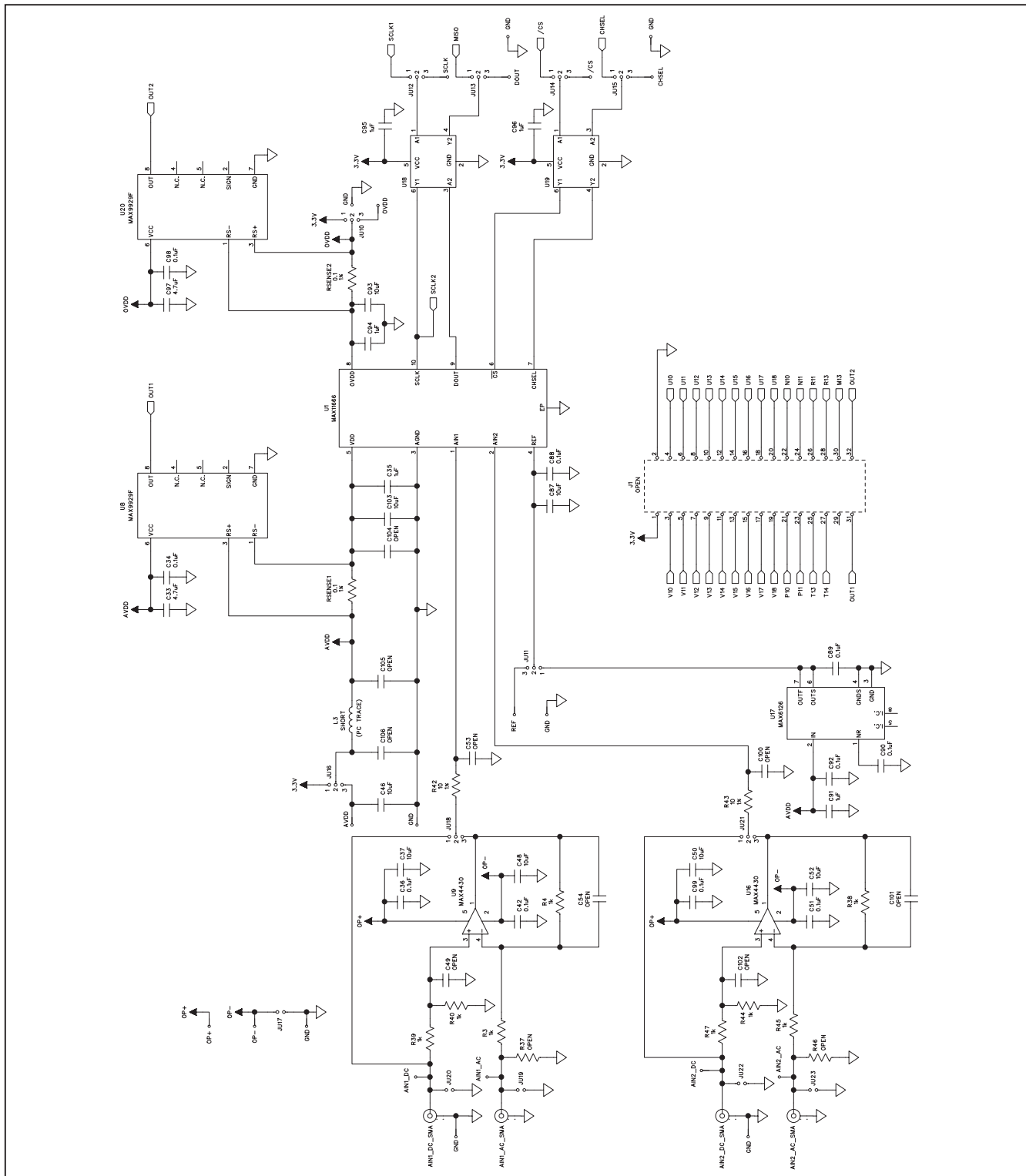

Figure 6a. MAX11666 EV Kit Schematic (Sheet 1 of 12)

MAX11666 Evaluation Kit

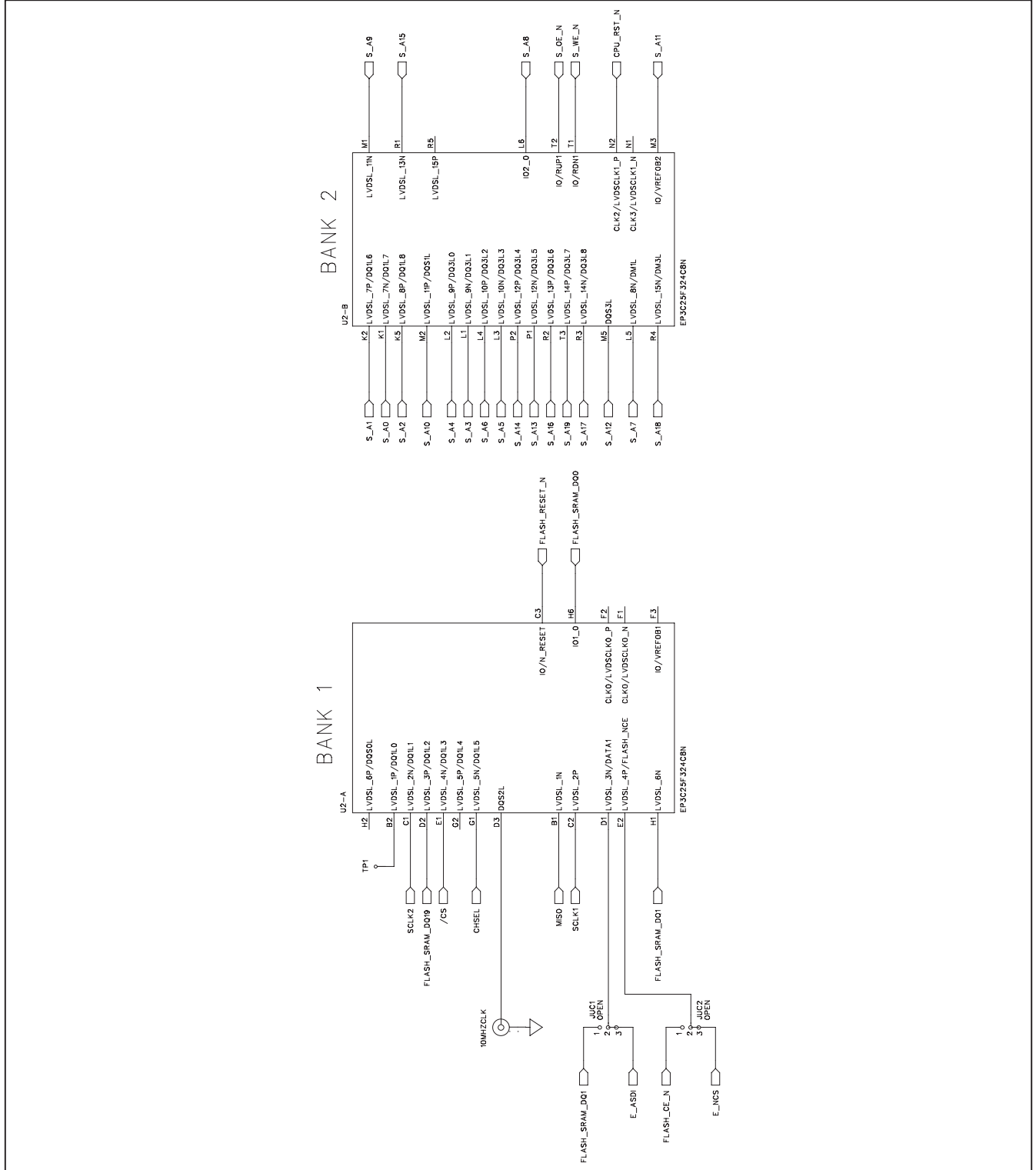

Figure 6b. MAX11666 EV Kit Schematic (Sheet 2 of 12)

MAX11666 Evaluation Kit

Evaluates: **MAX11666**

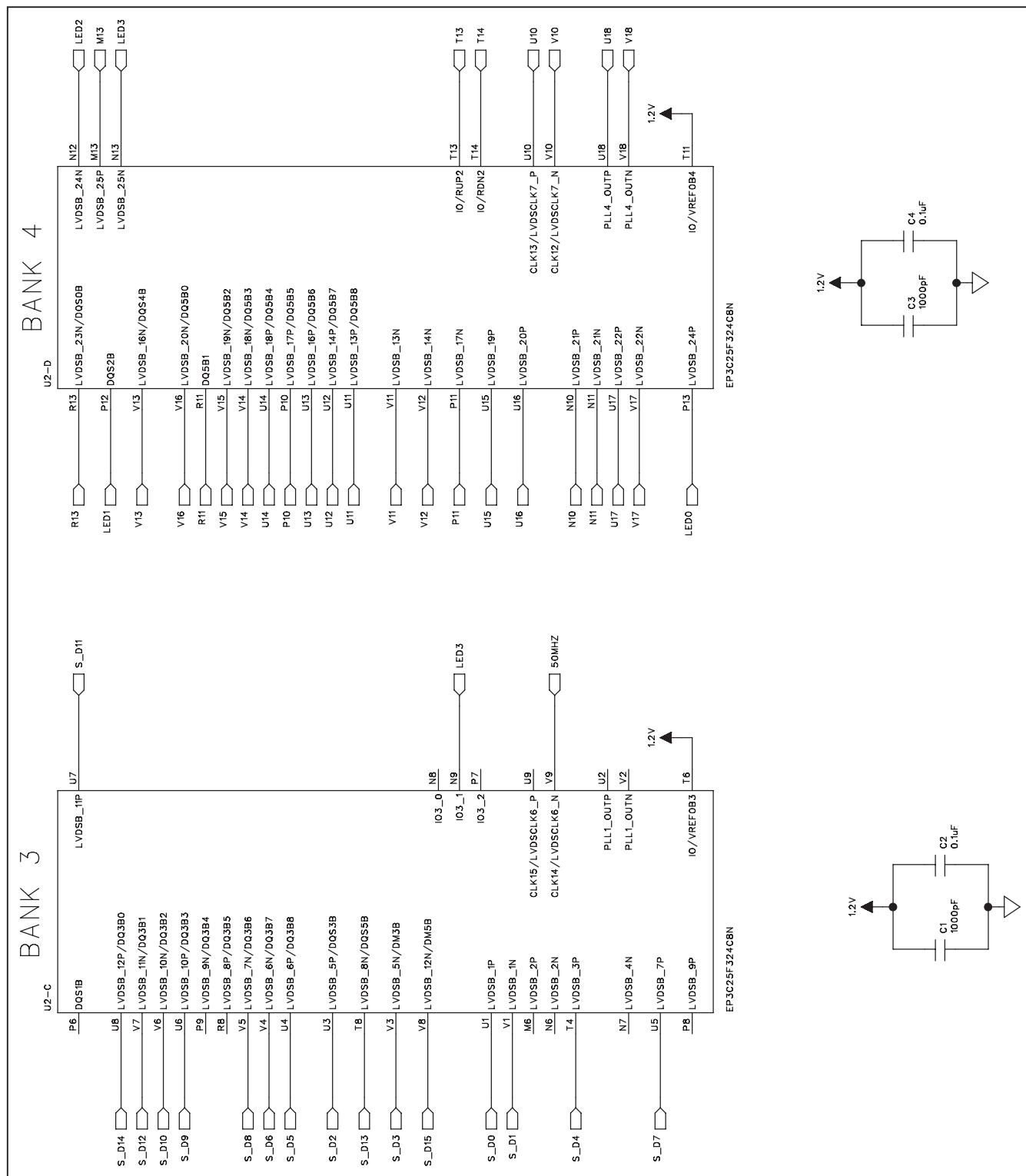

Figure 6c. MAX11666 EV Kit Schematic (Sheet 3 of 12)

MAX11666 Evaluation Kit

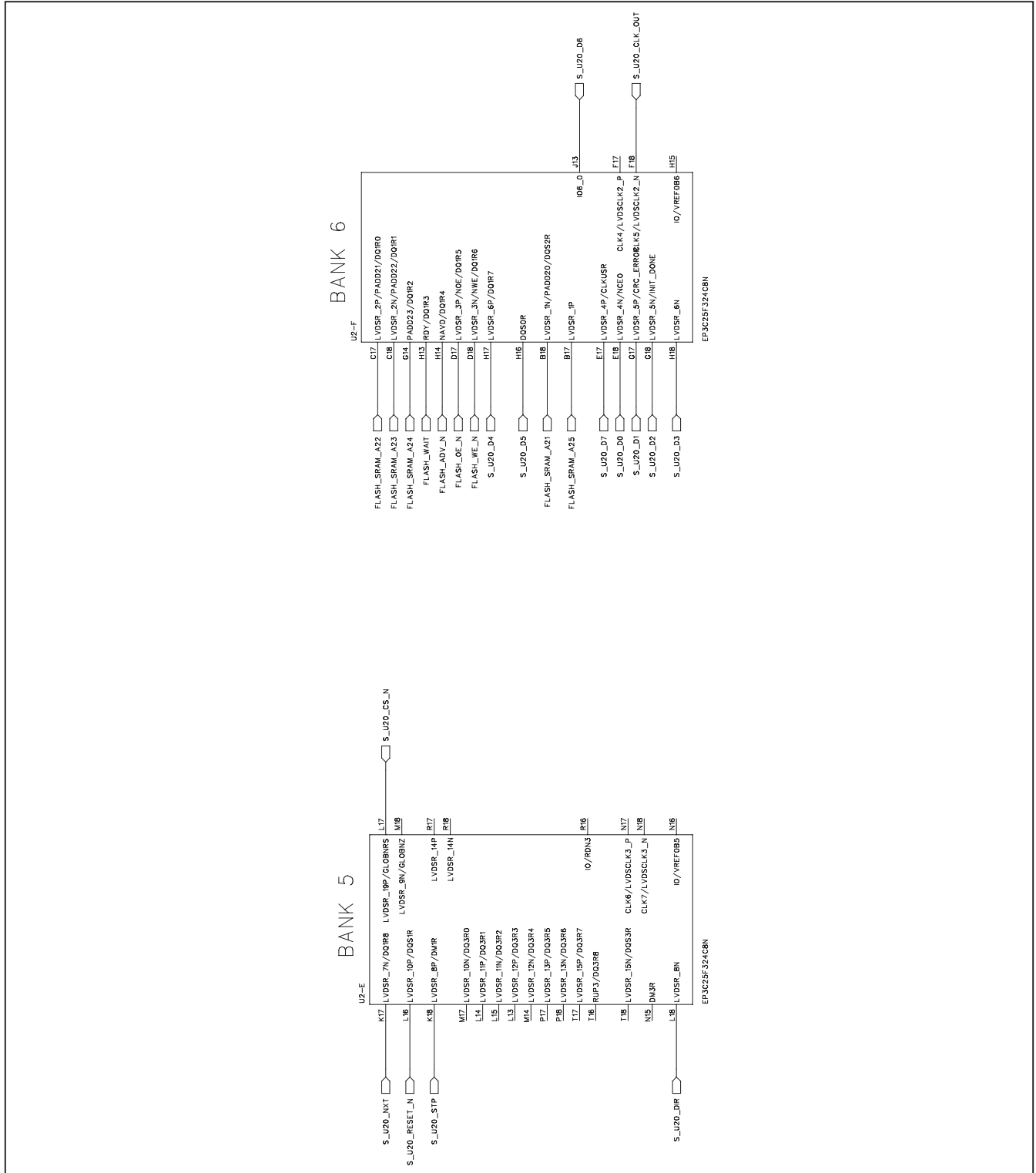

Figure 6d. MAX11666 EV Kit Schematic (Sheet 4 of 12)

MAX11666 Evaluation Kit

Evaluates: MAX11666

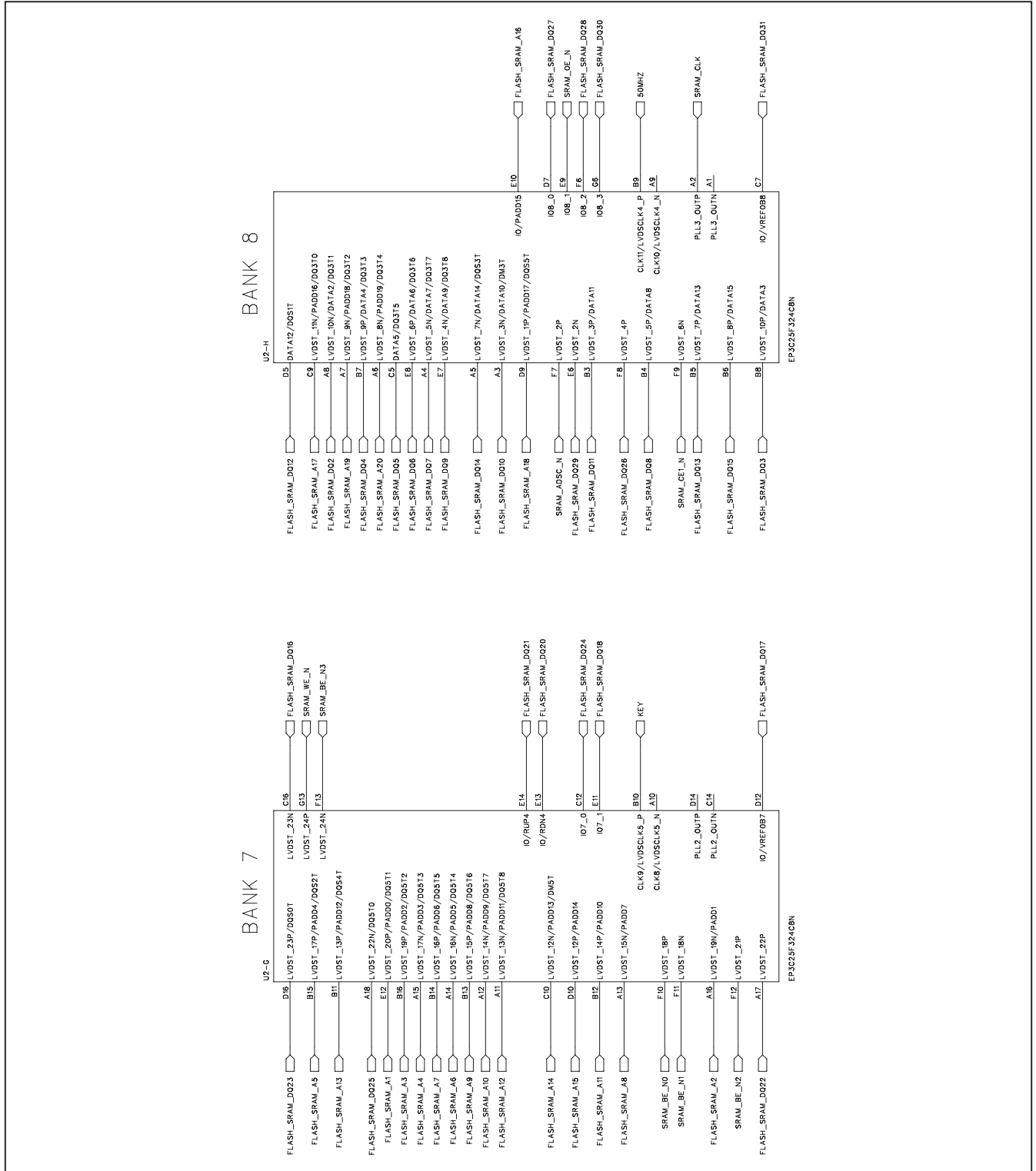

Figure 6e. MAX11666 EV Kit Schematic (Sheet 5 of 12)

MAX11666 Evaluation Kit

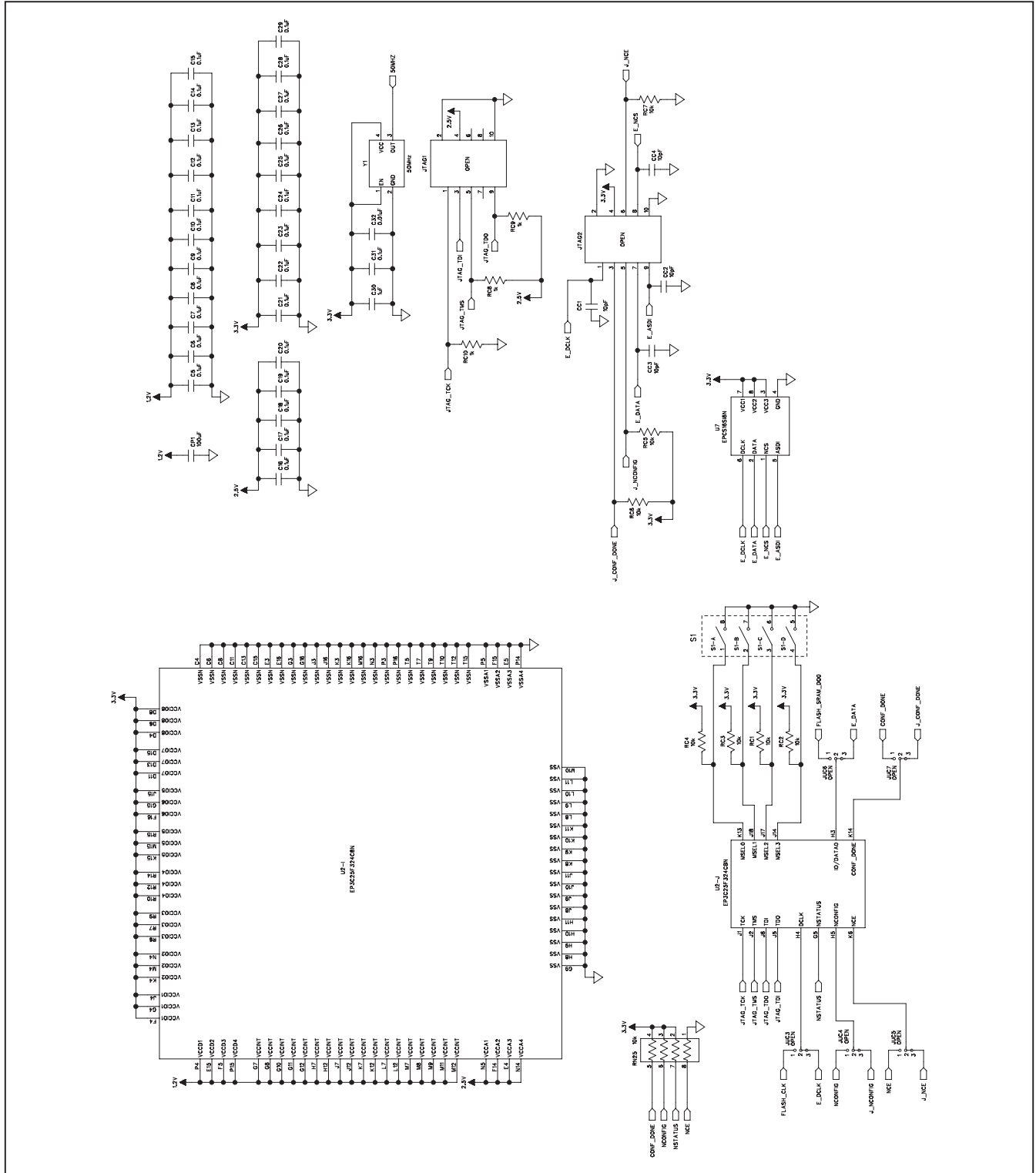

Figure 6f. MAX11666 EV Kit Schematic (Sheet 6 of 12)

MAX11666 Evaluation Kit

Evaluates: MAX11666

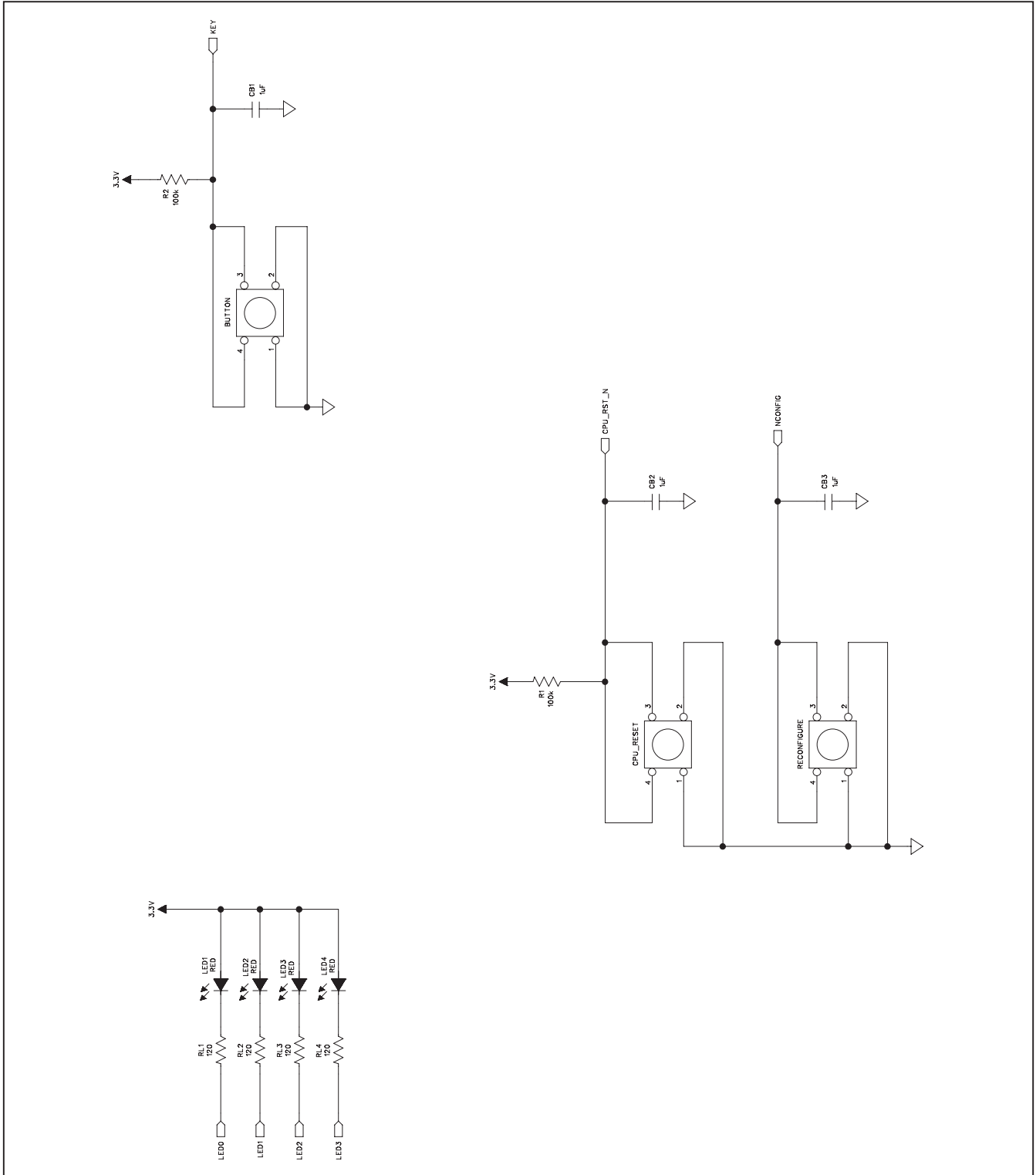

Figure 6g. MAX11666 EV Kit Schematic (Sheet 7 of 12)

MAX11666 Evaluation Kit

Place these terminations
in the middle of the line

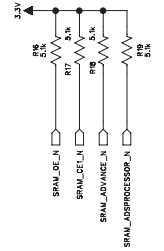
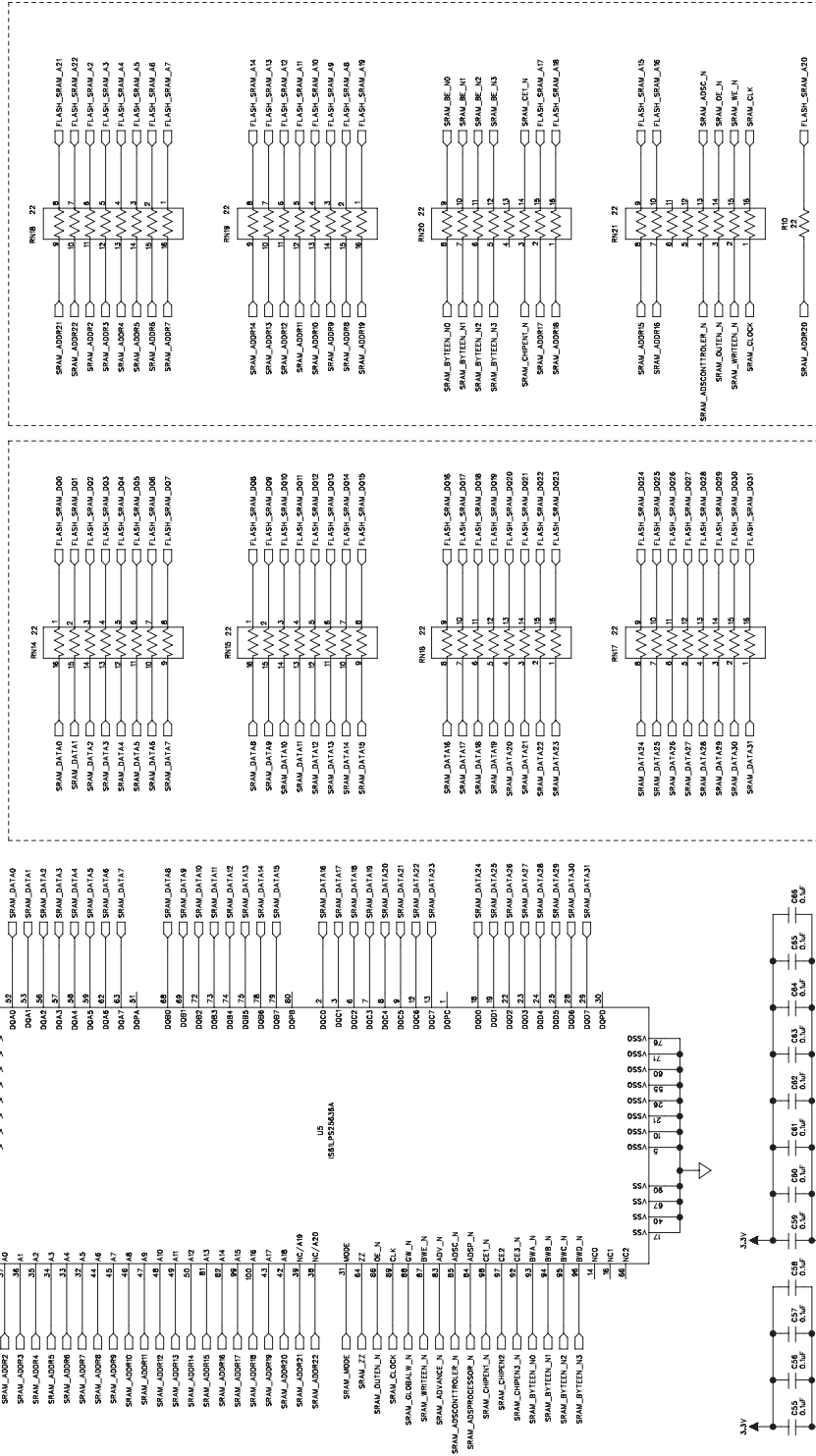

Figure 6h. MAX11666 EV Kit Schematic (Sheet 8 of 12)

MAX11666 Evaluation Kit

Evaluates: MAX11666

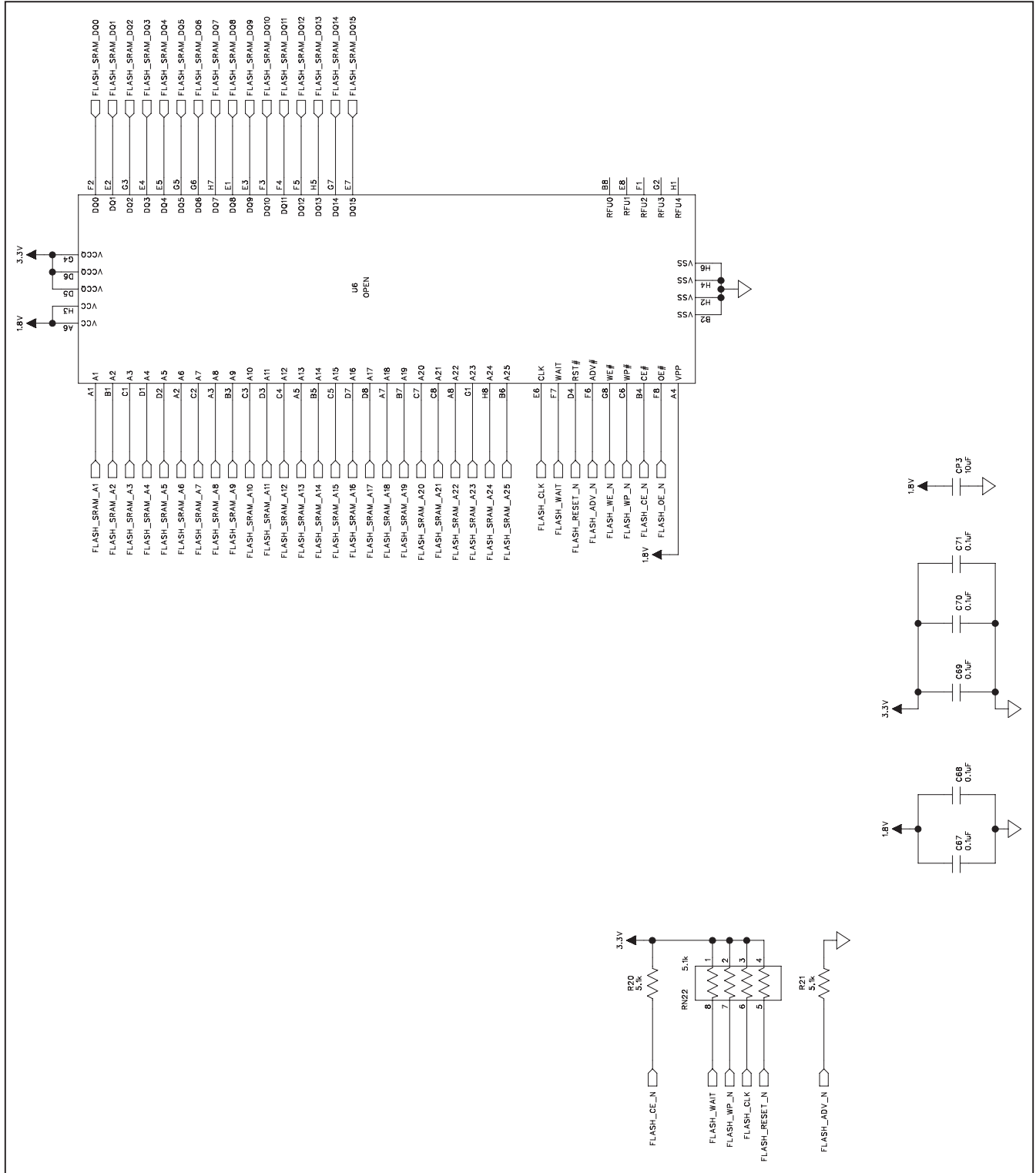
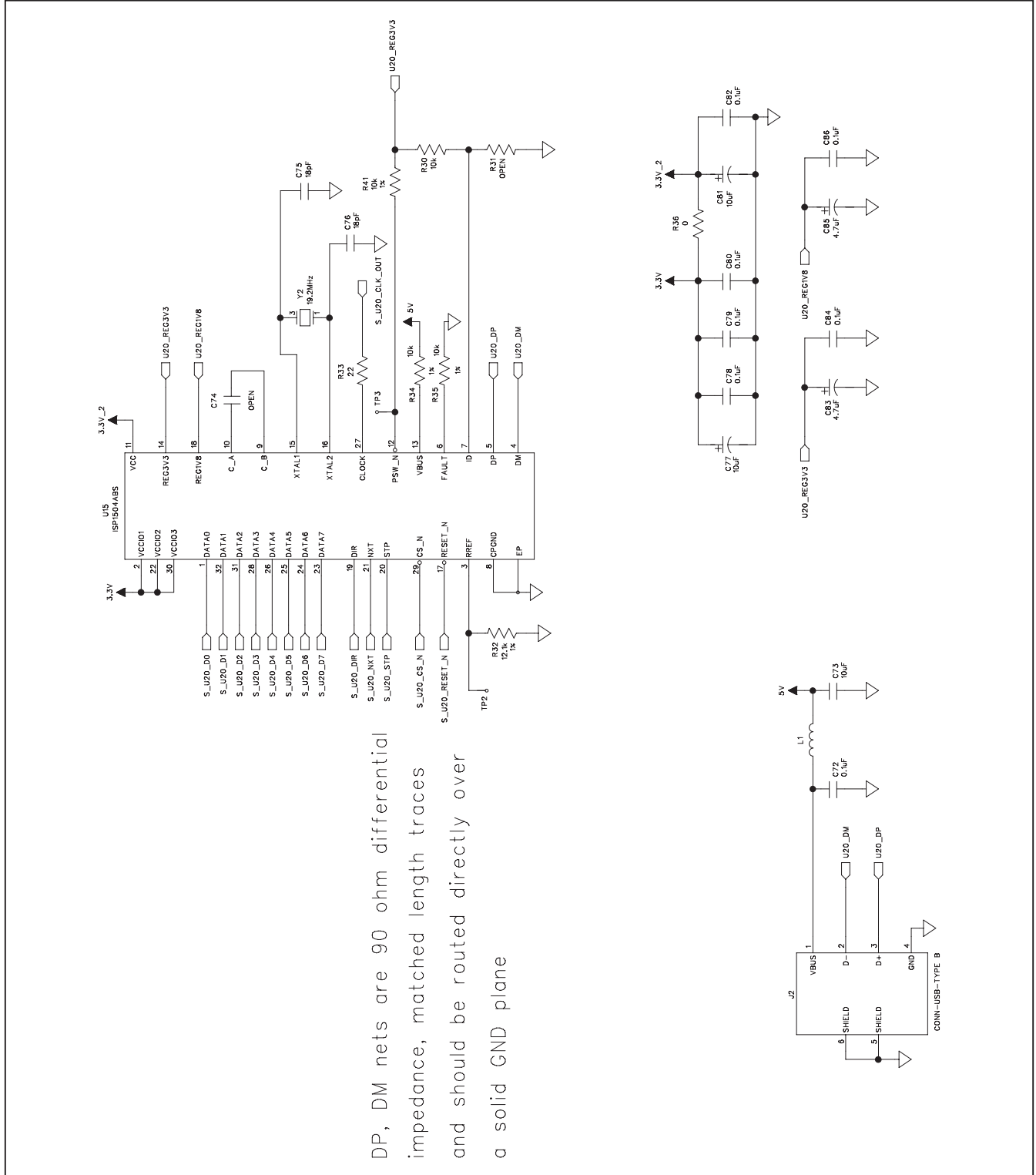

Figure 6i. MAX11666 EV Kit Schematic (Sheet 9 of 12)

MAX11666 Evaluation Kit



DP, DM nets are 90 ohm differential impedance, matched length traces and should be routed directly over a solid GND plane

Figure 6j. MAX11666 EV Kit Schematic (Sheet 10 of 12)

MAX11666 Evaluation Kit

Evaluates: MAX11666

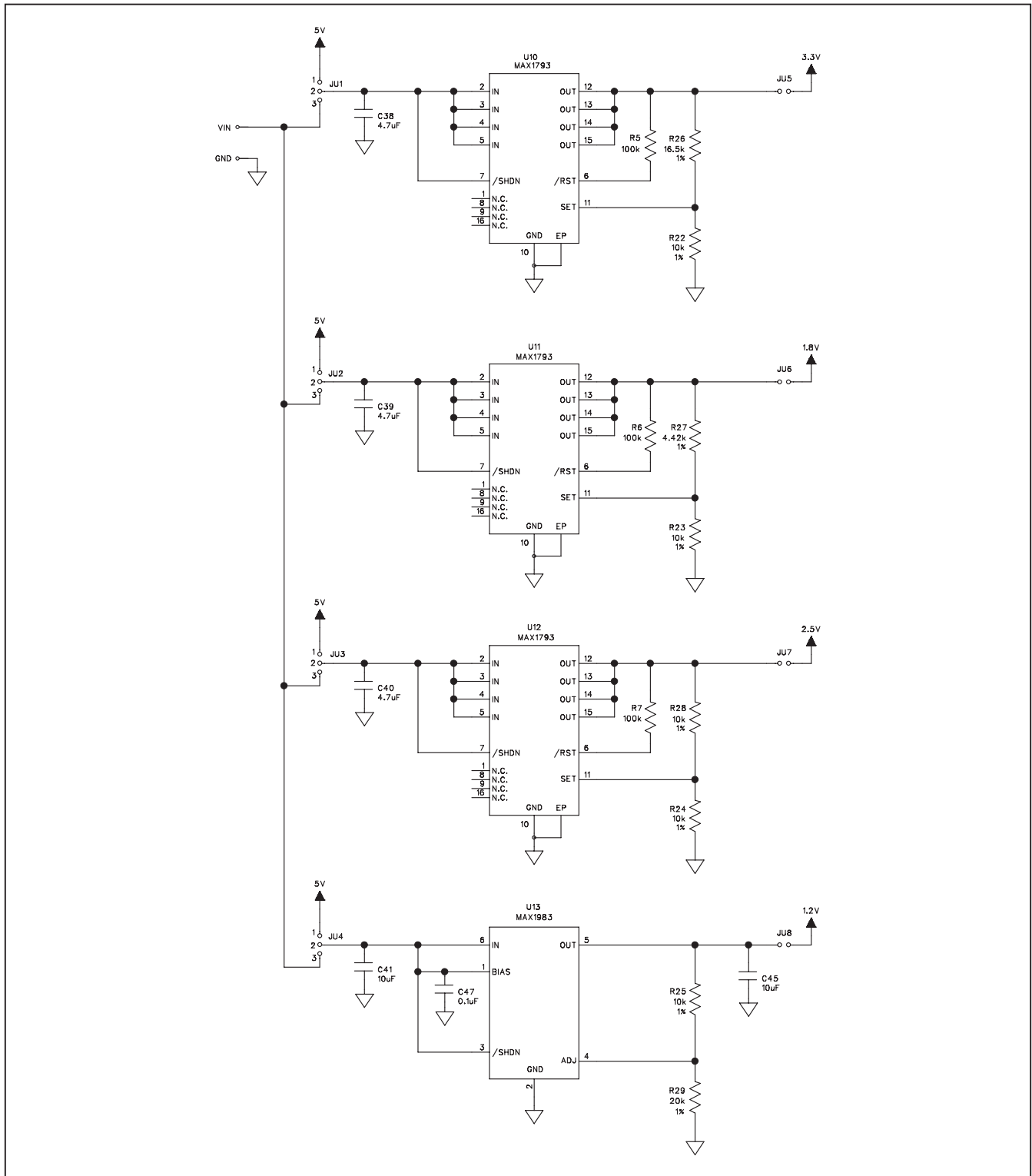

Figure 6k. MAX11666 EV Kit Schematic (Sheet 11 of 12)

MAX11666 Evaluation Kit

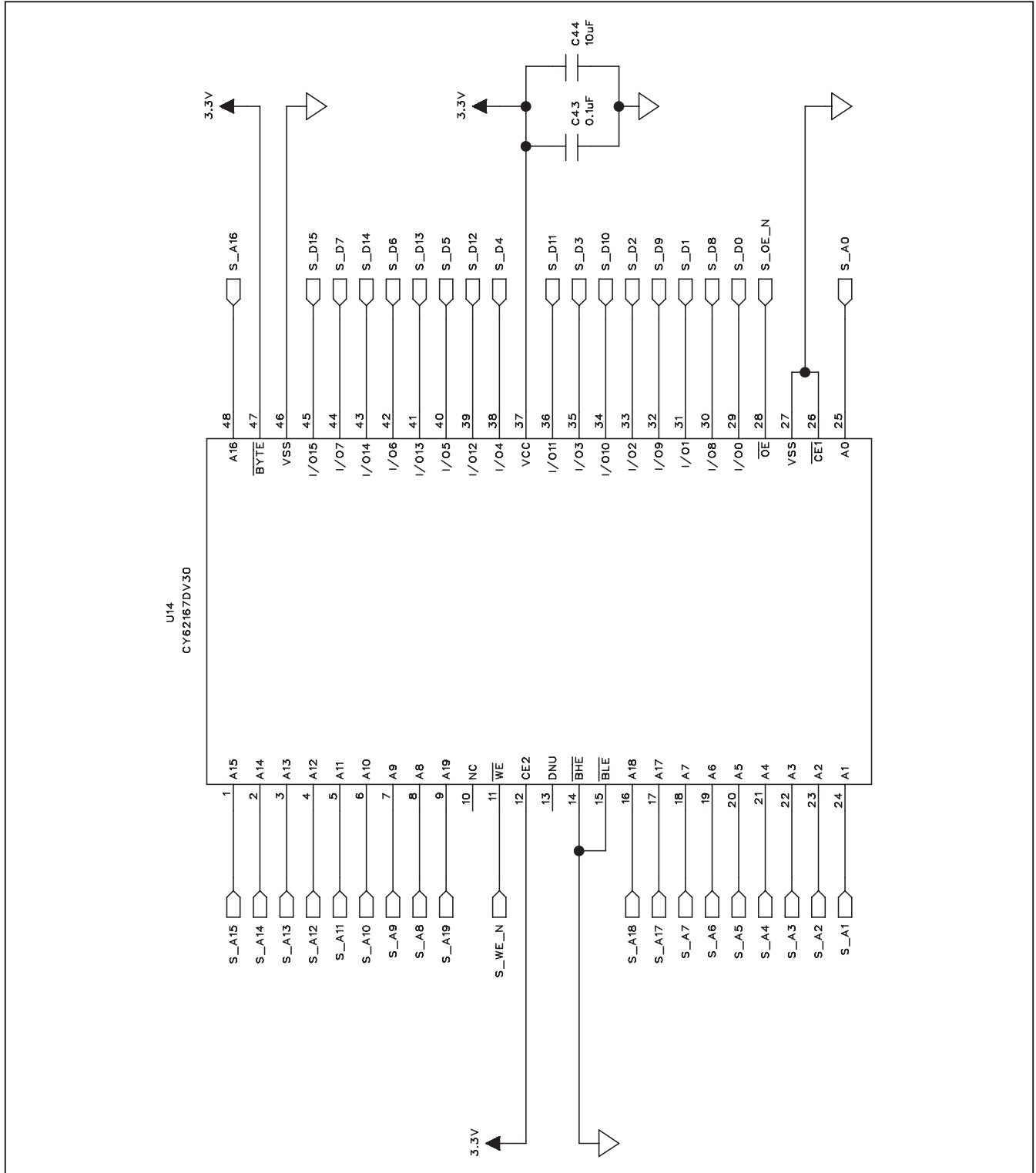

Figure 6I. MAX11666 EV Kit Schematic (Sheet 12 of 12)

MAX11666 Evaluation Kit

Evaluates: MAX11666

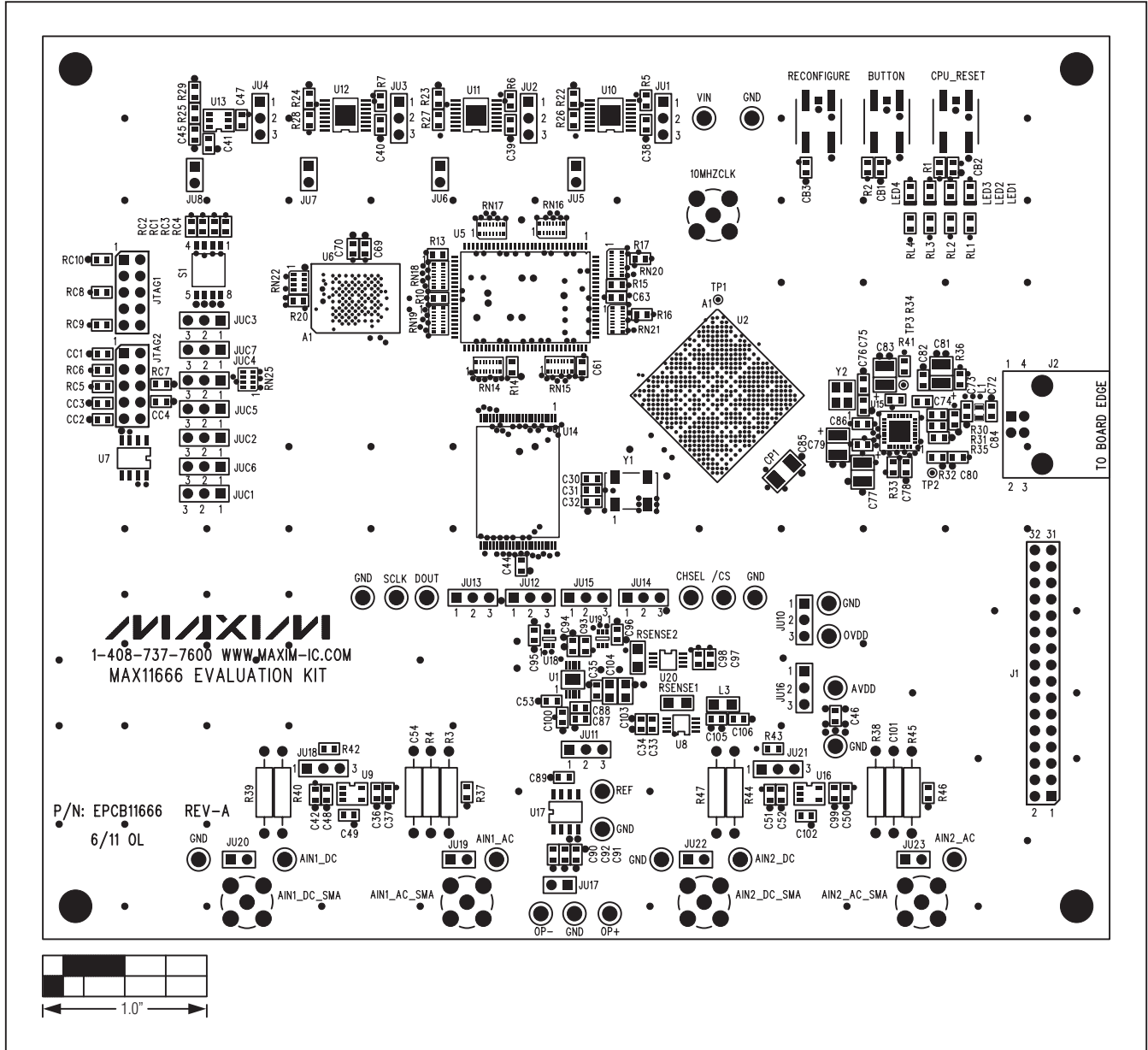

Figure 7. MAX11666 EV Kit Component Placement Guide—Top

MAX11666 Evaluation Kit

Evaluates: MAX11666

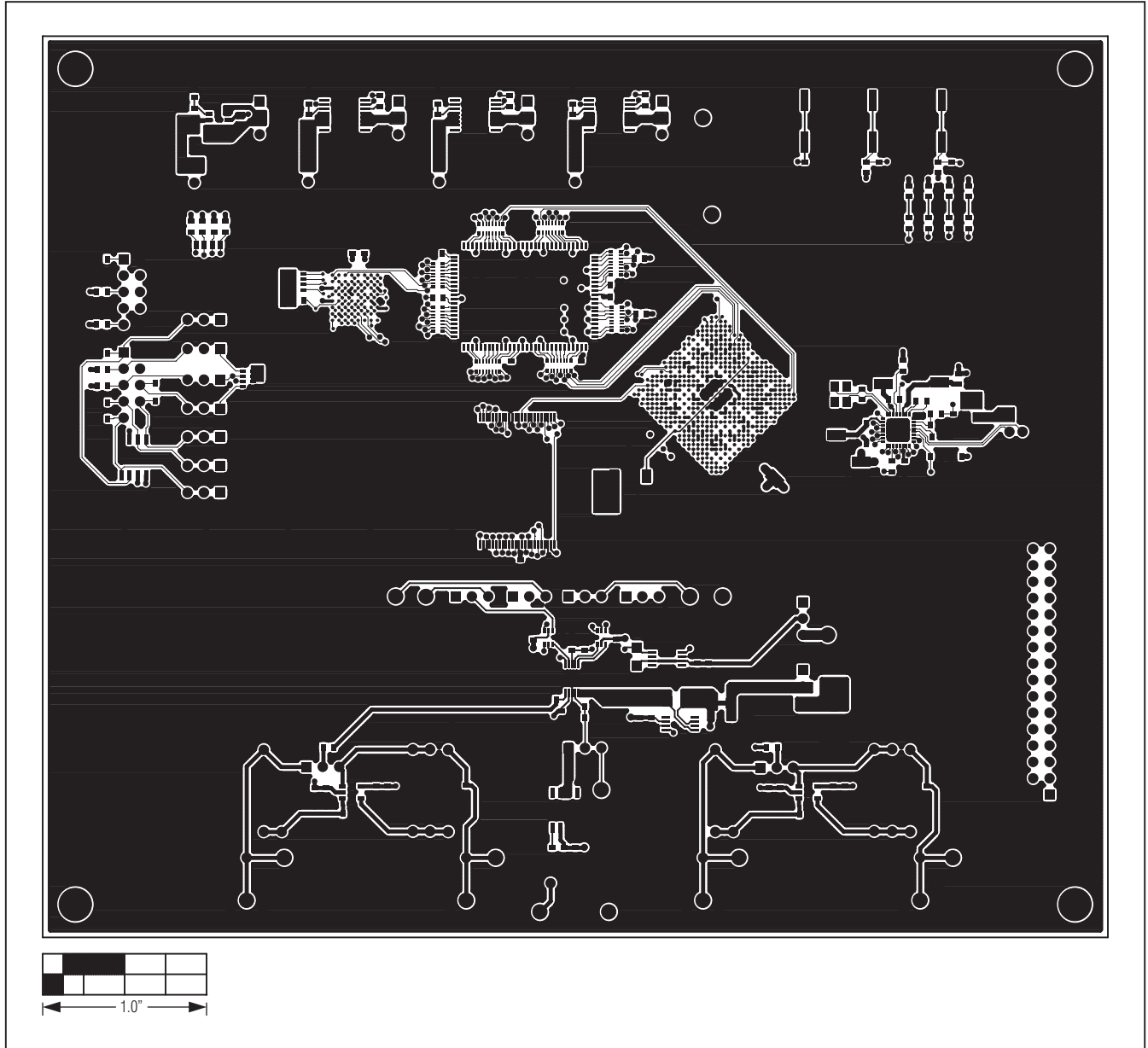

Figure 8. MAX11666 EV Kit PCB Layout—Component Side

MAX11666 Evaluation Kit

Evaluates: MAX11666

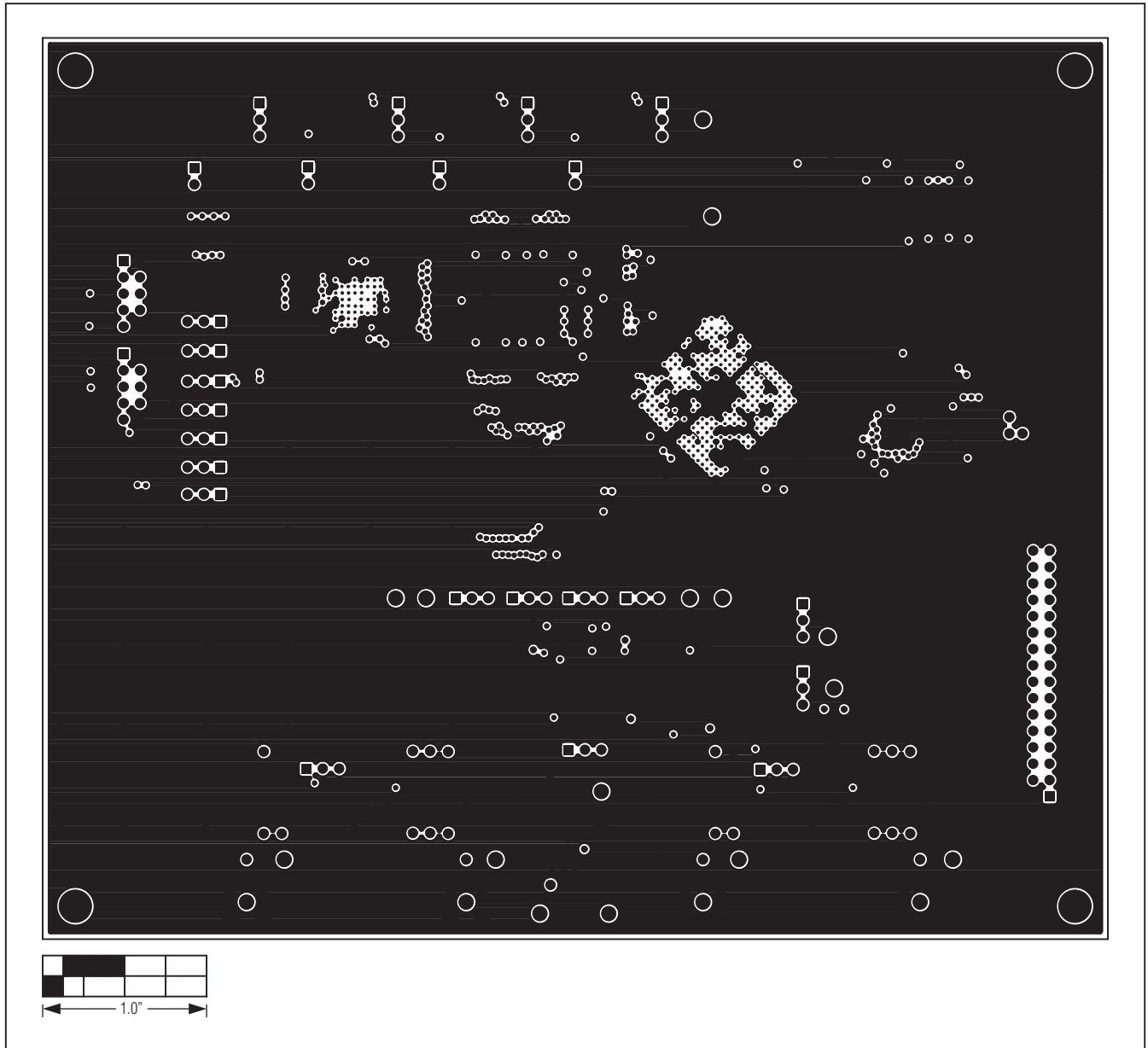

Figure 9. MAX11666 EV Kit PCB Layout—Layer 2

MAX11666 Evaluation Kit

Evaluates: MAX11666

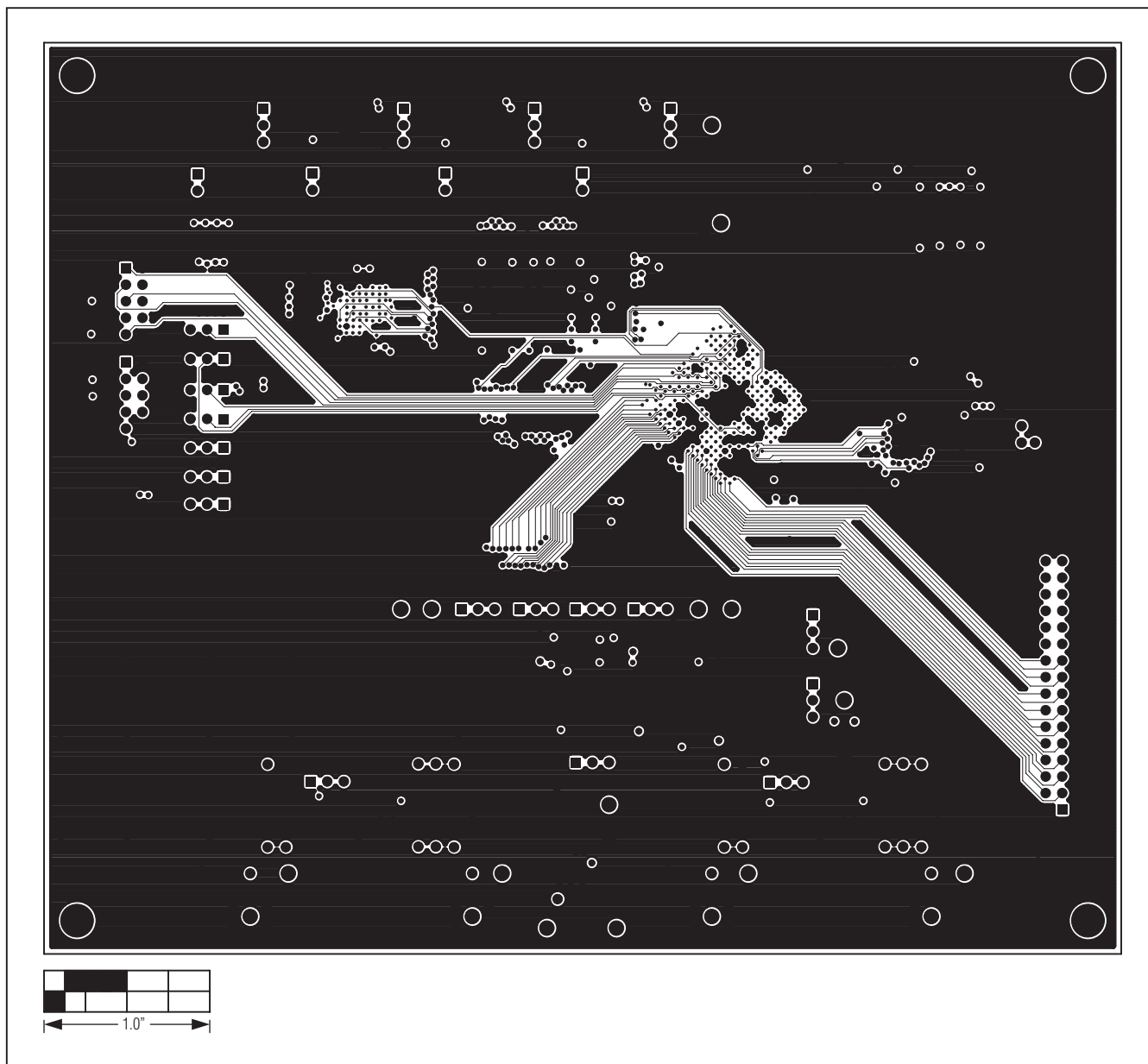

Figure 10. MAX11666 EV Kit PCB Layout—Layer 3

MAX11666 Evaluation Kit

Evaluates: MAX11666

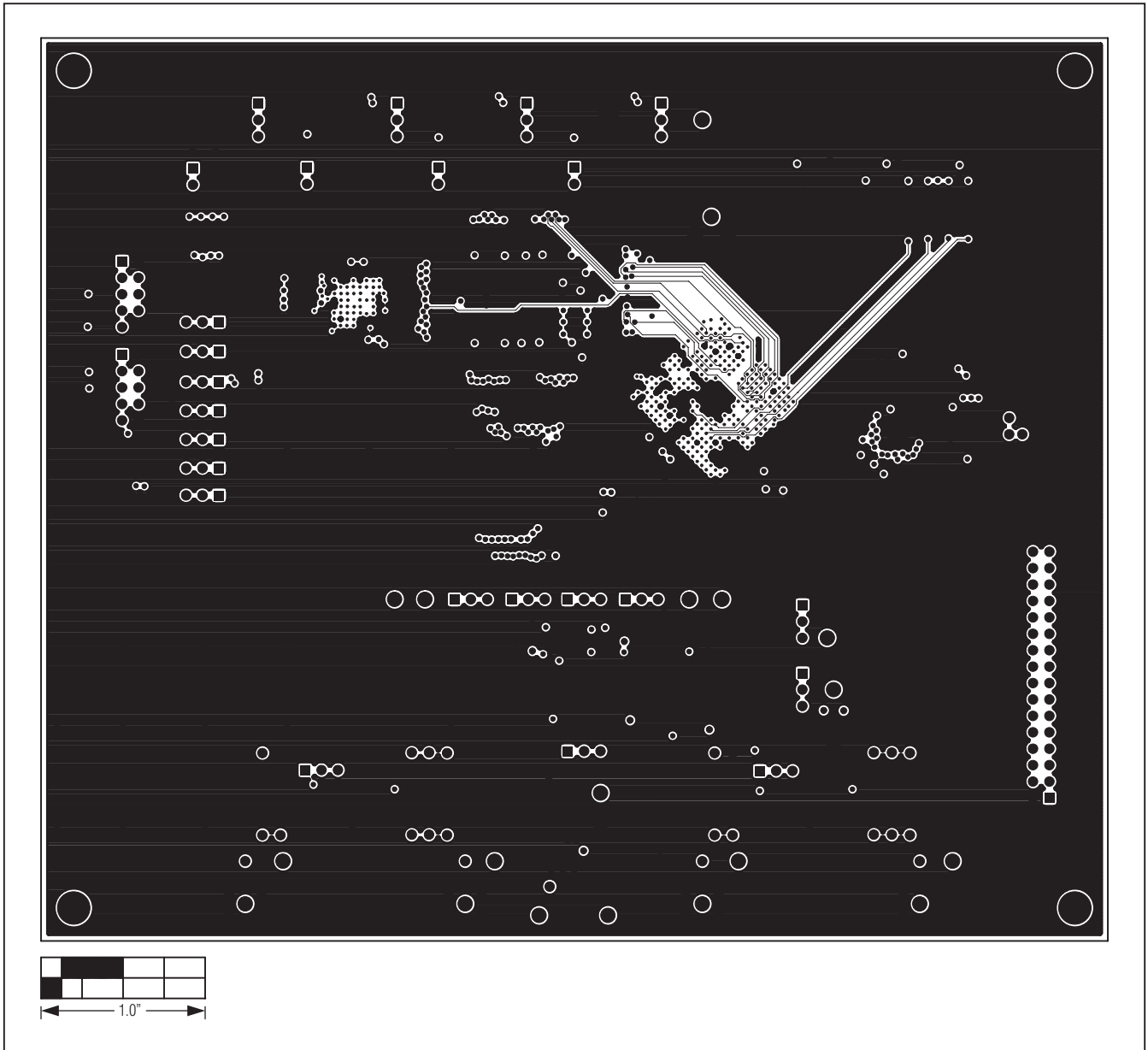

Figure 11. MAX11666 EV Kit PCB Layout—Layer 4

MAX11666 Evaluation Kit

Evaluates: MAX11666

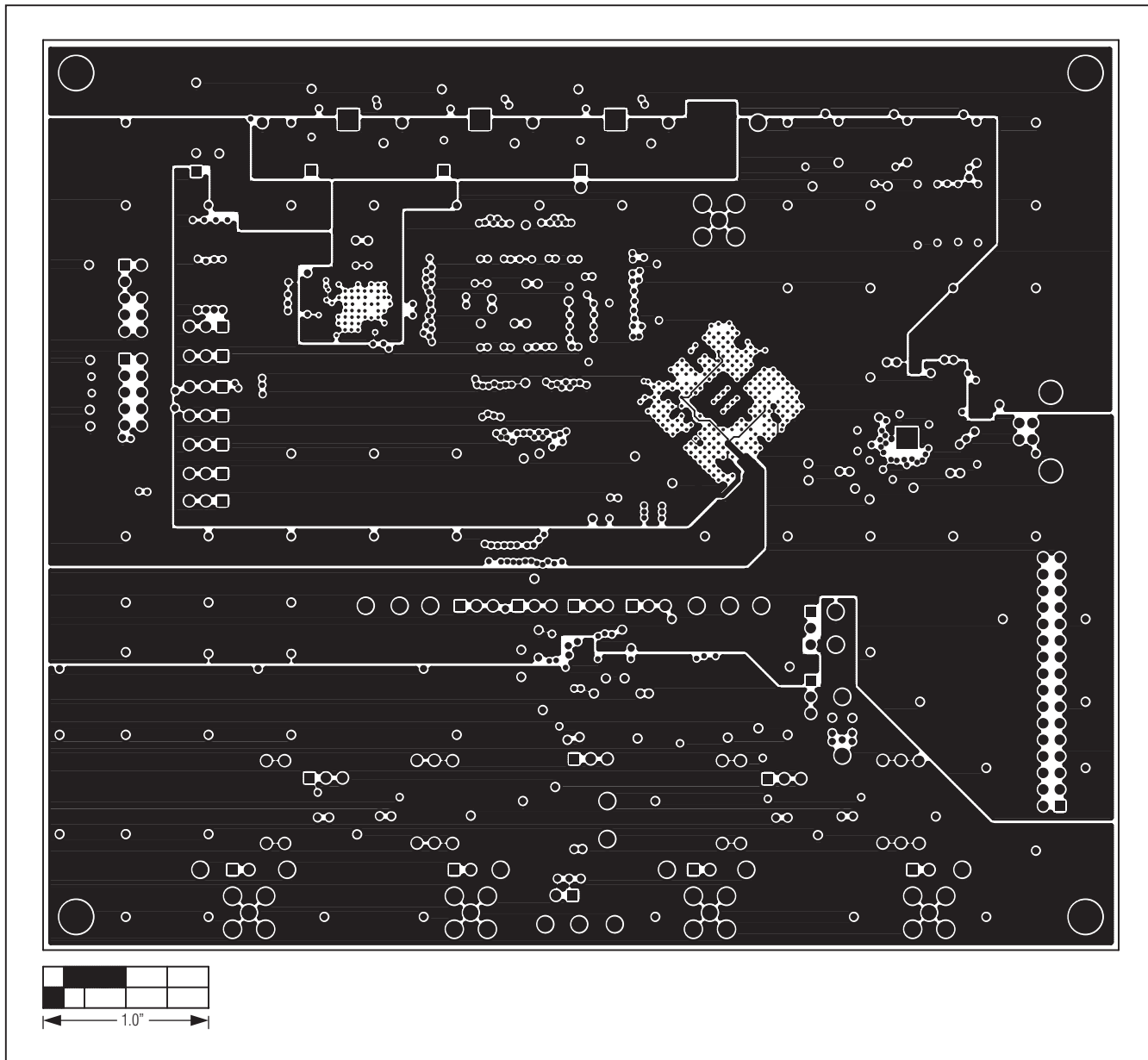

Figure 12. MAX11666 EV Kit PCB Layout—Layer 5

MAX11666 Evaluation Kit

Evaluates: MAX11666

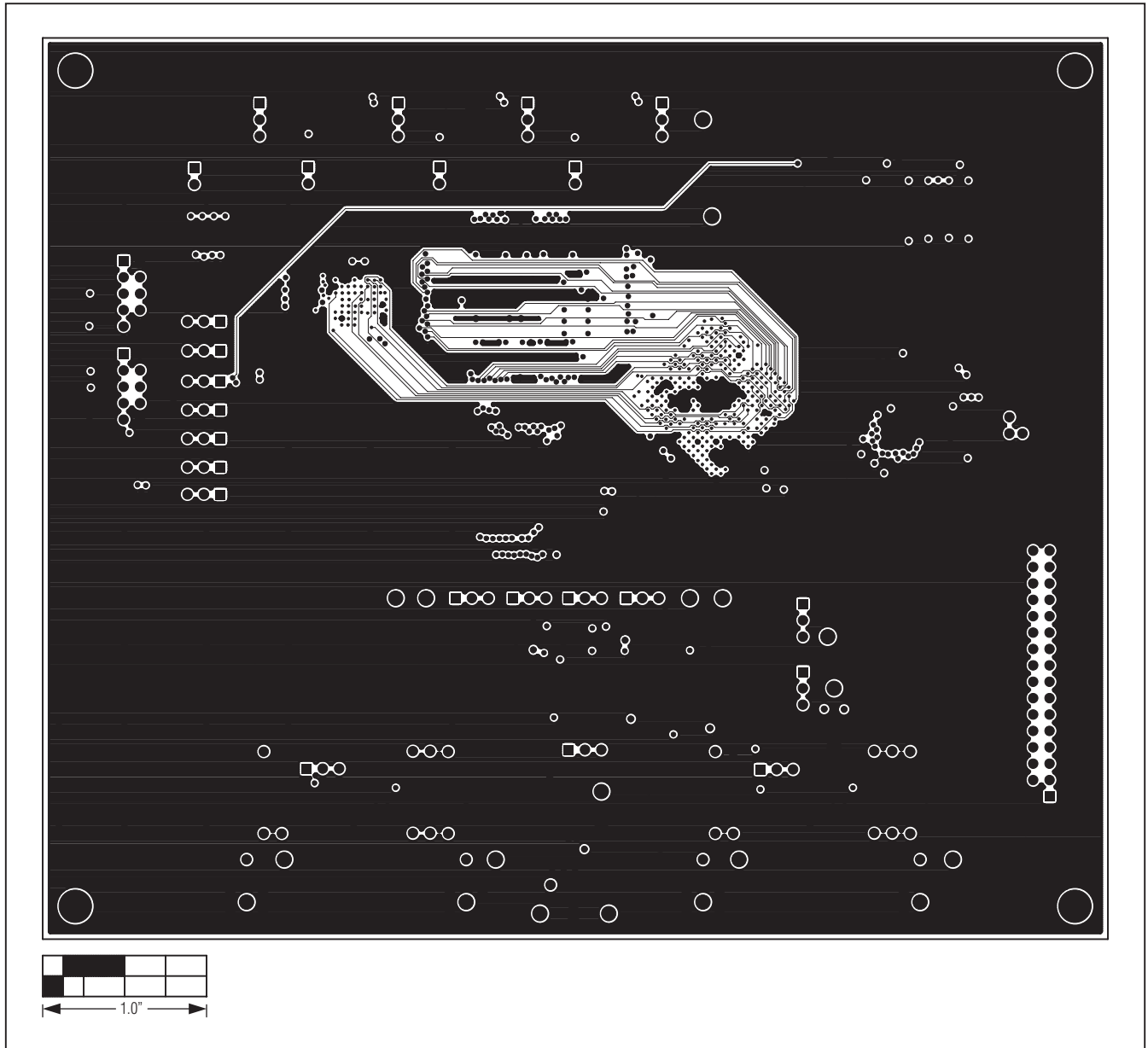

Figure 13. MAX11666 EV Kit PCB Layout—Layer 6

MAX11666 Evaluation Kit

Evaluates: MAX11666

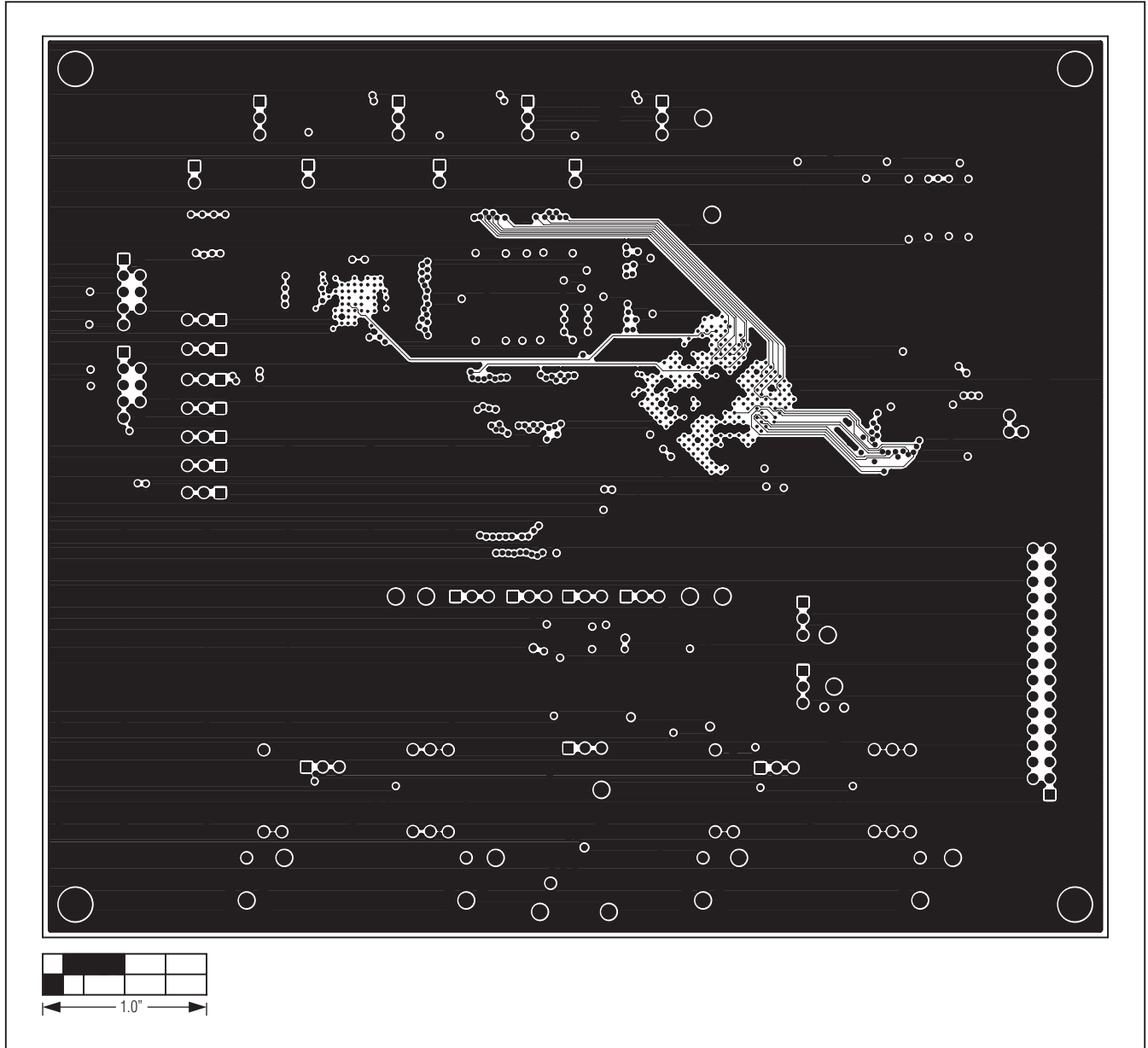

Figure 14. MAX11666 EV Kit PCB Layout—Layer 7

MAX11666 Evaluation Kit

Evaluates: MAX11666

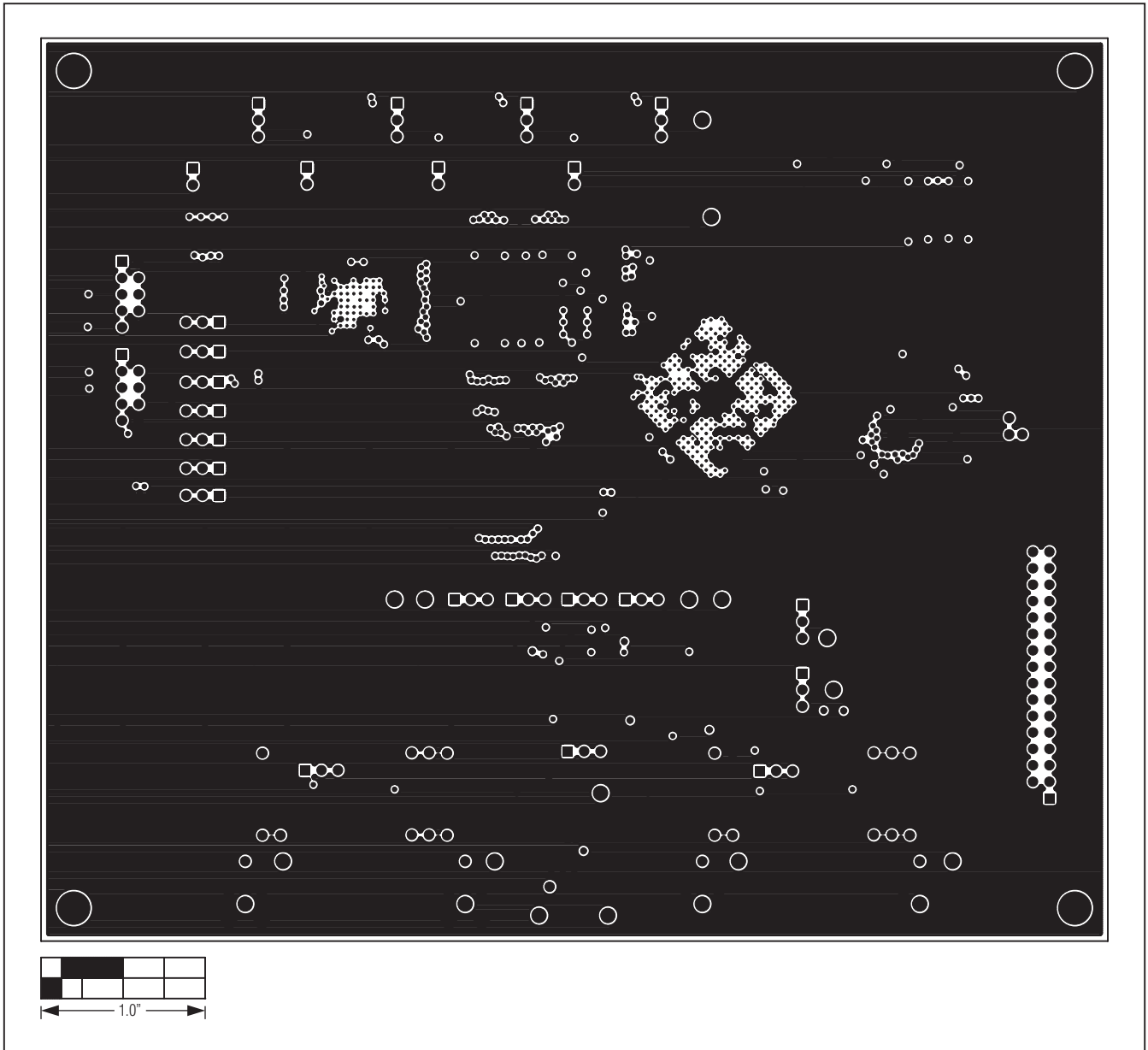

Figure 15. MAX11666 EV Kit PCB Layout—Layer 8

MAX11666 Evaluation Kit

Evaluates: MAX11666

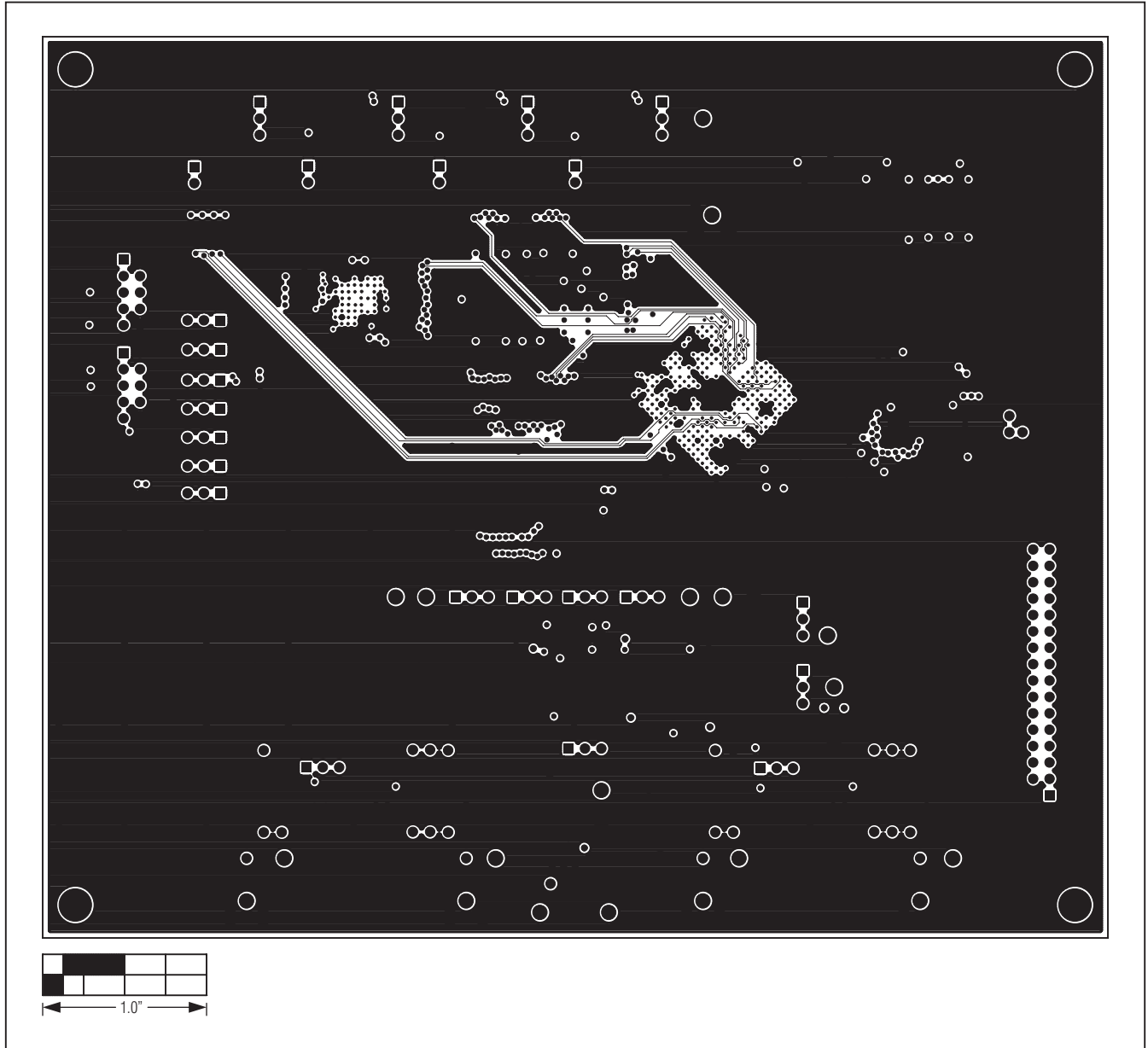

Figure 16. MAX11666 EV Kit PCB Layout—Layer 9

MAX11666 Evaluation Kit

Evaluates: MAX11666

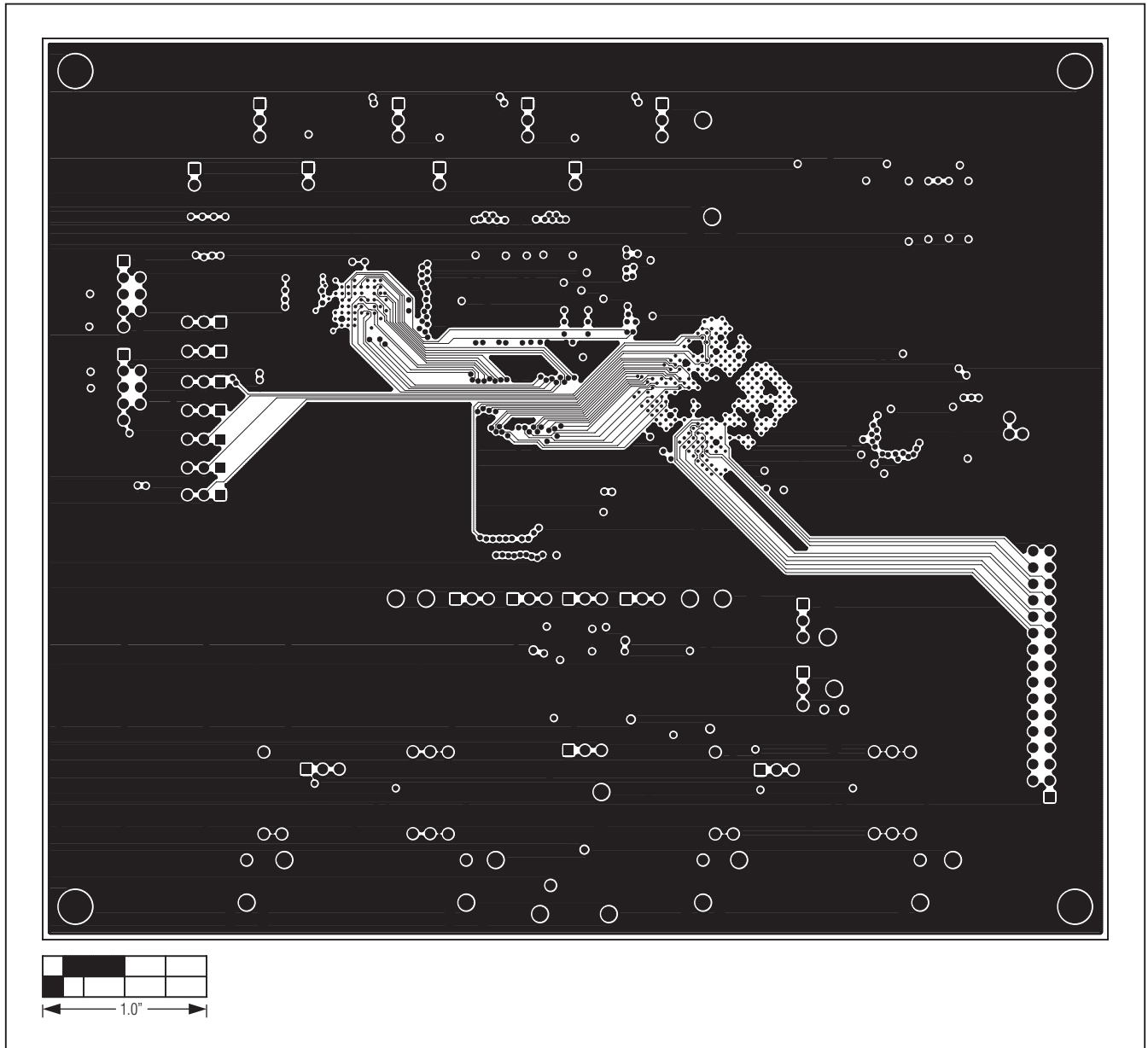

Figure 17. MAX11666 EV Kit PCB Layout—Layer 10

MAX11666 Evaluation Kit

Evaluates: MAX11666

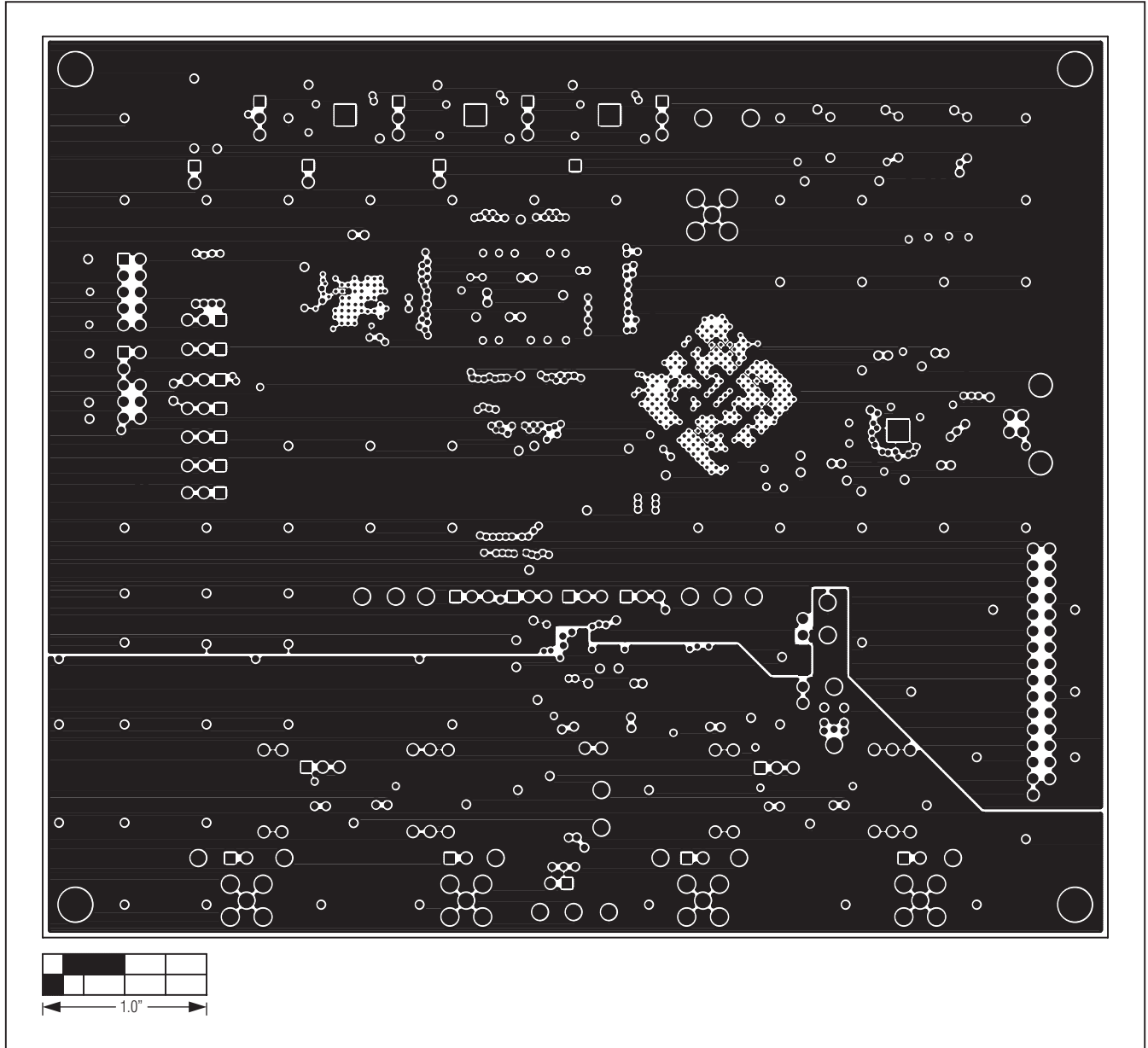

Figure 18. MAX11666 EV Kit PCB Layout—Layer 11

MAX11666 Evaluation Kit

Evaluates: MAX11666

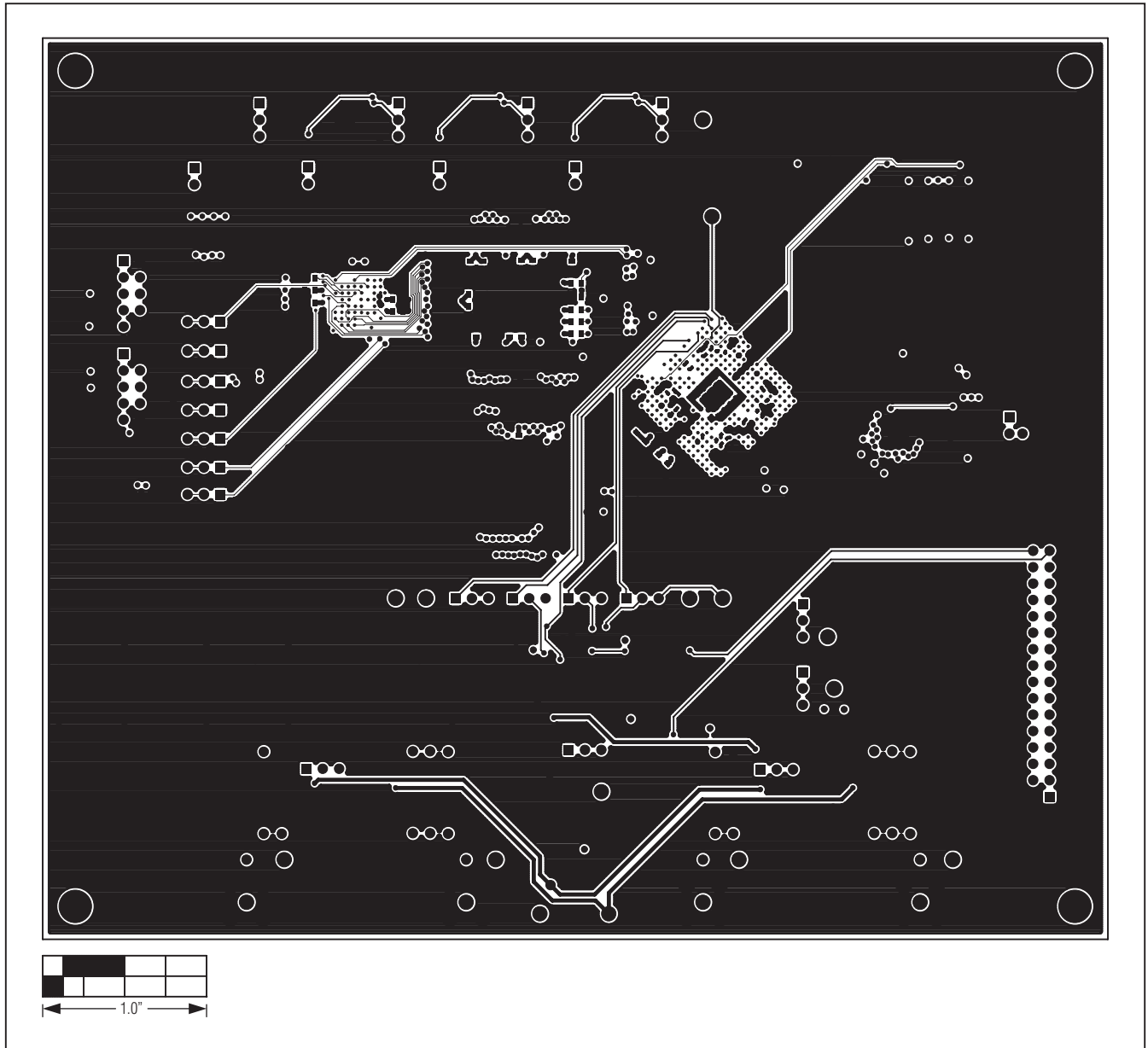

Figure 19. MAX11666 EV Kit PCB Layout— Bottom Side

MAX11666 Evaluation Kit

Evaluates: MAX11666

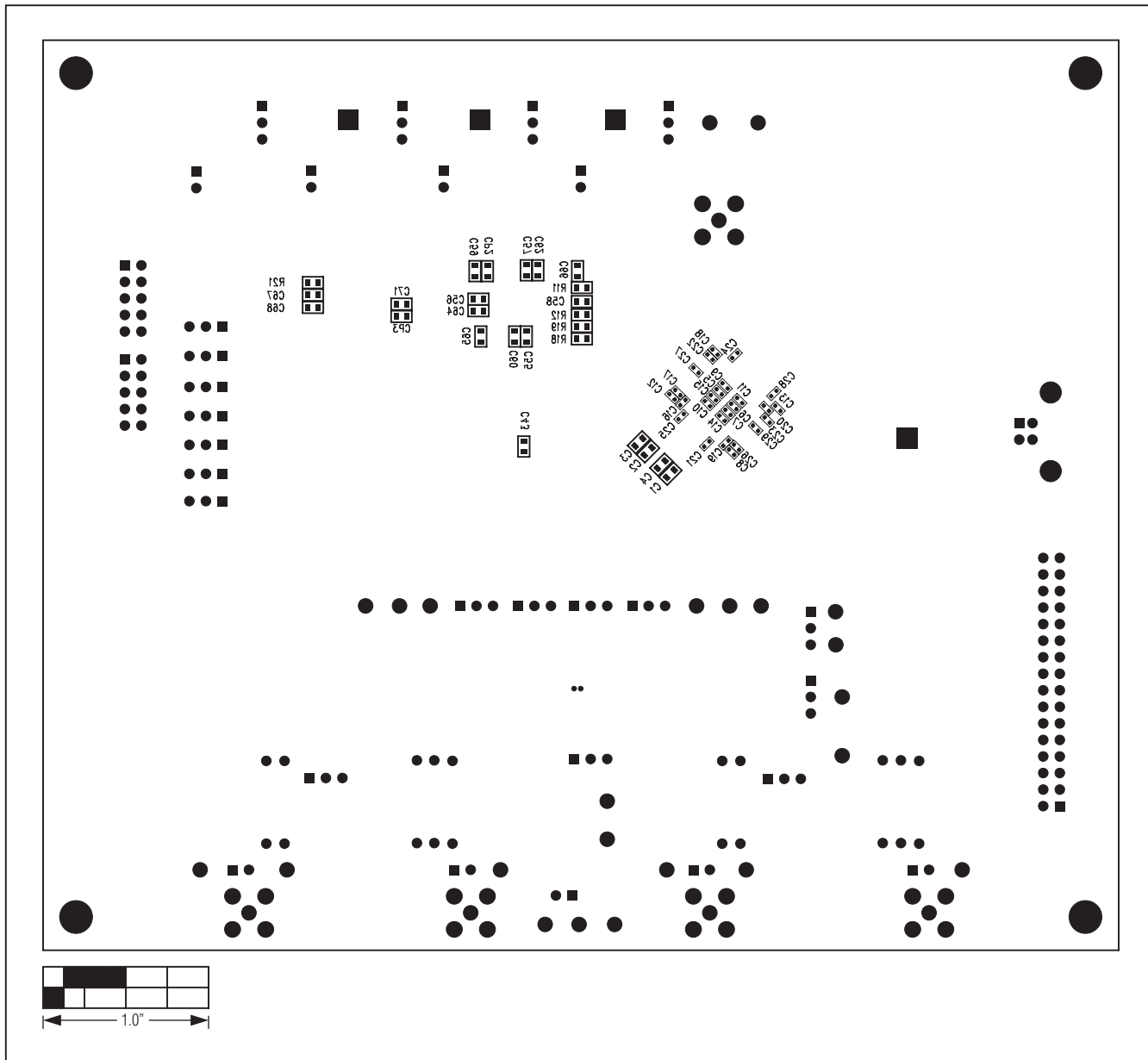

Figure 20. MAX11666 EV Kit Component Placement Guide—Bottom

MAX11666 Evaluation Kit

Revision History

REVISION NUMBER	REVISION DATE	DESCRIPTION	PAGES CHANGED
0	6/11	Initial release	—

Evaluates: MAX11666

Maxim cannot assume responsibility for use of any circuitry other than circuitry entirely embodied in a Maxim product. No circuit patent licenses are implied. Maxim reserves the right to change the circuitry and specifications without notice at any time.

Maxim Integrated Products, 120 San Gabriel Drive, Sunnyvale, CA 94086 408-737-7600 _____ 39