

UNCONTROLLED DOCUMENT

PART NUMBER		REV.
SML-LXL1307SRC-TR		A
REV.	E.C.N. NUMBER AND REVISION COMMENTS	DATE
A	E.C.N. #10909.	9.17.02

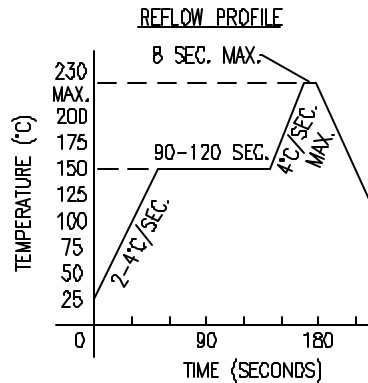
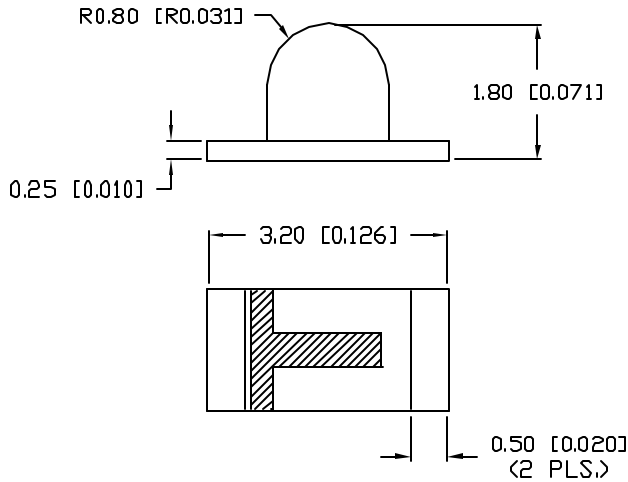
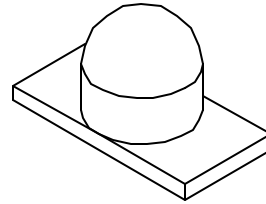
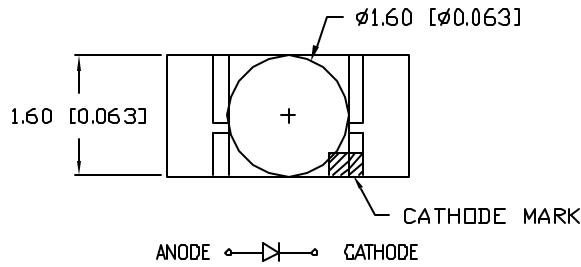

ELECTRO-OPTICAL CHARACTERISTICS $T_A=25^\circ\text{C}$ $I_f=20\text{mA}$

PARAMETER	MIN	TYP	MAX	UNITS	TEST COND
PEAK WAVELENGTH		660		nm	
FORWARD VOLTAGE		1.7	2.2	V_f	
REVERSE VOLTAGE	4.0			V_r	$I_f=100\mu\text{A}$
AXIAL INTENSITY		300		mcd	$I_f=20\text{mA}$
VIEWING ANGLE		50		2x theta	
EMITTED COLOR:	RED				
EPOXY LENS FINISH:	WATER CLEAR				

LIMITS OF SAFE OPERATION AT 25°C

PARAMETER	MAX	UNITS
PEAK FORWARD CURRENT*	150	mA
STEADY CURRENT	30	mA
POWER DISSIPATION	105	mW
DERATE FROM 25°C	-1.6	mW/°C
OPERATING, STORAGE TEMP.	-40 TO +85	°C

* $t < 10\mu\text{s}$

NOTES:

- 2,000 PIECES PER REEL.
- THE POLARITY MARK IS ORIENTED TOWARDS THE TAPE SPROCKET HOLE.

CAUTION: MOISTURE SENSITIVE DEVICE

- SHELF LIFE IN SEALED BAG:
12 MONTHS AT $<40^\circ\text{C}$ AND $<90\%$ RELATIVE HUMIDITY (RH).
- AFTER THIS BAG IS OPENED, DEVICES HAVE TO BE MOUNTED WITHIN 48 HOURS OR STORED AT $<30\%$ RH.

RECOMMENDED SOLDER PAD LAYOUT

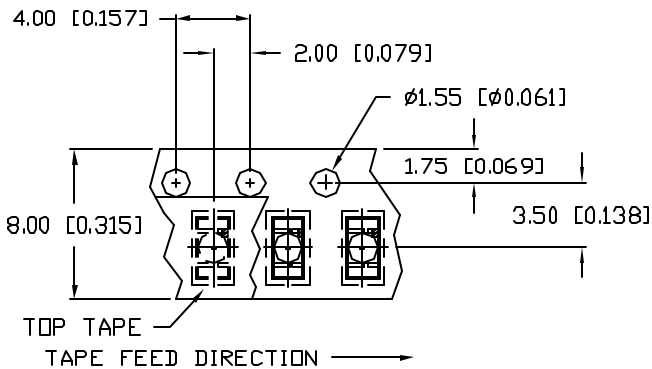
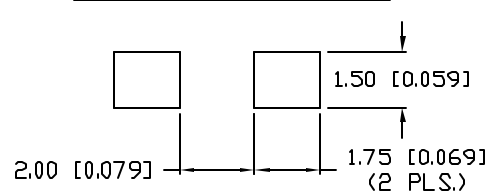

*UNLESS OTHERWISE SPECIFIED TOLERANCES PER DECIMAL PRECISION ARE: X=±1 (±0.039), XX=±0.5 (±0.020), XXX=±0.25 (±0.010), XXXX=±0.127 (±0.005), LEAD SIZE=±0.05 (0.002), LEAD LENGTH=±0.75 (±0.030), MIN= +DECIMAL PRECISION -0.00, MAX.= +0.00 -DECIMAL PRECISION

UNCONTROLLED DOCUMENT

REV.	PART NUMBER	CONFIDENTIAL INFORMATION		 290 E. HELEN ROAD PALATINE, IL 60067-6976 PHONE: +1.847.359.2790 US WEB: www.lumex.com TW WEB: www.lumex.com.tw
A	SML-LXL1307SRC-TR	THE INFORMATION CONTAINED IN THIS DOCUMENT IS THE PROPERTY OF LUMEX INC. EXCEPT AS SPECIFICALLY AUTHORIZED IN WRITING BY LUMEX INC., THE HOLDER OF THIS DOCUMENT SHALL KEEP ALL INFORMATION CONTAINED HEREIN CONFIDENTIAL AND SHALL PROTECT SAME IN WHOLE OR IN PART FROM DISCLOSURE AND DISSEMINATION TO ALL THIRD PARTIES. RELIABILITY NOTE OUR MANY YEARS OF EXPERIENCE DATA ACCUMULATION INDICATE THAT SOLDER HEAT IS A MAJOR CAUSE OF EARLY AND FUTURE FAILURE. PLEASE PAY ATTENTION TO YOUR SOLDERING PROCESS.		
3.2mm x 1.6mm PCB SURFACE MOUNT LED, 660nm SUPER RED LED, WATER CLEAR DOME LENS, TAPE AND REEL		DRAWN BY:	CHECKED BY:	APPROVED BY:
		BC		DATE: 1.12.01 PAGE: 1 OF 1 SCALE: N/A