

1 2 3 4 5 6

A

B

C

D

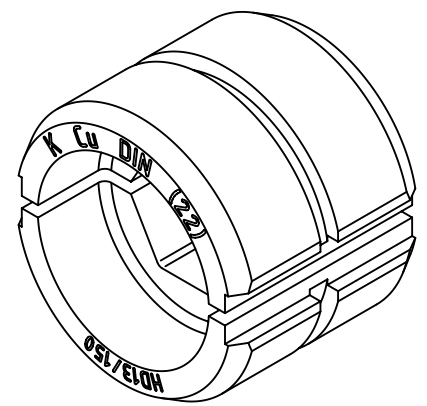
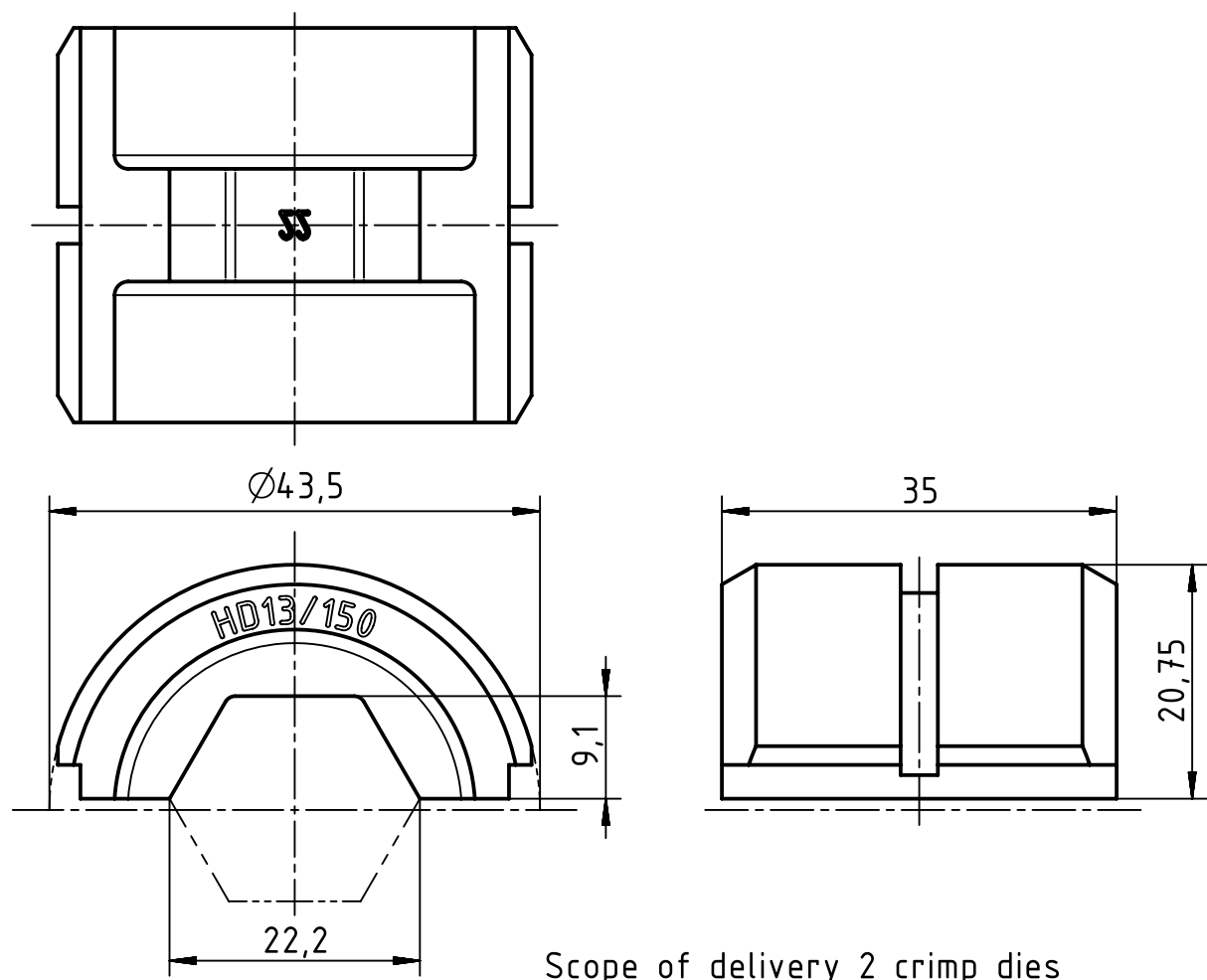

Scope of delivery 2 crimp dies

	All rights reserved Department EL PD - DE	All Dimensions in mm Original Size DIN A4		Scale 1.5:1	Free size tol.	Ref.	
		Created by HOLLERT	Inspected by RIEPE	Standardisation TIEMANNA	Date 2014-11-21	State Final Release	
HARTING Electric GmbH & Co. KG D-32339 Espelkamp		Title Crimp die 150mm <sup>2</sup> for 120 kN tool				Doc-Key / ECM-Nr. 100587244/UGD/002/B 500000081874	
		Type TB	Number 09 99 000 0870			Rev. B	Page 1/1

# Mouser Electronics

Authorized Distributor

Click to View Pricing, Inventory, Delivery & Lifecycle Information:

[HARTING:](#)

[09990000870](#)