

Micropower, Dual and Quad, Single Supply, Precision Op Amps

FEATURES

- Available in 8-Pin SO Package
- 50 μ A Max Supply Current per Amplifier
- 70 μ V Max Offset Voltage
- 180 μ V Max Offset Voltage in 8-Pin SO
- 250pA Max Offset Current
- 0.6 μ V_{P-P}, 0.1Hz to 10Hz Voltage Noise
- 3pA_{P-P}, 0.1Hz to 10Hz Current Noise
- 0.4 μ V/°C Offset Voltage Drift
- 200kHz Gain Bandwidth Product
- 0.07V/ μ s Slew Rate
- Single Supply Operation
 - Input Voltage Range Includes Ground
 - Output Swings to Ground while Sinking Current
 - No Pull-Down Resistors Needed
- Output Sources and Sinks 5mA Load Current

APPLICATIONS

- Battery or Solar-Powered Systems
 - Portable Instrumentation
 - Remote Sensor Amplifier
 - Satellite Circuitry
- Micropower Sample-and-Hold
- Thermocouple Amplifier
- Micropower Filters

DESCRIPTION

The LT[®]1078 is a micropower dual op amp in 8-pin packages including the small outline surface mount package. The LT1079 is a micropower quad op amp offered in the standard 14-pin packages. Both devices are optimized for single supply operation at 5V. \pm 15V specifications are also provided.

Micropower performance of competing devices is achieved at the expense of seriously degrading precision, noise, speed and output drive specifications. The design effort of the LT1078/LT1079 was concentrated on reducing supply current without sacrificing other parameters. The offset voltage achieved is the lowest on any dual or quad nonchopper stabilized op amp—micropower or otherwise. Offset current, voltage and current noise, slew rate and gain bandwidth product are all two to ten times better than on previous micropower op amps.

The 1/f corner of the voltage noise spectrum is at 0.7Hz, at least three times lower than on any monolithic op amp. This results in low frequency (0.1Hz to 10Hz) noise performance which can only be found on devices with an order of magnitude higher supply current.

Both the LT1078 and LT1079 can be operated from a single supply (as low as one lithium cell or two Ni-Cad batteries). The input range goes below ground. The all-NPN output stage swings to within a few millivolts of ground while sinking current—no power consuming pull down resistors are needed.

LT, LTC and LT are registered trademarks of Linear Technology Corporation.

TYPICAL APPLICATION

Single Battery, Micropower, Gain = 100, Instrumentation Amplifier

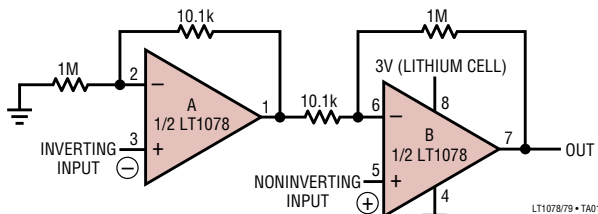

TYPICAL PERFORMANCE

INPUT OFFSET VOLTAGE = 40 μ V
 INPUT OFFSET CURRENT = 0.2nA
 TOTAL POWER DISSIPATION = 240 μ W
 COMMON MODE REJECTION = 110dB (AMPLIFIER LIMITED)
 GAIN BANDWIDTH PRODUCT = 200kHz

OUTPUT NOISE = 85 μ V_{P-P} 0.1Hz TO 10Hz
 = 300 μ V_{RMS} OVER FULL BANDWIDTH
 INPUT RANGE = 0.03V TO 1.8V
 OUTPUT RANGE = 0.03V TO 2.3V
 (0.3mV \leq V_{IN+} - V_{IN-} \leq 23mV)
 OUTPUTS SINK CURRENT—NO PULL-DOWN RESISTORS ARE NEEDED

Distribution of Input Offset Voltage (LT1078 and LT1079 in H, J, N Packages)

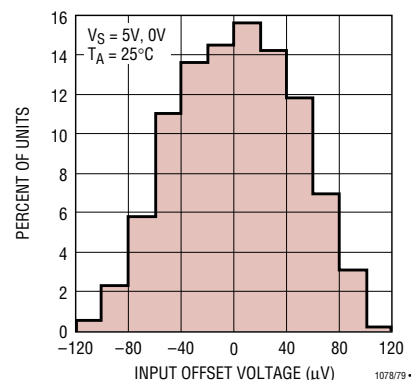

LT1078/LT1079

ABSOLUTE MAXIMUM RATINGS (Note 1)

Supply Voltage	$\pm 22\text{V}$	Operating Temperature Range	
Differential Input Voltage	$\pm 30\text{V}$	LT1078AM/LT1078M/	
Input Voltage	Equal to Positive Supply Voltage	LT1079AM/LT1079M (OBSELETE)	-55°C to 125°C
 5V Below Negative Supply Voltage	LT1078I/LT1079I	-40°C to 85°C
Output Short-Circuit Duration	Indefinite	LT1078AC/LT1078C/LT1078S8/	
Storage Temperature Range		LT1079AC/LT1079C	0°C to 70°C
All Grades	-65°C to 150°C	Lead Temperature (Soldering, 10 sec)	300°C

PACKAGE/ORDER INFORMATION

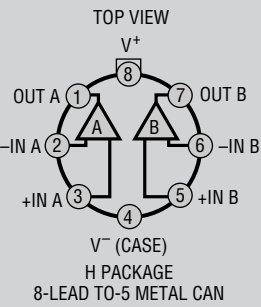
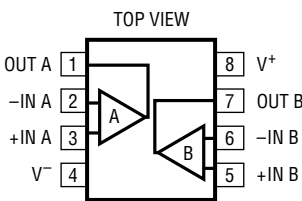
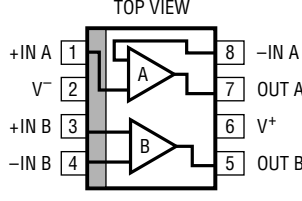
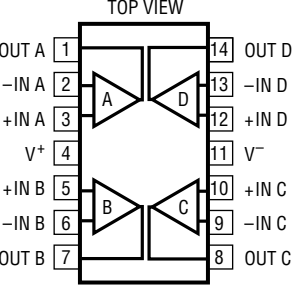
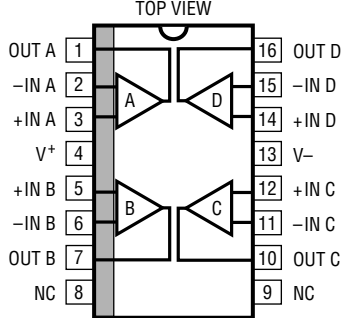
 <p>TOP VIEW</p> <p>OUT A 1, -IN A 2, +IN A 3, V- (CASE) 4, H PACKAGE, 8-LEAD TO-5 METAL CAN</p> <p>$T_{JMAX} = 150^{\circ}\text{C}$, $\theta_{JA} = 150^{\circ}\text{C/W}$, $\theta_{JC} = 45^{\circ}\text{C/W}$</p>	 <p>TOP VIEW</p> <p>OUT A 1, -IN A 2, +IN A 3, V- 4, N8 PACKAGE, 8-LEAD PDIP</p> <p>$T_{JMAX} = 100^{\circ}\text{C}$, $\theta_{JA} = 130^{\circ}\text{C/W}$ (N8)</p>	 <p>TOP VIEW</p> <p>+IN A 1, V- 2, +IN B 3, -IN B 4, S8 PACKAGE, 8-LEAD PLASTIC SO</p> <p>NOTE: THIS PIN CONFIGURATION DIFFERS FROM THE 8-LEAD DIP PIN LOCATIONS. INSTEAD, IT FOLLOWS THE INDUSTRY STANDARD LT1013DS8 SO PACKAGE CONFIGURATION. FOR SIMILAR PERFORMANCE WITH TRADITIONAL DIP PINOUT, SEE THE LT2078</p> <p>$T_{JMAX} = 110^{\circ}\text{C}$, $\theta_{JA} = 220^{\circ}\text{C/W}$</p>	
ORDER PART NUMBER	ORDER PART NUMBER		ORDER PART NUMBER
<p>LT1078ACH</p> <p>LT1078MH</p> <p>OBSELETE PACKAGES</p> <p>Consider the N8 and S8 Packages for Alternate Source</p>	<p>LT1078ACN8</p> <p>LT1078CN8</p> <p>LT1078IN8</p> <p>J8 PACKAGE</p> <p>8-LEAD PDIP</p> <p>$T_{JMAX} = 150^{\circ}\text{C}$, $\theta_{JA} = 100^{\circ}\text{C/W}$ (J8)</p> <p>LT1078AMJ8</p> <p>LT1078MJ8</p>		<p>LT1078IS8</p> <p>LT1078S8</p> <p>PART MARKING</p> <p>1078</p>
 <p>TOP VIEW</p> <p>OUT A 1, -IN A 2, +IN A 3, V+ 4, +IN B 5, -IN B 6, OUT B 7, N PACKAGE, 14-LEAD PDIP</p> <p>$T_{JMAX} = 110^{\circ}\text{C}$, $\theta_{JA} = 130^{\circ}\text{C/W}$ (N)</p>	ORDER PART NUMBER	 <p>TOP VIEW</p> <p>OUT A 1, -IN A 2, +IN A 3, V+ 4, +IN B 5, -IN B 6, OUT B 7, NC 8, SW PACKAGE, 16-LEAD PLASTIC SO WIDE</p> <p>NOTE: FOR 14-PIN NARROW PACKAGE SEE THE LT2079</p> <p>$T_{JMAX} = 110^{\circ}\text{C}$, $\theta_{JA} = 150^{\circ}\text{C/W}$</p>	ORDER PART NUMBER
<p>J PACKAGE</p> <p>14-LEAD CERAMIC DIP</p> <p>$T_{JMAX} = 150^{\circ}\text{C}$, $\theta_{JA} = 100^{\circ}\text{C/W}$ (J)</p> <p>OBSELETE PACKAGE</p> <p>Consider the N Packages for Alternate Source</p>	<p>LT1079ACN</p> <p>LT1079CN</p> <p>LT1079IN</p> <p>LT1079MJ</p>		<p>LT1079ISW</p> <p>LT1079SW</p>

10789fe

ELECTRICAL CHARACTERISTICS

$V_S = 5V, 0V, V_{CM} = 0.1V, V_O = 1.4V, T_A = 25^\circ C$ unless otherwise noted.

SYMBOL	PARAMETER	CONDITIONS (NOTE 2)	LT1078AC/LT1079AC LT1078AM/LT1079AM			LT1078C/LT1079C LT1078I/LT1079I LT1078M/LT1079M LT1078S8/LT1079SW			UNITS
			MIN	TYP	MAX	MIN	TYP	MAX	
V_{OS}	Input Offset Voltage	LT1078		30	70		40	120	μV
		LT1078IS8/LT1078S8					60	180	μV
		LT1079		35	100		40	150	μV
		LT1079ISW/LT1079SW					60	300	μV
$\frac{\Delta V_{OS}}{\Delta Time}$	Long Term Input Offset Voltage Stability			0.4			0.5	$\mu V/Mo$	
I_{OS}	Input Offset Current			0.05	0.25		0.05	0.35	nA
I_B	Input Bias Current			6	8		6	10	nA
e_n	Input Noise Voltage	0.1Hz to 10Hz (Note 3)		0.6	1.2		0.6		μV_{P-P}
	Input Noise Voltage Density	$f_0 = 10Hz$ (Note 3) $f_0 = 1000Hz$ (Note 3)		29	45		29		nV/\sqrt{Hz} nV/\sqrt{Hz}
i_n	Input Noise Current	0.1Hz to 10Hz (Note 3)		2.3	4.0		2.3		pA_{P-P}
	Input Noise Current Density	$f_0 = 10Hz$ (Note 3) $f_0 = 1000Hz$		0.06	0.10		0.06		pA/\sqrt{Hz} pA/\sqrt{Hz}
	Input Resistance Differential Mode Common Mode	(Note 4)	400	800	6	300	800	6	$M\Omega$ $G\Omega$
	Input Voltage Range		3.5	3.8	0	3.5	3.8	0	V V
CMRR	Common Mode Rejection Ratio	$V_{CM} = 0V$ to 3.5V		97	110		94	108	dB
PSRR	Power Supply Rejection Ratio	$V_S = 2.3V$ to 12V		102	114		100	114	dB
A_{VOL}	Large-Signal Voltage Gain	$V_O = 0.03V$ to 4V, No Load $V_O = 0.03V$ to 3.5V, $R_L = 50k$	200	1000	600	150	1000	600	V/mV V/mV
	Maximum Output Voltage Swing	Output Low, No Load Output Low, 2k to GND Output Low, $I_{SINK} = 100\mu A$		3.5	6		3.5	6	mV mV mV
		Output High, No Load Output High, 2k to GND	4.2	4.4	3.9	4.2	4.4	3.9	V V
SR	Slew Rate	$A_V = 1, V_S = \pm 2.5V$		0.04	0.07		0.04	0.07	V/ μs
GBW	Gain Bandwidth Product	$f_0 \leq 20kHz$		200			200		kHz
I_S	Supply Current per Amplifier			38	50		39	55	μA
	Channel Separation	$\Delta V_{IN} = 3V, R_L = 10k$		130			130		dB
	Minimum Supply Voltage	(Note 5)		2.2	2.3		2.2	2.3	V

LT1078/LT1079

ELECTRICAL CHARACTERISTICS The ● denotes the specifications which apply over the temperature range $-40^{\circ}\text{C} \leq T_A \leq 85^{\circ}\text{C}$ for I grades, $-55^{\circ}\text{C} \leq T_A \leq 125^{\circ}\text{C}$ for AM/M grades. $V_S = 5\text{V}$, 0V , $V_{\text{CM}} = 0.1\text{V}$, $V_O = 1.4\text{V}$ unless otherwise noted.

SYMBOL	PARAMETER	CONDITIONS		LT1078AM/LT1079AM			LT1078I/LT1079I LT1078M/LT1079M			UNITS
				MIN	TYP	MAX	MIN	TYP	MAX	
V_{OS}	Input Offset Voltage	LT1078	●		70	250		95	370	μV
		LT1078IS8/LT1079	●		80	280		100	400	μV
		LT1079ISW	●					100	560	μV
$\frac{\Delta V_{\text{OS}}}{\Delta T}$	Input Offset Voltage Drift (Note 6)	LT1078IS8	●		0.4	1.8		0.5	2.5	$\mu\text{V}/^{\circ}\text{C}$
		LT1079ISW	●					0.6	3.5	$\mu\text{V}/^{\circ}\text{C}$
			●					0.7	4.0	$\mu\text{V}/^{\circ}\text{C}$
I_{OS}	Input Offset Current	LT1078I/LT1079I	●		0.07	0.50		0.07	0.70	nA
			●					0.1	1.0	nA
I_B	Input Bias Current		●		7	10		7	12	nA
CMRR	Common Mode Rejection Ratio	$V_{\text{CM}} = 0.05\text{V}$ to 3.2V	●	92	106		88	104		dB
PSRR	Power Supply Rejection Ratio	$V_S = 3.1\text{V}$ to 12V	●	98	110		94	110		dB
A_{VOL}	Large-Signal Voltage Gain	$V_O = 0.05\text{V}$ to 4V , No Load	●	110	600		80	600		V/mV
		$V_O = 0.05\text{V}$ to 3.5V , $R_L = 50\text{k}$	●	80	400		60	400		V/mV
	Maximum Output Voltage Swing	Output Low, No Load	●		4.5	8		4.5	8	mV
		Output Low, $I_{\text{SINK}} = 100\mu\text{A}$	●		125	170		125	170	mV
		Output High, No Load	●	3.9	4.2		3.9	4.2		V
		Output High, 2k to GND	●	3.0	3.7		3.0	3.7		V
I_S	Supply Current per Amplifier		●		43	60		45	70	μA

The ● denotes the specifications which apply over the temperature range $0^{\circ}\text{C} \leq T_A \leq 70^{\circ}\text{C}$. $V_S = 5\text{V}$, 0V , $V_{\text{CM}} = 0.1\text{V}$, $V_O = 1.4\text{V}$ unless otherwise noted.

SYMBOL	PARAMETER	CONDITIONS		LT1078AC/LT1079AC			LT1078C/LT1079C LT1078S8/LT1079SW			UNITS
				MIN	TYP	MAX	MIN	TYP	MAX	
V_{OS}	Input Offset Voltage	LT1078	●		50	150		60	240	μV
		LT1079	●		60	180		70	270	μV
		LT1078S8	●					85	350	μV
		LT1079SW	●					90	480	μV
$\frac{\Delta V_{\text{OS}}}{\Delta T}$	Input Offset Voltage Drift (Note 6)	LT1078S8	●		0.4	1.8		0.5	2.5	$\mu\text{V}/^{\circ}\text{C}$
		LT1079SW	●					0.6	3.5	$\mu\text{V}/^{\circ}\text{C}$
			●					0.7	4.0	$\mu\text{V}/^{\circ}\text{C}$
I_{OS}	Input Offset Current		●		0.06	0.35		0.06	0.50	nA
I_B	Input Bias Current		●		6	9		6	11	nA
CMRR	Common Mode Rejection Ratio	$V_{\text{CM}} = 0\text{V}$ to 3.4V	●	94	108		90	106		dB
PSRR	Power Supply Rejection Ratio	$V_S = 2.6\text{V}$ to 12V	●	100	112		97	112		dB
A_{VOL}	Large-Signal Voltage Gain	$V_O = 0.05\text{V}$ to 4V , No Load	●	150	750		110	750		V/mV
		$V_O = 0.05\text{V}$ to 3.5V , $R_L = 50\text{k}$	●	110	500		80	500		V/mV
	Maximum Output Voltage Swing	Output Low, No Load	●		4.0	7		4.0	7	mV
		Output Low, $I_{\text{SINK}} = 100\mu\text{A}$	●		105	150		105	150	mV
		Output High, No Load	●	4.1	4.3		4.1	4.3		V
		Output High, 2k to GND	●	3.3	3.8		3.3	3.8		V
I_S	Supply Current per Amplifier		●		40	55		42	63	μA

ELECTRICAL CHARACTERISTICS

$V_S = \pm 15V$, $T_A = 25^\circ C$ unless otherwise noted.

SYMBOL	PARAMETER	CONDITIONS	LT1078AC/LT1079AC LT1078AM/LT1079AM			LT1078C/LT1079C LT1078I/LT1079I LT1078M/LT1079M LT1078S8/LT1079SW			UNITS
			MIN	TYP	MAX	MIN	TYP	MAX	
V_{OS}	Input Offset Voltage	(Including LT1078IS8/LT1078S8) LT1079ISW/LT1079SW		50	250	70	350	μV μV	
I_{OS}	Input Offset Current			0.05	0.25	0.05	0.35	nA	
I_B	Input Bias Current			6	8	6	10	nA	
	Input Voltage Range		13.5 -15.0	13.8 -15.3		13.5 -15.0	13.8 -15.3	V V	
CMRR	Common Mode Rejection Ratio	$V_{CM} = 13.5V, -15V$	100	114		97	114	dB	
PSRR	Power Supply Rejection Ratio	$V_S = 5V, 0V$ to $\pm 18V$	102	114		100	114	dB	
A_{VOL}	Large-Signal Voltage Gain	$V_O = \pm 10V, R_L = 50k$ $V_O = \pm 10V, R_L = 2k$	1000 400	5000 1100		1000 300	5000 1100	V/mV V/mV	
V_{OUT}	Maximum Output Voltage Swing	$R_L = 50k$ $R_L = 2k$	± 13.0 ± 11.0	± 14.0 ± 13.2		± 13.0 ± 11.0	± 14.0 ± 13.2	V V	
SR	Slew Rate		0.06	0.10		0.06	0.10	V/ μs	
I_S	Supply Current per Amplifier			46	65		47	75	μA

The ● denotes the specifications which apply over the temperature range $-40^\circ C \leq T_A \leq 85^\circ C$ for I grades, $-55^\circ C \leq T_A \leq 125^\circ C$ for AM/M grades. $V_S = \pm 15V$ unless otherwise noted.

SYMBOL	PARAMETER	CONDITIONS	LT1078AM/LT1079AM			LT1078I/LT1079I LT1078M/LT1079M			UNITS
			MIN	TYP	MAX	MIN	TYP	MAX	
V_{OS}	Input Offset Voltage	(Including LT1078IS8) LT1079ISW		90	430	120	600	μV μV	
$\frac{\Delta V_{OS}}{\Delta T}$	Input Offset Voltage Drift (Note 6)	LT1078IS8 LT1079ISW		0.5	1.8	0.6	2.5	$\mu V/^\circ C$ $\mu V/^\circ C$ $\mu V/^\circ C$	
I_{OS}	Input Offset Current	LT1078I/LT1079I		0.07	0.50	0.07	0.70	nA nA	
I_B	Input Bias Current			7	10	7	12	nA	
A_{VOL}	Large-Signal Voltage Gain	$V_O = \pm 10V, R_L = 5k$		200	700	150	700	V/mV	
CMRR	Common Mode Rejection Ratio	$V_{CM} = 13V, -14.9V$		94	110	90	110	dB	
PSRR	Power Supply Rejection Ratio	$V_S = 5V, 0V$ to $\pm 18V$		98	110	94	110	dB	
	Maximum Output Voltage Swing	$R_L = 5k$		± 11.0	± 13.5	± 11.0	± 13.5	V	
I_S	Supply Current per Amplifier			52	80	54	95	μA	

LT1078/LT1079

ELECTRICAL CHARACTERISTICS

The ● denotes the specifications which apply over the temperature range

$0^{\circ}\text{C} \leq T_A \leq 70^{\circ}\text{C}$. $V_S = \pm 15\text{V}$ unless otherwise noted.

SYMBOL	PARAMETER	CONDITIONS		LT1078AC/LT1079AC			LT1078C/LT1079C LT1078S8/LT1079SW			UNITS
				MIN	TYP	MAX	MIN	TYP	MAX	
V_{OS}	Input Offset Voltage	LT1078S8 LT1079SW	●	70	330	90	460	100	540	μV
			●							
			●							
$\frac{\Delta V_{OS}}{\Delta T}$	Input Offset Voltage Drift (Note 6)	LT1078S8 LT1079SW	●	0.5	1.8	0.6	2.5	0.7	3.8	$\mu\text{V}/^{\circ}\text{C}$
			●							
			●							
I_{OS}	Input Offset Current		●	0.06	0.35	0.06	0.50			nA
I_B	Input Bias Current		●	6	9	6	11			nA
A_{VOL}	Large-Signal Voltage Gain	$V_O = \pm 10\text{V}$, $R_L = 5\text{k}$	●	300	1200	250	1200			V/mV
CMRR	Common Mode Rejection Ratio	$V_{CM} = 13\text{V}$, -15V	●	97	112	94	112			dB
PSRR	Power Supply Rejection Ratio	$V_S = 5\text{V}$, 0V to $\pm 18\text{V}$	●	100	112	97	112			dB
	Maximum Output Voltage Swing	$R_L = 5\text{k}$	●	± 11.0	± 13.6	± 11.0	± 13.6			V
I_S	Supply Current per Amplifier		●	49	73	50	85			μA

Note 1: Absolute Maximum Ratings are those values beyond which the life of a device may be impaired.

Note 2: Typical parameters are defined as the 60% yield of parameter distributions of individual amplifiers, i.e., out of 100 LT1079s (or 100 LT1078s) typically 240 op amps (or 120) will be better than the indicated specification.

Note 3: This parameter is tested on a sample basis only. All noise parameters are tested with $V_S = \pm 2.5\text{V}$, $V_O = 0\text{V}$.

Note 4: This parameter is guaranteed by design and is not tested.

Note 5: Power supply rejection ratio is measured at the minimum supply voltage. The op amps actually work at 1.8V supply but with a typical offset skew of $-300\mu\text{V}$.

Note 6: This parameter is not 100% tested.

TYPICAL PERFORMANCE CHARACTERISTICS

Supply Current vs Temperature

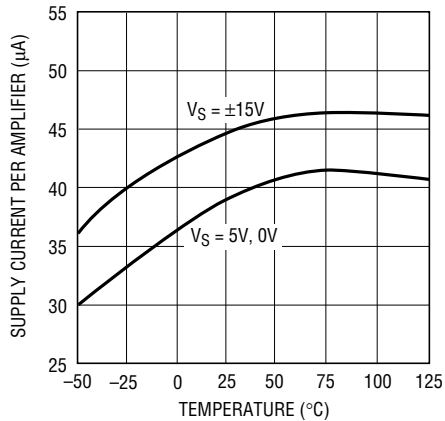

LT1078/79 • TPC01

Input Bias and Offset Currents vs Temperature

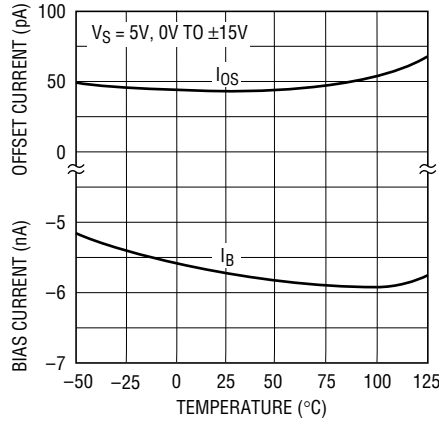

LT1078/79 • TPC02

Input Bias Current vs Common Mode Voltage

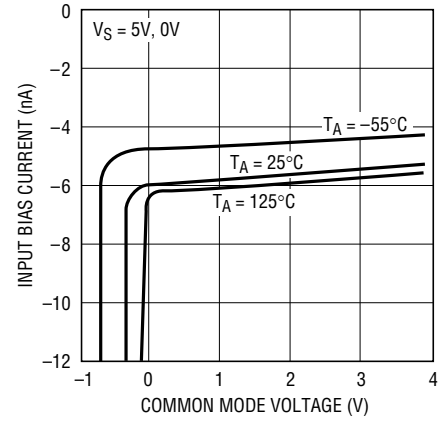

LT1078/79 • TPC03

0.1Hz to 10Hz Noise

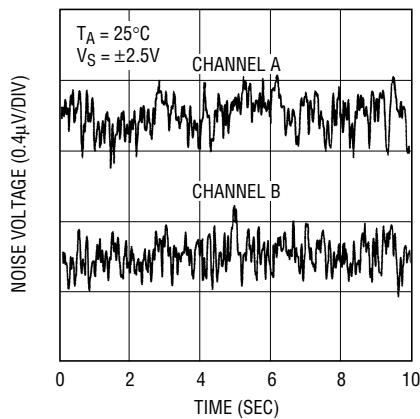

LT1078/79 • TPC04

0.01Hz to 10Hz Noise

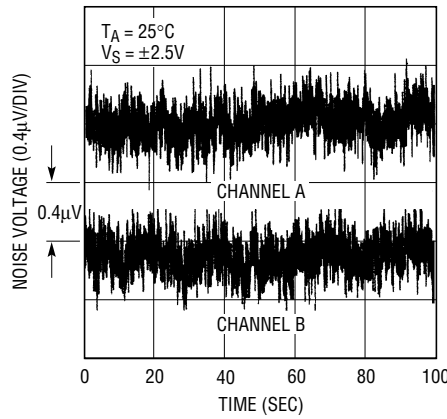

LT1078/79 • TPC05

Noise Spectrum

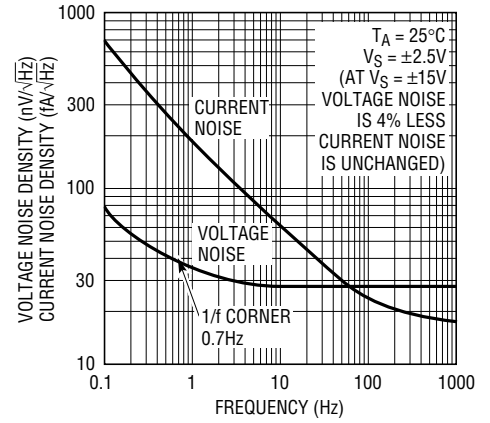

LT1078/79 • TPC06

10Hz Voltage Noise Distribution

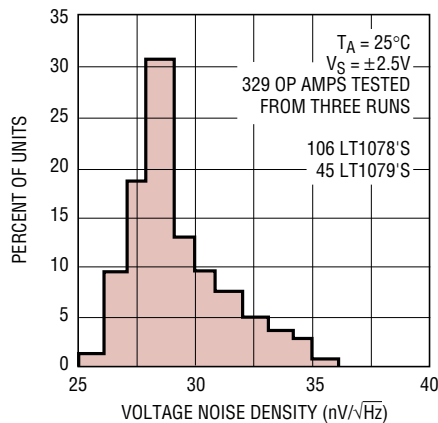

LT1078/79 • TPC07

Distribution of Offset Voltage Drift with Temperature (In All Packages Except Surface Mount)

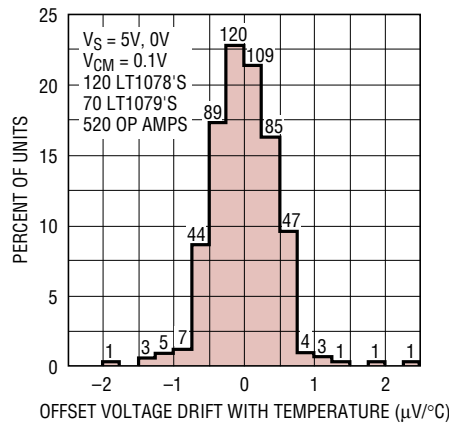

LT1078/79 • TPC08

Long Term Stability of Two Representative Units (LT1078)

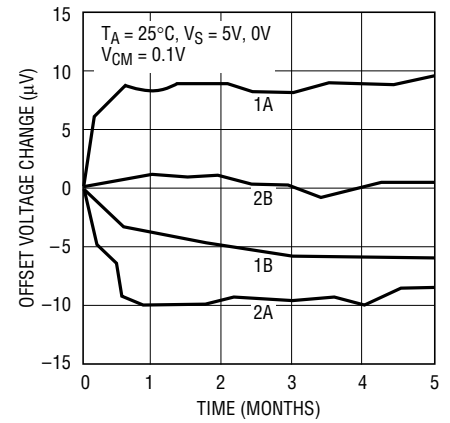

LT1078/79 • TPC09

TYPICAL PERFORMANCE CHARACTERISTICS

Voltage Gain vs Frequency

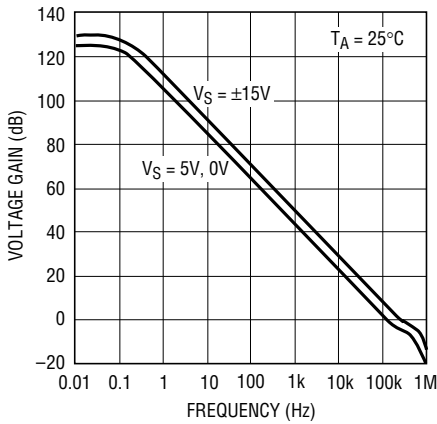

LT1078/79 • TPC10

Gain, Phase vs Frequency

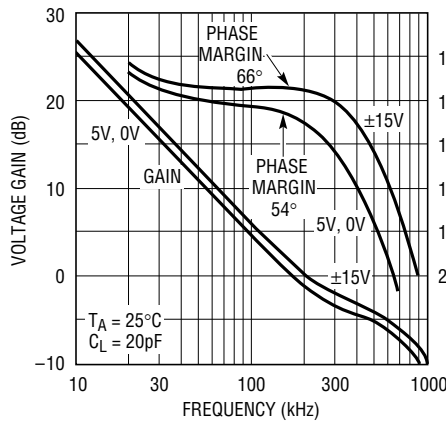

LTC1078/79 TPC11

Capacitive Load Handling

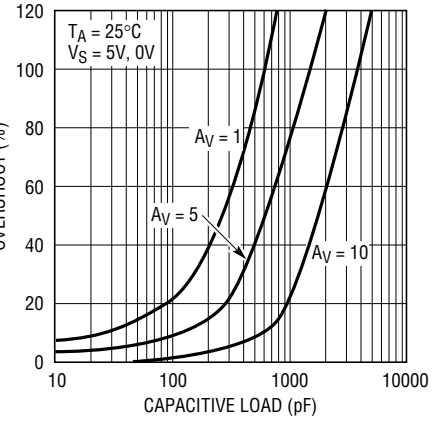

LT1078/79 • TPC12

Slew Rate, Gain Bandwidth Product and Phase Margin vs Temperature

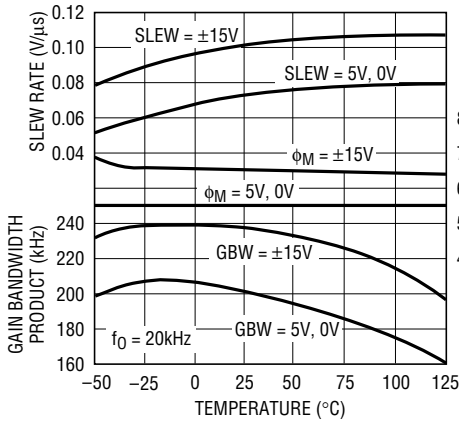

LT1078/79 • TPC13

Large-Signal Transient Response V_S = 5V, 0V

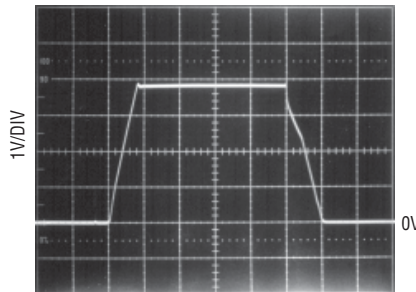

A_V = 1, NO LOAD 50μs/DIV INPUT PULSE 0V TO 3.8V

LT1078/79 • TPC27

Large-Signal Transient Response V_S = ±15V

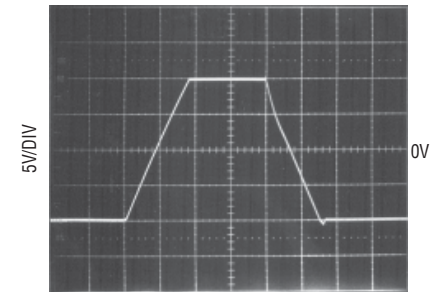

A_V = 1 NO LOAD 100μs/DIV

LT1078/79 • TPC28

Minimum Supply Voltage

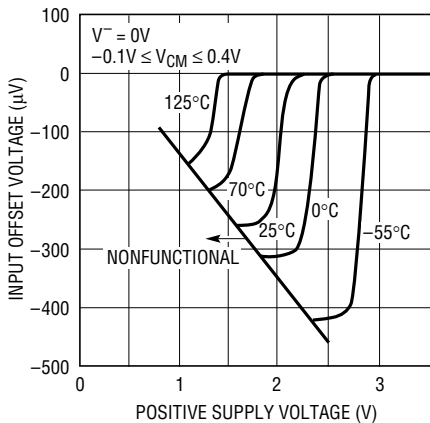

LT1078/79 • TPC16

Warm-Up Drift

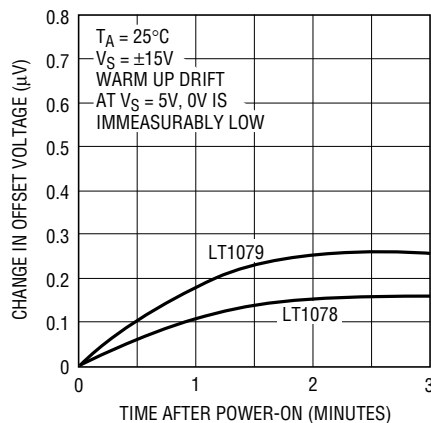

LT1078/79 • TPC17

Voltage Gain vs Load Resistance

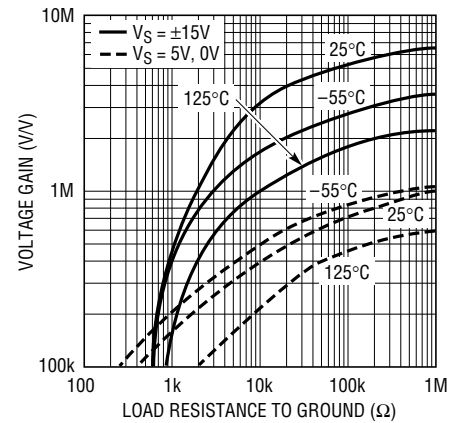

LT1078/79 • TPC18

TYPICAL PERFORMANCE CHARACTERISTICS

Output Saturation vs Temperature vs Sink Current

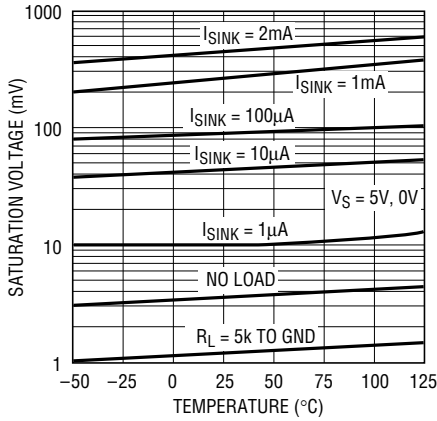

LT1078/79 • TPC19

Output Voltage Swing vs Load Current

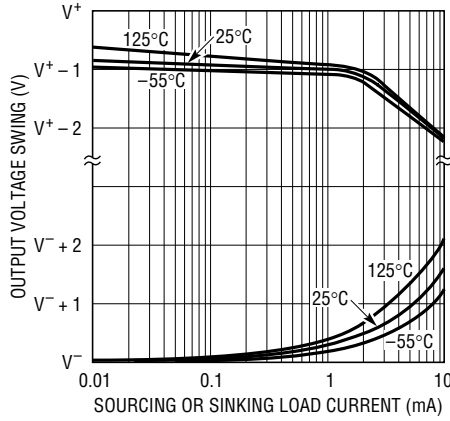

LT1078/79 • TPC20

Distribution of Input Offset Voltage (LT1078 in 8-Pin SO Package)

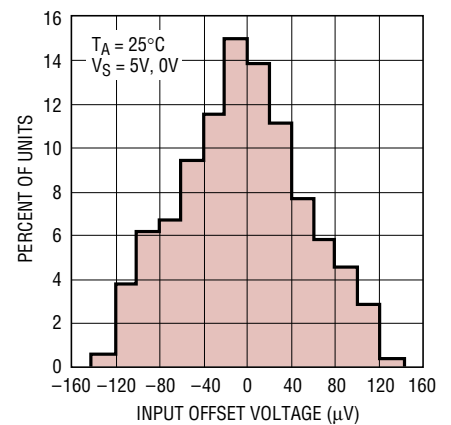

LT1078/79 • TPC21

Common Mode Range vs Temperature

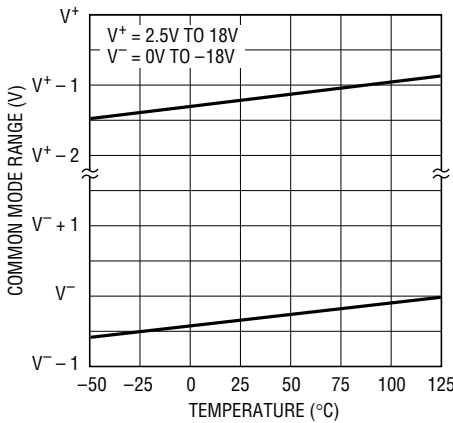

LT1078/79 • TPC22

Undistorted Output Swing vs Frequency

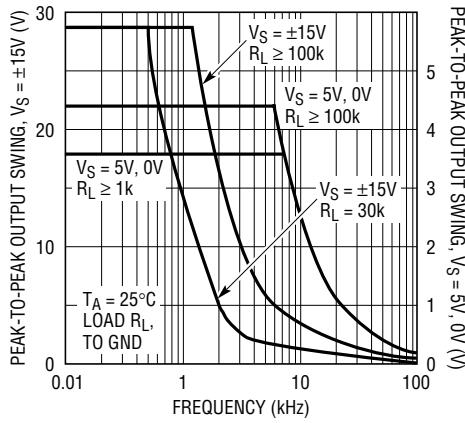

LT1078/79 • TPC23

Closed Loop Output Impedance

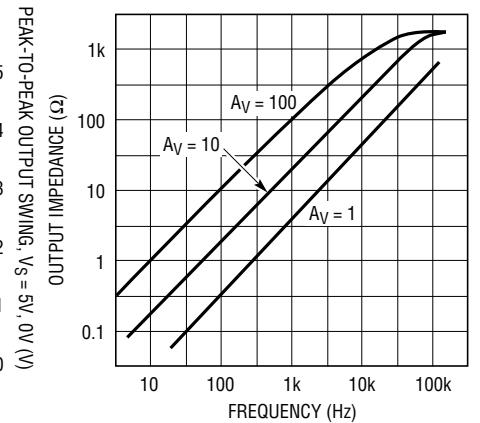

LT1078/79 • TPC24

Common Mode Rejection Ratio vs Frequency

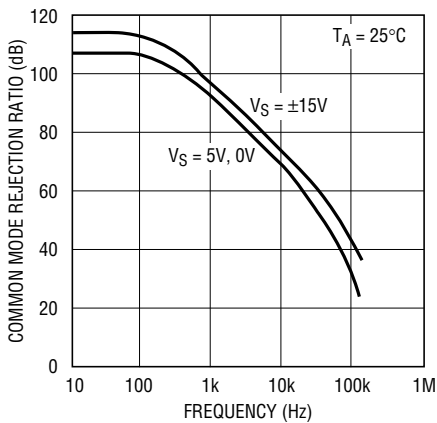

LT1078/79 • TPC25

Power Supply Rejection Ratio vs Frequency

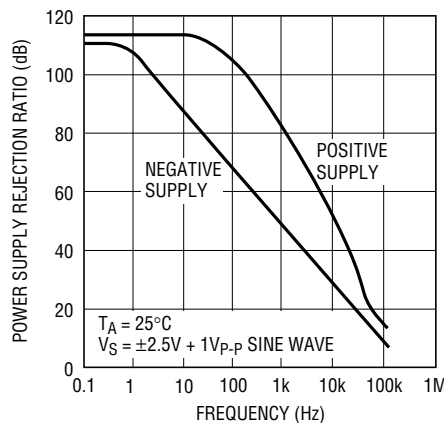

LT1078/79 • TPC26

Channel Separation vs Frequency

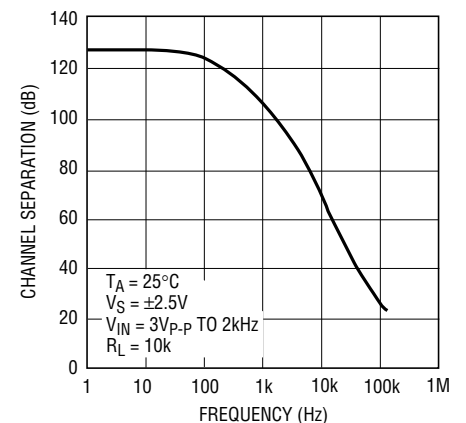

LT1078/79 • TPC27

TYPICAL PERFORMANCE CHARACTERISTICS

Small-Signal Transient Response
 $V_S = 5V, 0V$

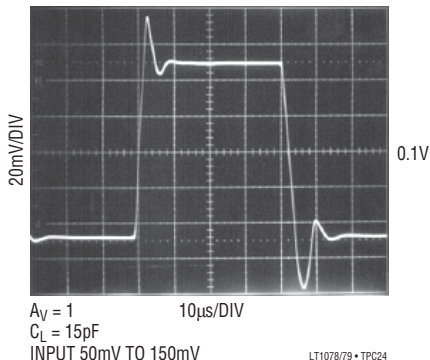

Small-Signal Transient Response
 $V_S = \pm 2.5V$

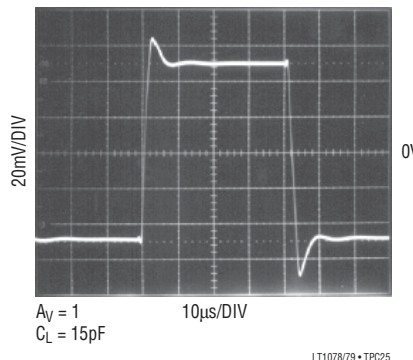

Small-Signal Transient Response
 $V_S = \pm 15V$

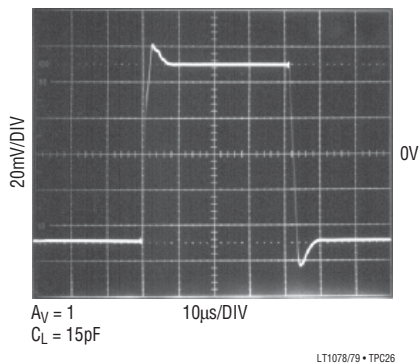

APPLICATIONS INFORMATION

The LT1078/LT1079 devices are fully specified with $V^+ = 5V$, $V^- = 0V$, $V_{CM} = 0.1V$. This set of operating conditions appears to be the most representative for battery-powered micropower circuits. Offset voltage is internally trimmed to a minimum value at these supply voltages. When 9V or 3V batteries or $\pm 2.5V$ dual supplies are used, bias and offset current changes will be minimal. Offset voltage changes will be just a few microvolts as given by the PSRR and CMRR specifications. For example, if $PSRR = 114dB (= 2\mu V/V)$, at 9V the offset voltage change will be $8\mu V$. Similarly, $V_S = \pm 2.5V$, $V_{CM} = 0V$ is equivalent to a common mode voltage change of 2.4V or a V_{OS} change of $7\mu V$ if $CMRR = 110dB (3\mu V/V)$.

A full set of specifications is also provided at $\pm 15V$ supply voltages for comparison with other devices and for completeness.

Single Supply Operation

The LT1078/LT1079 are fully specified for single supply operation, i.e., when the negative supply is 0V. Input common mode range goes below ground and the output swings within a few millivolts of ground while sinking current. All competing micropower op amps either cannot swing to within 600mV of ground (OP-20, OP-220, OP-420) or need a pull-down resistor connected to the output to swing to ground (OP-90, OP-290, OP-490, HA5141/42/44). This

APPLICATIONS INFORMATION

difference is critical because in many applications these competing devices cannot be operated as micropower op amps and swing to ground simultaneously.

As an example, consider the instrumentation amplifier shown on the front page. When the common mode signal is low and the output is high, amplifier A has to sink current. When the common mode signal is high and the output low, amplifier B has to sink current. The competing devices require a 12k pull-down resistor at the output of amplifier A and a 15k at the output of B to handle the specified signals. (The LT1078 does not need pull-down resistors.) When the common mode input is high and the output is high these pull-down resistors draw 300 μ A (150 μ A each), which is excessive for micropower applications.

The instrumentation amplifier is by no means the only application requiring current sinking capability. In seven of the nine single supply applications shown in this data sheet the op amps have to be able to sink current. In two of the applications the first amplifier has to sink only the 6nA input bias current of the second op amp. The competing devices, however, cannot even sink 6nA without a pull-down resistor

Since the output of the LT1078/LT1079 cannot go exactly to ground, but can only approach ground to within a few millivolts, care should be exercised to ensure that the output is not saturated. For example, a 1mV input signal will cause the amplifier to set up in its linear region in the gain 100 configuration shown in Figure 1a, but is not

enough to make the amplifier function properly in the voltage follower mode, Figure 1b.

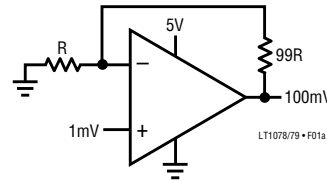

Figure 1a. Gain 100 Amplifier

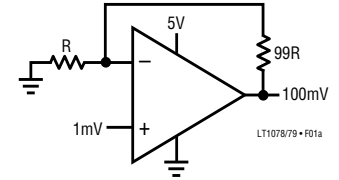
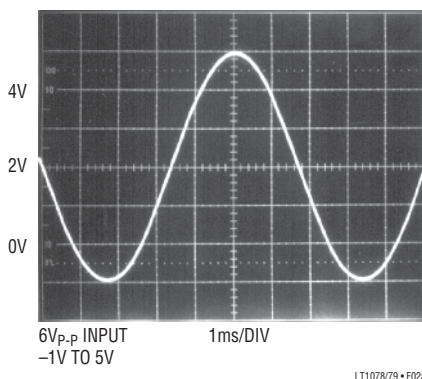

Figure 1b. Voltage Follower

Single supply operation can also create difficulties at the input. The driving signal can fall below 0V — inadvertently or on a transient basis. If the input is more than a few hundred millivolts below ground, two distinct problems can occur on previous single supply designs, such as the LM124, LM158, OP-20, OP-21, OP-220, OP-221, OP-420 (1 and 2), OP-90/290/490 (2 only):

1. When the input is more than a diode drop below ground, unlimited current will flow from the substrate (V^- terminal) to the input. This can destroy the unit. On the LT1078/LT1079, resistors in series with the input protect the devices even when the input is 5V below ground.
2. When the input is more than 400mV below ground (at 25°C), the input stage saturates and phase reversal occurs at the output. This can cause lockup in servo systems. Due to a unique phase reversal protection circuitry, the LT1078/LT1079 output does not reverse, as illustrated in Figure 2, even when the inputs are at $-1V$.



LT1078/79 • F02a

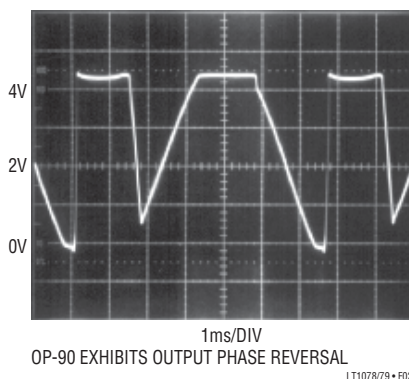

LT1078/79 • F02b

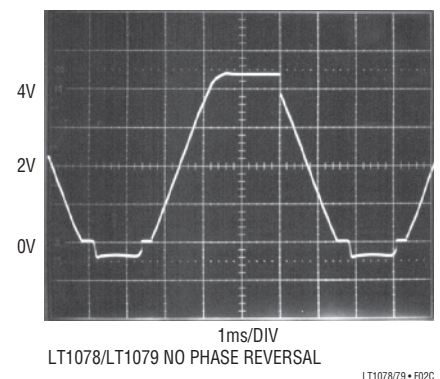

LT1078/79 • F02c

Figure 2. Voltage Follower with Input Exceeding the Negative Common Mode Range ($V_S = 5V, 0V$)

APPLICATIONS INFORMATION

Matching Specifications

In many applications the performance of a system depends on the matching between two op amps, rather than the individual characteristics of the two devices. The two and three op amp instrumentation amplifier configurations shown in this data sheet are examples. Matching characteristics are not 100% tested on the LT1078/LT1079.

Some specifications are guaranteed by definition. For example, 70 μ V maximum offset voltage implies that mismatch cannot be more than 140 μ V. 97dB (= 14 μ V/V) CMRR means that worst-case CMRR match is 91dB (= 28 μ V/V). However, Table 1 can be used to estimate the expected matching performance at $V_S = 5V, 0V$ between the two sides of the LT1078, and between amplifiers A and D, and between amplifiers B and C of the LT1079.

Table 1

PARAMETER		LT1078AC/LT1079AC/LT1078AM/LT1079AM		LT1078C/LT1079C/LT1078M/LT1079M		UNITS
		50% YIELD	98% YIELD	50% YIELD	98% YIELD	
V_{OS} Match, ΔV_{OS}	LT1078	30	110	50	190	μ V
	LT1079	40	150	50	250	μ V
Temperature Coefficient ΔV_{OS}		0.5	1.2	0.6	1.8	μ V/ $^{\circ}$ C
Average Noninverting I_B		6	8	6	10	nA
Match of Noninverting I_B		0.12	0.4	0.15	0.5	nA
CMRR Match		120	100	117	97	dB
PSRR Match		117	105	117	102	dB

Comparator Applications

The single supply operation of the LT1078/LT1079 and its ability to swing close to ground while sinking current

lends itself to use as a precision comparator with TTL compatible output.

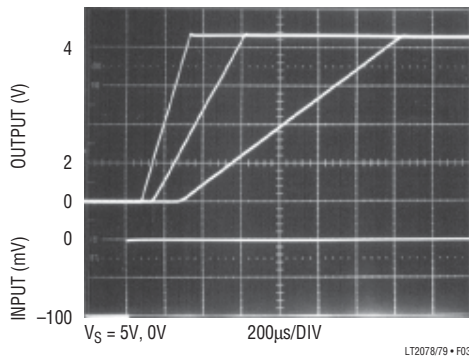

Figure 3. Comparator Rise Response Time to 10mV, 5mV, 2mV Overdrives

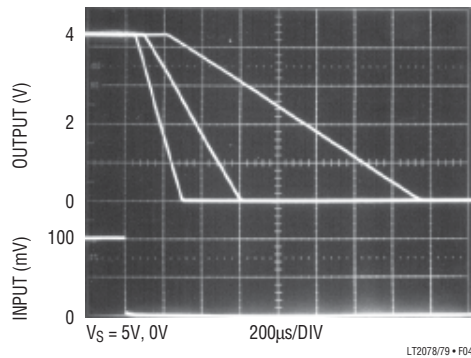
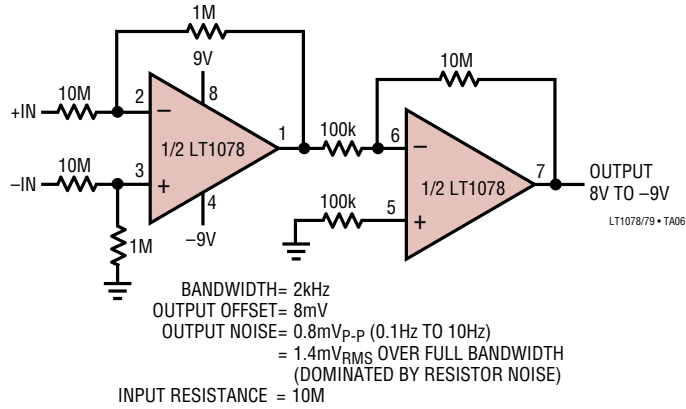

Figure 4. Comparator Fall Response Time to 10mV, 5mV, 2mV Overdrives

TYPICAL APPLICATIONS

85V, -100V Common Mode Range Instrumentation Amplifier ($A_V = 10$)



Half-Wave Rectifier

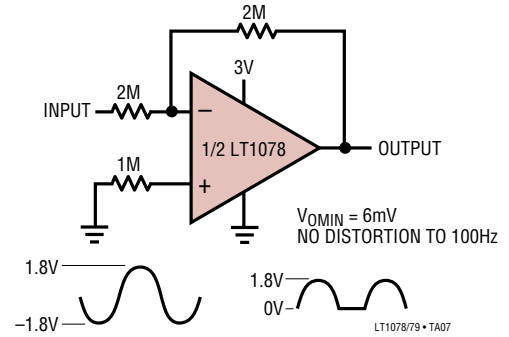

Absolute Value Circuit (Full-Wave Rectifier)

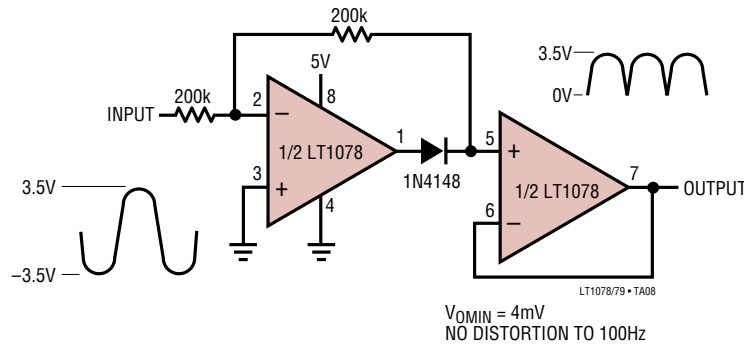

Programmable Gain Amplifier (Single Supply)

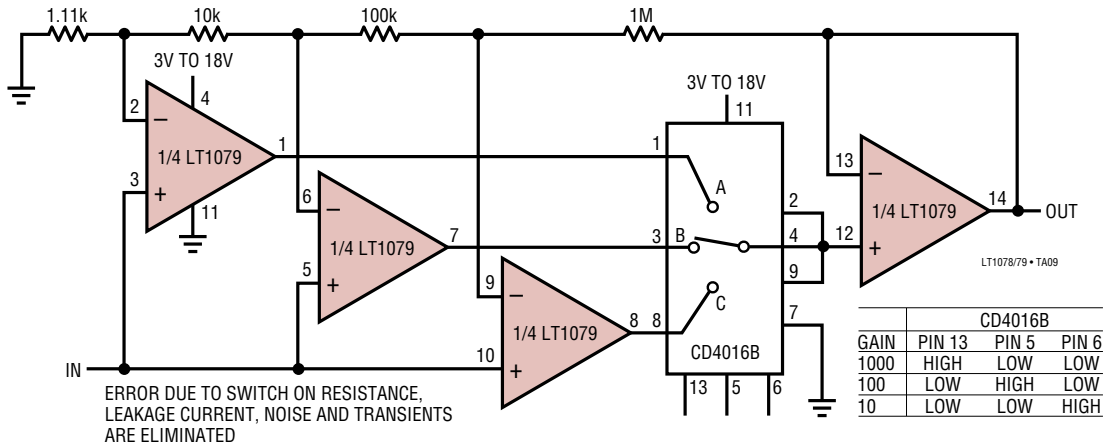

TYPICAL APPLICATIONS

Single Supply, Micropower, Second Order Lowpass Filter with 60Hz Notch

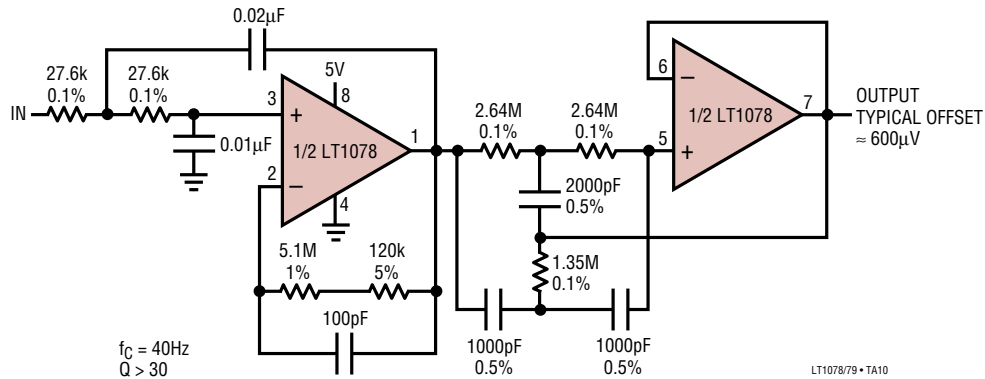

Micropower Multiplier/Divider

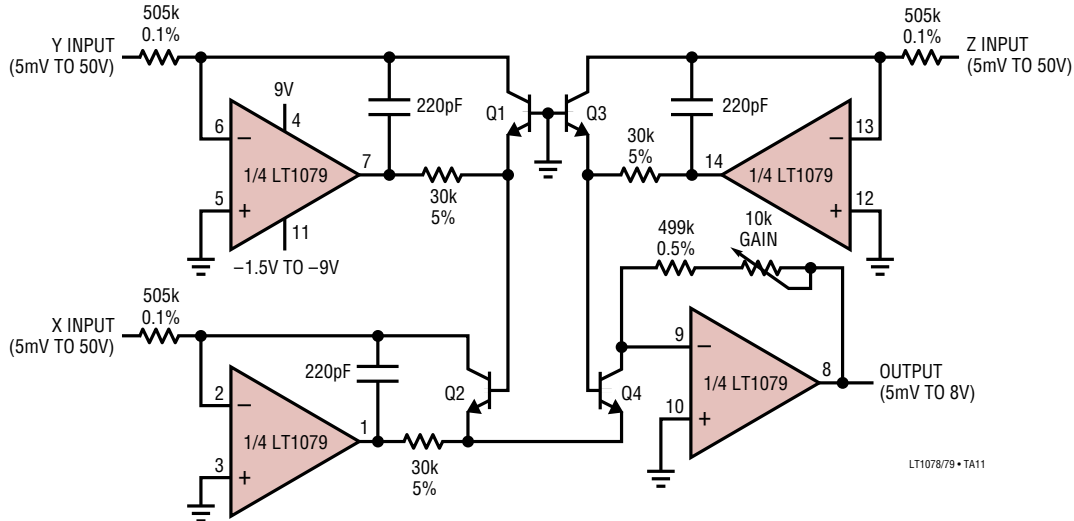

Q1, Q2, Q3, Q4 = MAT-04

TYPICAL LINEARITY = 0.01% OF FULL-SCALE OUTPUT

$$\text{OUTPUT} = \frac{(X)(Y)}{(Z)}, \text{ POSITIVE INPUTS ONLY}$$

$$\text{NEGATIVE SUPPLY CURRENT} = 165\mu\text{A} + \frac{X + Y + Z + \text{OUT}}{500\text{k}}$$

$$\text{POSITIVE SUPPLY CURRENT} = 165\mu\text{A} + \frac{\text{OUT}}{500\text{k}}$$

BANDWIDTH (< 3V_{p-p} SIGNAL): X AND Y INPUTS = 10kHz
Z INPUT = 4kHz

TYPICAL APPLICATIONS

Lead-Acid Low-Battery Detector with System Shutdown

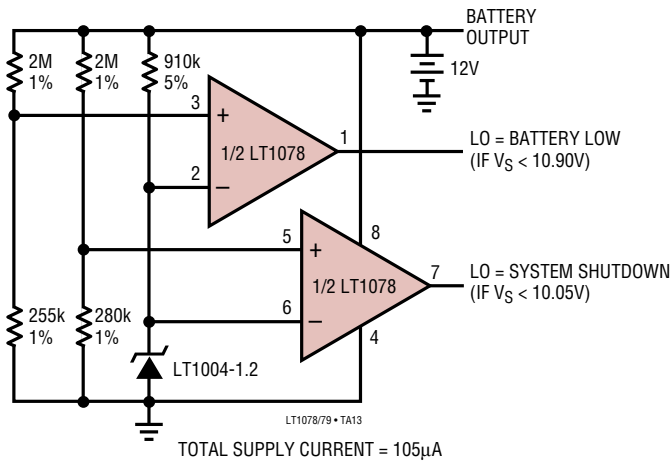

Platinum RTD Signal Conditioner with Curvature Correction

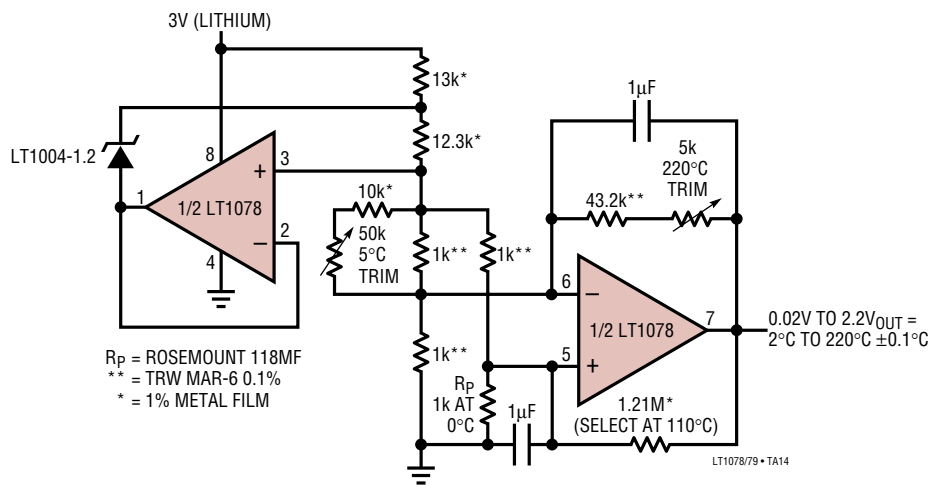

SIMPLIFIED SCHEMATIC

1/2 LT1078, 1/4 LT1079

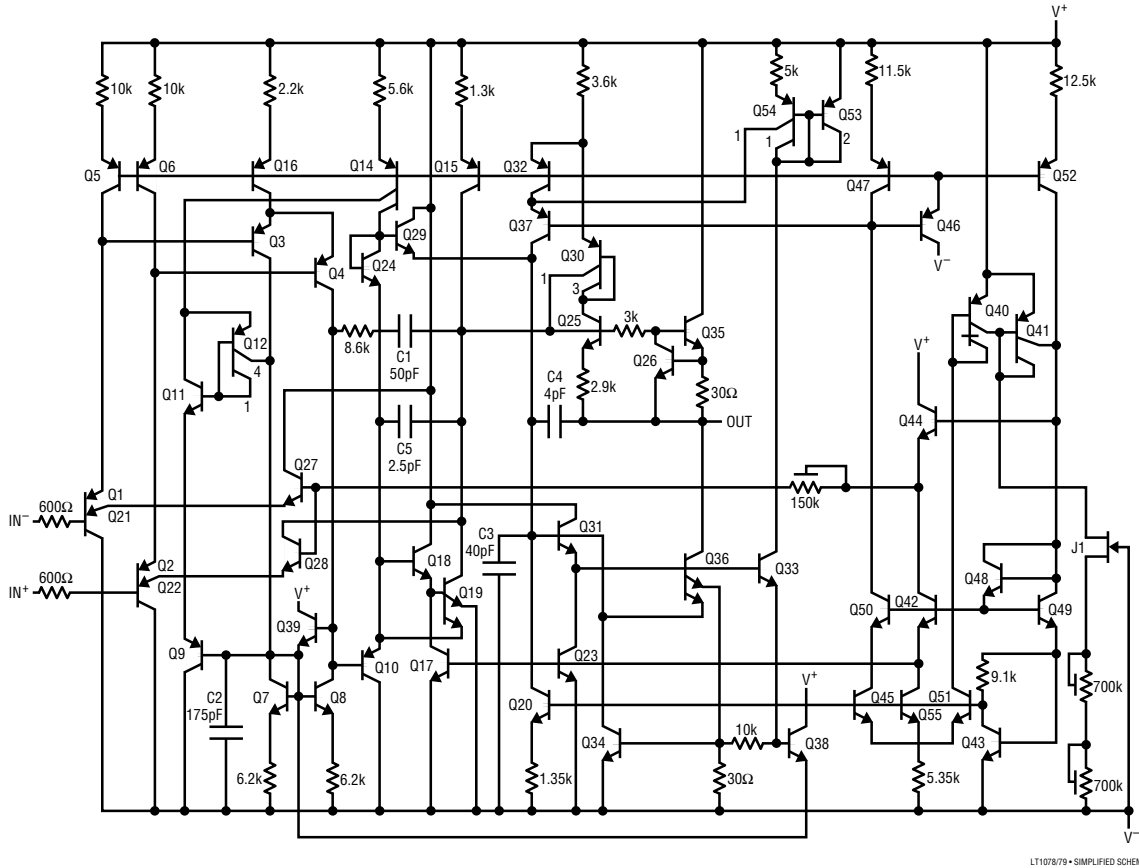

LT1078/79 • SIMPLIFIED SCHEM

PACKAGE DESCRIPTION

H Package
8-Lead TO-5 Metal Can (.230 Inch PCD)
 (Reference LTC DWG # 05-08-1321)

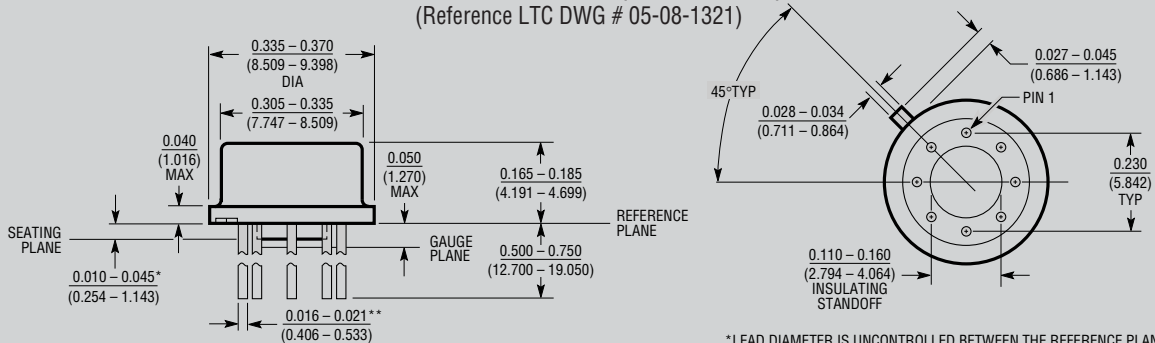

* LEAD DIAMETER IS UNCONTROLLED BETWEEN THE REFERENCE PLANE AND 0.045" BELOW THE REFERENCE PLANE
 ** FOR SOLDER DIP LEAD FINISH, LEAD DIAMETER IS 0.016 - 0.024 (0.406 - 0.610)

H8 (TO-5) 0.230 PCD 1197

OBSOLETE PACKAGE

PACKAGE DESCRIPTION

J8 Package 8-Lead CERDIP (Narrow .300 Inch, Hermetic) (Reference LTC DWG # 05-08-1110)

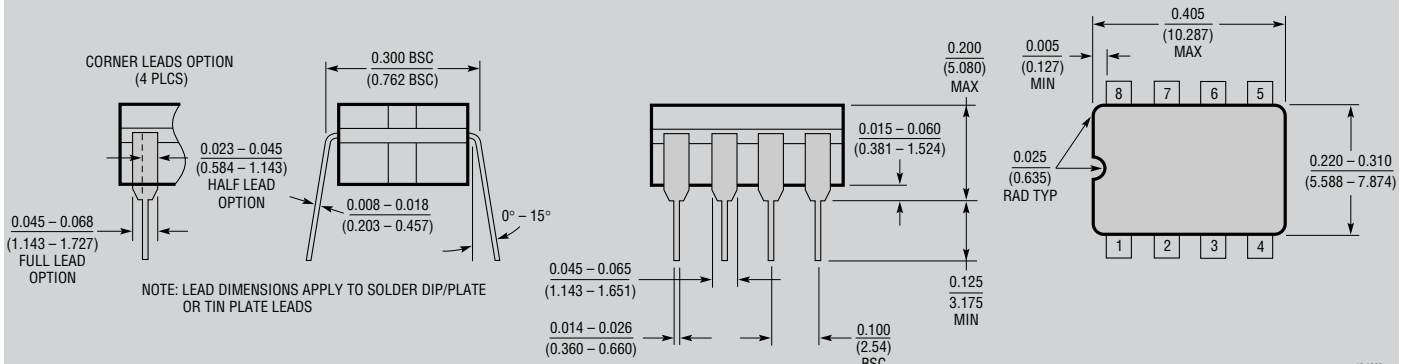

J Package 14-Lead CERDIP (Narrow .300 Inch, Hermetic) (Reference LTC DWG # 05-08-1110)

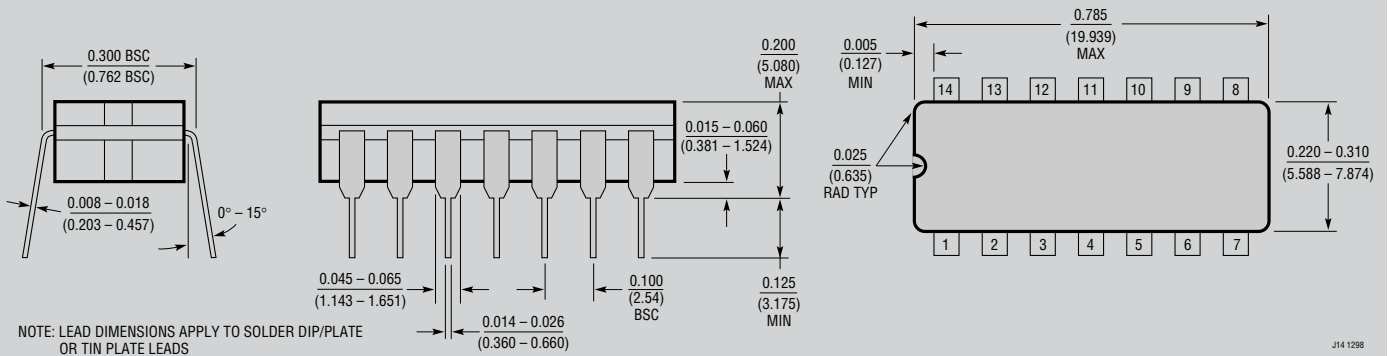

OBSOLETE PACKAGES

N8 Package 8-Lead PDIP (Narrow .300 Inch) (Reference LTC DWG # 05-08-1510)

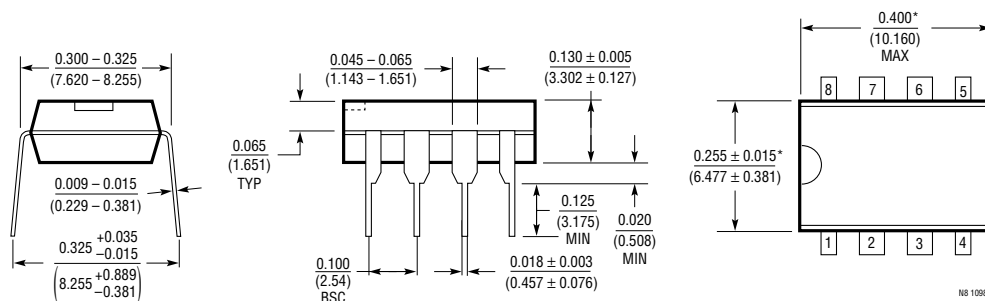

PACKAGE DESCRIPTION

N Package
14-Lead PDIP (Narrow .300 Inch)
 (Reference LTC DWG # 05-08-1510)

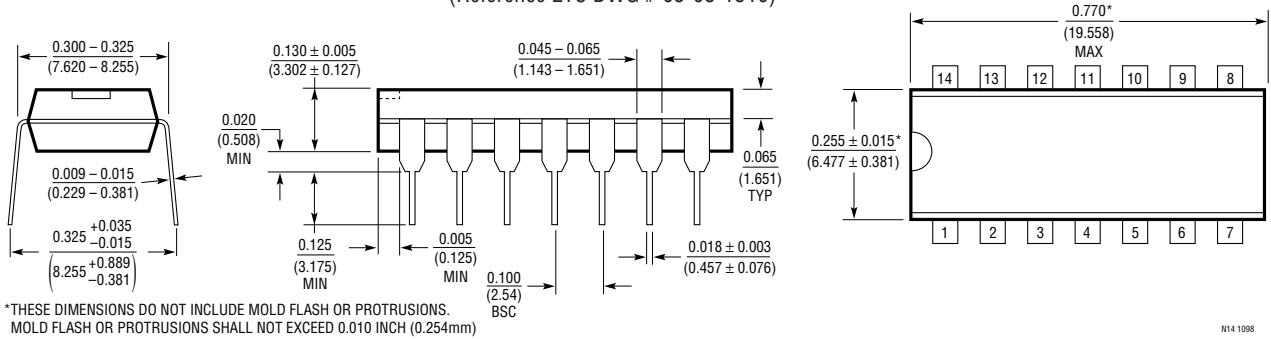

S8 Package
8-Lead Plastic Small Outline (Narrow .150 Inch)
 (Reference LTC DWG # 05-08-1610)

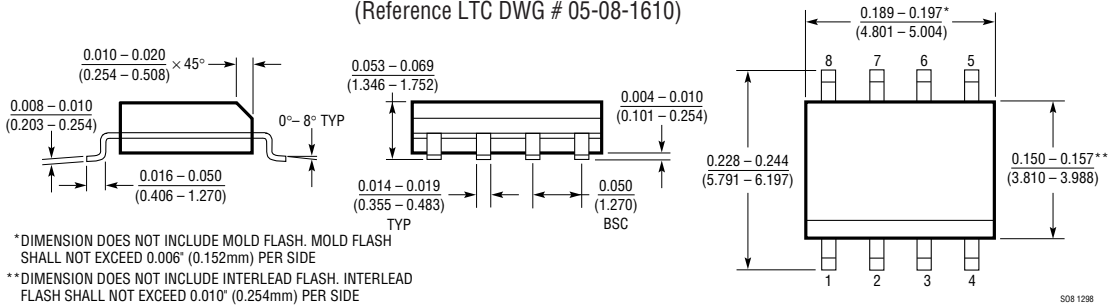

SW Package
16-Lead Plastic Small Outline (Wide .300 Inch)
 (Reference LTC DWG # 05-08-1620)

