

THESE DRAWINGS ARE THE PROPERTY OF QUALTEK ELECTRONICS AND NOT TO BE REPRODUCED FOR OR COMMUNICATED TO A THIRD PARTY WITHOUT THE EXPRESS WRITTEN PERMISSION OF AN OFFICER OF QUALTEK ELECTRONICS.

REVISION			
REV.	DESCRIPTION	DATE	APPROVED

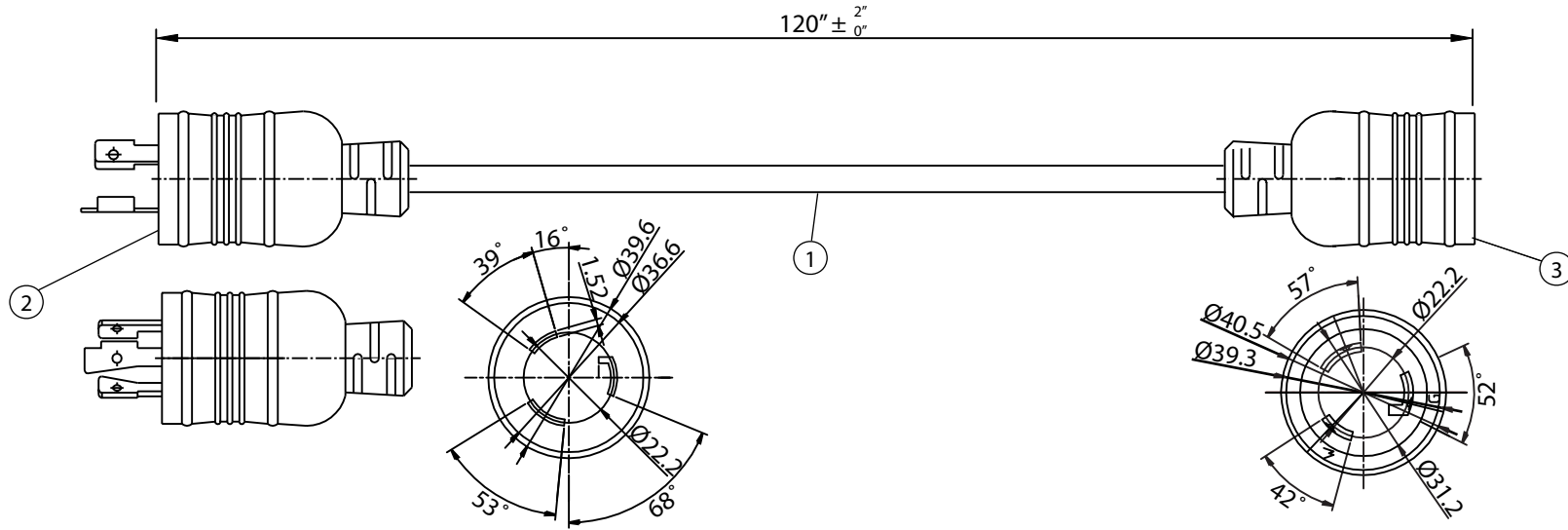

NOTES:

1. CORDAGE: SJT, 14AWG/3C, UNSHIELDED, NA COLOR CODE, TEMP. RATING 60°C, RATING: 125V 15A, JACKET COLOR: BLACK
2. PLUG: L5-20P
3. CONNECTOR: L5-20R
4. APPROVALS: UL, cUL
5. ROHS COMPLIANT

CONTROLLED

		Qualtek Electronics Corp. PPC DIVISION		
		Part Number: 250070-01		RoHS Compliant
		Description: POWER CORD		
Dim range (mm)	Tolerance +/- (mm)	UNIT: in		
0-1	0.15	Drawn / Date	Checked / Date	Approved / Date
1-6	0.20			
6-18	0.30			
18-50	0.50			
50-120	0.70	R.Nuti 10-24-07	10-24-07	JJH / 10-24-07
120-250	0.90			
250-500	1.20			