



DRH Series

- Ratings up to 18 & 20 Amps at 600 VAC
- Fits standard 35 mm DIN Rail
- Integrated over-temperature protection
- Alarm output in case of over-temperature
- Multicolor LED with input status and alarm indicator
- AC or DC control
- Zero Voltage (resistive loads) or instantaneous (inductive loads) turn-on output
- C-UL-US Listed, IEC Rated, CE & RoHS Compliant, Horsepower Rated
- Built-in Overvoltage Protection
- Fan controlled through thermistor and microprocessor to optimize fan operation

PRODUCT SELECTION

Control Voltage	18 A	20 A
90-280 VAC/VDC	DRH3P60A18	DRH3P60A20
4-32 VDC	DRH3P60D18	DRH3P60D20

AVAILABLE OPTIONS

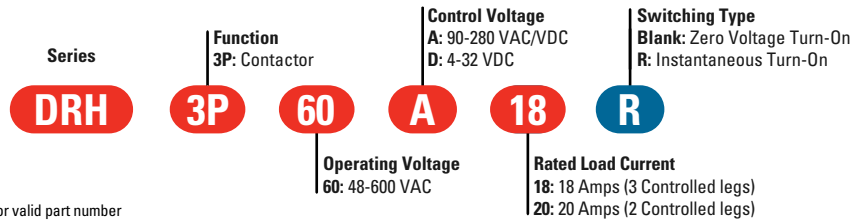

OUTPUT SPECIFICATIONS ⁽¹⁾

Description	18 A	20 A
Operating Voltage (47-63Hz) [V _{RMS}]	48-600	48-600
Transient Overvoltage [Vpk] ⁽²⁾	1200	1200
Maximum Off-State Leakage Current @ Rated Voltage [mA _{RMS}]	3	3
Minimum Off-State dV/dt @ Maximum Rated Voltage [V/μsec]	500	500
Load Current, General Use UL508/IEC62314 @ 40°C [A _{RMS}] ⁽³⁾	18	20
Load Current, Motor Starting UL508 FLA/IEC62314 @ 40°C [A _{RMS}] ⁽³⁾	7.6	7.6
Minimum Load Current [A _{RMS}]	0.15	0.15
Maximum Surge Current [A _{pk}] 1Cycle 60Hz	750	750
Maximum Surge Current [A _{pk}] 1Cycle 50Hz	716	716
Maximum I ² t for Fusing (8.33 msec) [A ² sec]	2330	2330
Maximum I ² t for Fusing (10 msec) [A ² sec]	2560	2560
Maximum On-State Voltage Drop @ Rated Current [Vpk]	1.35 per channel	1.35 per channel
Minimum Power Factor (with Maximum Load)	0.5	0.5
Motor Rating UL 508/ IEC60947-4-2 [HP/kW] :240 VAC	2/1.5	2/1.5
Motor Rating UL 508/ IEC60947-4-2 [HP/kW] :380 VAC	3/2.2	3/2.2
Motor Rating UL 508/ IEC60947-4-2 [HP/kW] :480 VAC	5/3.7	5/3.7

INPUT SPECIFICATIONS ⁽¹⁾

Description	DRH3P60Dx	DRH3P60Ax
Control Voltage Range	4-32 VDC	90-280 VAC/VDC
Minimum Turn-On Voltage	4 VDC	90 VAC/VDC
Must Turn-Off Voltage	1 VDC	10 VAC
Minimum Input Current (for on-state)	2 mA	1 mA
Maximum Input Current	17 mA	3 mA
Nominal Input Impedance [Ohms]	2k	100k
Maximum Turn-On Time [msec]	1 Cycle ⁽⁴⁾	30
Maximum Turn-Off Time [msec]	1 Cycle	40

POWER SUPPLY SPECIFICATIONS (1)

Description	DRH3P60Dx	DRH3P60Ax
Voltage Range	8-32 VDC	90-265 VAC/VDC
Minimum Turn-On Voltage	8 VDC	90 VAC/VDC
Must Turn-Off Voltage	3 VDC	5 VAC/VDC
Maximum Source Current [mA]	125	40
Maximum Start Up Time [msec]	20	50
Maximum Shut Off Time [msec]	40	500

ALARM OUTPUT (1)

Description	DRH3P60xxx
Maximum Contact Switching Voltage [Volts]	200 VDC, 120 VAC
Rated Current Resistive [A] (5)	0.5
Minimum Recommended Contact Load [mA]	10
Static Contact Resistance (max. init.) [Ohms]	0.2
Turn-On / Off Condition	See Status Chart

GENERAL SPECIFICATIONS (1)

Description	Parameters
Dielectric Strength, Input/Output/Base (50/60Hz) (6)	3750 Vrms
Minimum Insulation Resistance (@ 500 VDC)	10 ⁹ Ohm
Maximum Capacitance, Input/Output	20 pF
Ambient Operating Temperature Range (7)	-10 to 70 °C
Ambient Storage Temperature Range	-40 to 70 °C
Weight (typical)	2 Controlled Legs (7.4 oz [210 g]) / 3 Controlled Legs (8.5 oz [242 g])
Housing Material	UL94 V-0
Housing Color	Black and Light Gray
LED Status Indicator (color)	See Status Chart
Short Circuit Current Rating (8)	100kA
Pollution Degree	2
Protection Degree (9)	IP20
Humidity	85% non-condensing
Control and Auxiliary Contact Terminal Screw Torque Range (in-lb/Nm)	12 / 1.36
Load Terminal Screw Torque Range (in-lb/Nm)	15 / 1.7
Input Terminal Wire Capacity	18-12 AWG (IEC 1-4 mm ²) (stranded /solid)
Output Terminal Wire Capacity	18-10 AWG (IEC 1-6 mm ²) (stranded /solid)

THERMAL DERATE INFORMATION

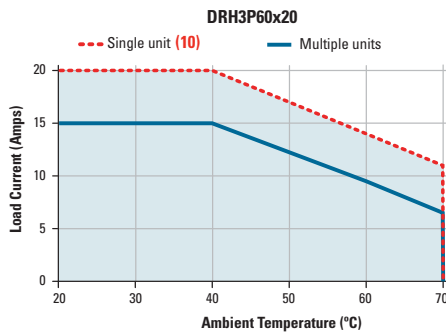
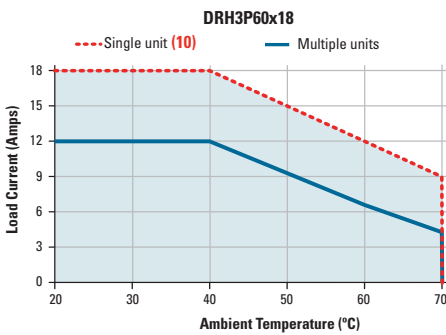

WIRING AND BLOCK DIAGRAM

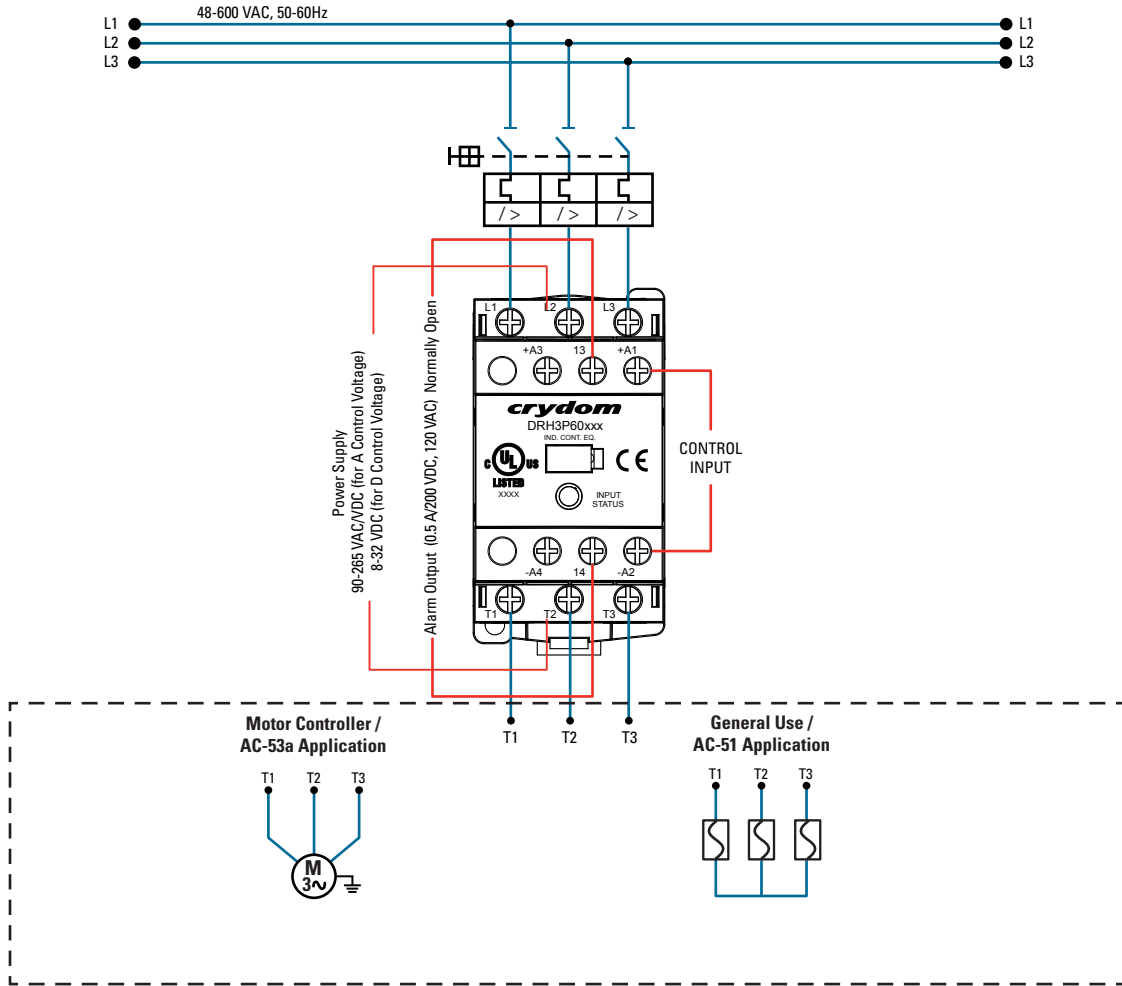

DRHP60x18
(3 controlled legs model)
Main Circuit

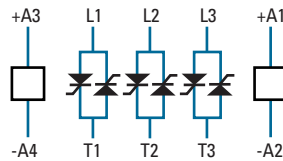

Alarm Output
(DRHP60x18 & DRHP60x20)



DRHP60x20
(2 controlled legs model)
Main Circuit

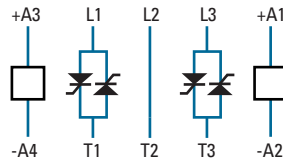

SHORT CIRCUIT AND OVERLOAD PROTECTION FOR ALL DEVICES

IEC standard 60947-4-1 make a distinction between two different types of protection, (called “coordination”), which are designated types “1” and “2”. Any short-circuit that occurs is cleared safely by either type of coordination. The only difference between the 2 categories concerns the extent of the SSR damage caused by the short-circuit.

Type “1” coordination requires that in the event of a short-circuit, the Solid State Contactor does not endanger personnel or installations, but permanent damage to the SSC is permissible. In this case the SSC may need to be replaced. For this type of co-ordination, the use of fusing or circuit breakers adequate to protect the system and wiring from short circuits, (but not specifically considering SSC protection), can be used.

Type “2” coordination requires that under a short-circuit condition, the circuit is interrupted, the SSC does not endanger persons or installations, and in addition the SSR will be able to operate after the fault condition is repaired.

Type of coordination 1

For resistive loads:

Protection by Thermal Magnetic Circuit Breaker or by Fuse (11)			
Nominal Current	Class gG fuses (example from Littlefuse)	Solid State Contactor 2 controlled legs	Solid State Contactor 3 controlled legs
0.15-20 A	CY14X51G25	DRH3P60x20	DRH3P60x18 (up to 18A)

For motor loads:

Protection by Thermal Magnetic Circuit Breaker or by Fuse (11)				
Nominal Motor Current	Thermal Magnetic Circuit Breaker (Schneider Electric)	Class gG fuses (example from Littlefuse)	Solid State Contactor 2 controlled legs	Solid State Contactor 3 controlled legs
0.40-0.63 A	GV2ME04 / GV2P04	CY14X51G16	DRH3P60x20	DRH3P60x18
0.63-1 A	GV2ME05 / GV2P05	CY14X51G16	DRH3P60x20	DRH3P60x18
1-1.6 A	GV2ME06 / GV2P06	CY14X51G25	DRH3P60x20	DRH3P60x18
1.6-2.5 A	GV2ME07 / GV2P07	CY14X51G25	DRH3P60x20	DRH3P60x18
2.5-4 A	GV2ME08 / GV2P08	CY14X51G25	DRH3P60x20	DRH3P60x18
4-6.3 A	GV2ME10 / GV2P10	CY14X51G40	DRH3P60x20	DRH3P60x18
6.3-10 A	GV2ME14 / GV2P14	CY14X51G40	DRH3P60x20 (up to 7.6A)	DRH3P60x18 (up to 7.6A)

Type of coordination 2

For resistive loads:

Protection by Fuse (11)					
Nominal Current	Semiconductor fuses with less than 2330 A ² s			Solid State Contactor 2 controlled legs	Solid State Contactor 3 controlled legs
	Littlefuse	SIBA1 (Cylindric)	Ferraz (Cylindric)		
0.15-20 A	LA50QS35-4	50 058 06.32	Z093908	DRH3P60x20	DRH3P60x18 (up to 18A)

For motor loads:

Protection by Fuse (11)					
Nominal Motor Current	Semiconductor fuses with less than 2330 A ² s			Solid State Contactor 2 controlled legs	Solid State Contactor 3 controlled legs
	Littlefuse	SIBA1 (Cylindric)	Ferraz (Cylindric)		
0.15-7.6 A	LA50QS40-4	50 058 06.40	A093909	DRH3P60x20	DRH3P60x18

STATUS CHART

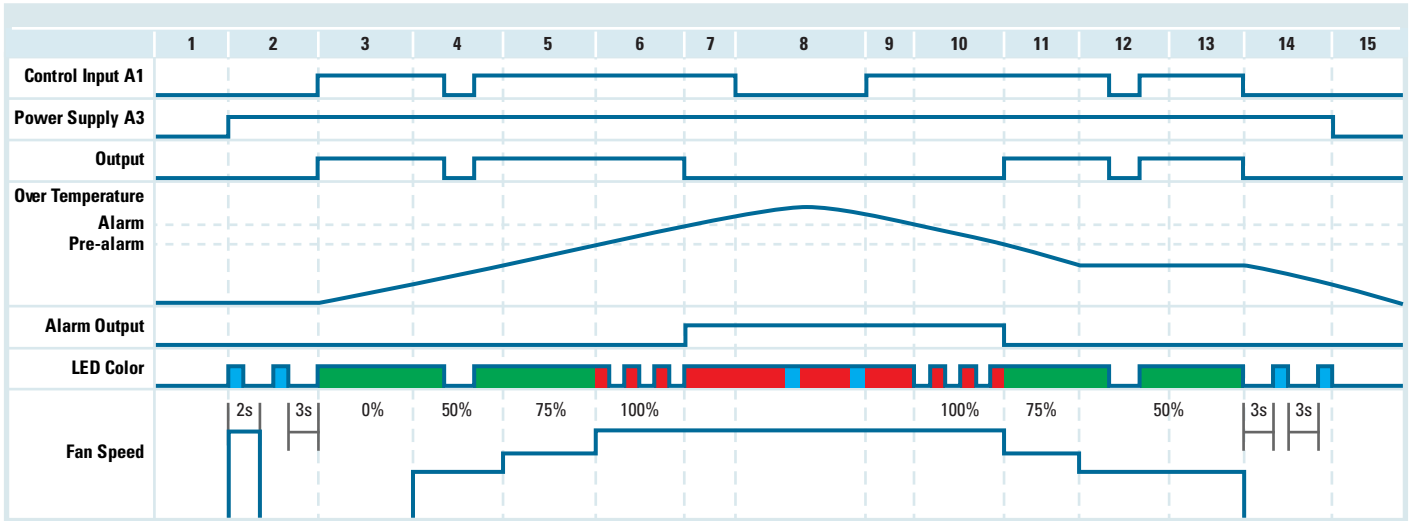

Step	Description
1, 15	Initial Condition
2, 14	Stand by condition. LED is blinking Blue. Fan is activated at full speed for 2 seconds after power is applied to A3
3	A1 is On, Output is activated, temperature rises. LED is Green
4, 12	Fan is activated at 50% speed. If A1 is disabled, LED changes to blinking Blue
5, 11	Fan is at 75% speed
6, 10	LED changes to blinking Red, fan is at full speed
7	Output is Off, Alarm Output is On, LED changes to solid Red
8	If A1 is disabled while alarm output is active, LED alternates between Blue and Red
9	LED is solid Red, temperature starts to fall
13	Fan is activated at 50% speed, temperature is steady

LED Color



MECHANICAL SPECIFICATIONS

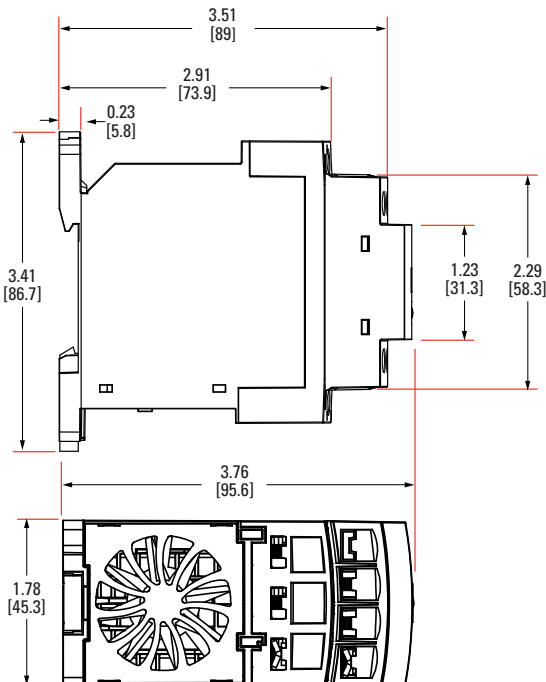

Tolerances: ±0.02 in / 0.5 mm
All dimensions are in: inches [millimeters]

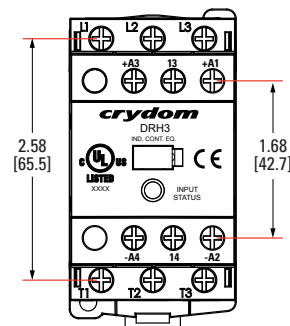

TERMINAL SCREW TYPE

Top/Bottom view (Fig. 1)

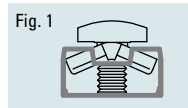

ACCESSORIES

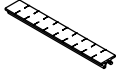
ID Marker	
	Package of 10 plastic strip comprising 10 individual markers which can be placed for easy identification during the use of multiple units.
ID Marker	
CNLB	
CNLN	
CNL2	

AGENCY APPROVALS

Certification in accordance with:

United States Standard for Industrial Control Equipment - UL 508 and Canadian Standard Association for Industrial Control Equipment – C22.2 No. 14.

DRH series conforms to the harmonized EN standard EN/IEC 60947-4-2

Electromagnetic Compatibility:
 IEC 61000-4-2 : Electrostatic Discharge – Level 3
 IEC 61000-4-4 : Electrically Fast Transients – Level 3
 IEC 61000-4-5 : Electrical Surges – Level 3

Vibration Resistance:
 IEC 60068-2-6: Amplitude Range 10-55 Hz, Displacement 0.75mm

Shock Resistance:
 IEC 60068-2-27: Peak Acceleration 15g, Duration 11msec.



GENERAL NOTES

- (1) All parameters at 25°C unless otherwise specified.
- (2) Relay will self trigger between 950-1200V, Not suitable for capacitive loads.
- (3) Mounted in the Vertical position.
- (4) Turn-on time for Instantaneous turn-on version is 4 msec.
- (5) Decrease Maximum Current 15mA/°C above 40°C ambient temperature.
- (6) For input to alarm output the dielectric strength is 1.5kV.
- (7) UL approval up to 40°C surrounding temperature.
- (8) 100kA, 480 VAC, when protected with CC class fuses rated 600VAC, 20 A or equivalent.
- (9) IP20 rating is not associated with the UL approval.
- (10) Minimum spacing to obtain max. current is 22mm between adjacent units.
- (11) Combination of these Protective Devices and Solid State Contactor have not been evaluated by UL.

⚠ DANGER / PELIGRO / DANGER /GEFAHR / PERICOLO / 危險

<p>HAZARD OF ELECTRIC SHOCK, EXPLOSION, OR ARC FLASH.</p> <ul style="list-style-type: none"> • Disconnect all power before installing or working with this equipment. • Verify all connections and replace all covers before turning on power. <p>Failure to follow these instructions will result in death or serious injury.</p>	<p>RIESGO DE DESCARGA ELECTRICA O EXPLOSION.</p> <ul style="list-style-type: none"> • Desconectar todos los suministros de energia a este equipo antes de trabajar con este equipo. • Verificar todas las conexiones y colocar todas las tapas antes de energizar el equipo. <p>El incumplimiento de estas instrucciones puede provocar la muerte o lesiones serias.</p>	<p>RISQUE DE DESCARGE ELECTRIQUE OU EXPLOSION</p> <ul style="list-style-type: none"> • Eteindre toutes les sources d'énergie de cet appareil avant de travailler dessus de cet appareil • Vérifier tous connections, et remettre tous couverts en place avant de mettre sous <p>De non-suivi de ces instructions provoquera la mort ou des lésions sérieuses.</p>	<p>GEFAHR EINES ELEKTRISCHE N SCHLAGES ODER EINER EXPLOSION.</p> <ul style="list-style-type: none"> • Stellen Sie jeglichen Strom ab, der dieses Gerät versorgt, bevor Sie an dem Gerät Arbeiten durchführen • Vor dem Drehen auf Energie alle Anschlüsse überprüfen und alle Abdeckungen ersetzen. <p>Unterlassung dieser Anweisungen können zum Tode oder zu schweren Verletzungen führen.</p>	<p>RISCHIO DI SCOSSA ELETTRICA O DELL'ESPLOSIONE.</p> <ul style="list-style-type: none"> • Spenga tutta l'alimentazione che fornisce questa apparecchiatura prima di lavorare a questa apparecchiatura • Verificare tutti i collegamenti e sostituire tutte le coperture prima dell'accensione <p>L'omissione di queste istruzioni provocherà la morte o lesioni serie</p>	<p>存在电击、爆炸或电弧闪烁危险</p> <ul style="list-style-type: none"> • 在操作此设备之前请先关闭电源。 <p>若不遵守这些说明,可能会导致严重的人身伤害甚至死亡。</p>
--	--	---	--	--	---

⚠ WARNING / AVERTISSEMENT / WARNUNG /ADVERTENCIA / AVVERTENZA / 警告

<p>RISK OF MATERIAL DAMAGE AND HOT ENCLOSURE</p> <ul style="list-style-type: none"> • The product's side panels may be hot, allow the product to cool before touching. • Follow proper mounting instructions including torque values. • Do not allow liquids or foreign objects to enter this product. <p>Failure to follow these instructions can result in serious injury, or equipment damage.</p>	<p>RISQUE DE DOMMAGE MATERIEL ET DE SURCHAUFFE DU BOITIER</p> <ul style="list-style-type: none"> • Les panneaux latéraux du produit peuvent être chauds. Laisser le produit refroidir avant de le toucher. • Respecter les consignes de montage, et notamment les couples de serrage. • Ne pas laisser pénétrer de liquide ni de corps étrangers à l'intérieur du produit. <p>Le non-respect de cette directive peut entraîner, des lésions corporelles graves ou des dommages matériels.</p>	<p>GEFAHR VON MATERIALSCHÄDEN UND GEHÄUSEERHITZUNG</p> <ul style="list-style-type: none"> • Die Seitenwände können heiß sein. Lassen Sie das Produkt abkühlen, bevor Sie es berühren. • Beachten Sie die Montageanweisungen, • Führen Sie keine Flüssigkeiten oder Fremdkörper in das Produkt ein. <p>Die Nichtbeachtung dieser Anweisung kann Körperverletzung oder Materialschäden zur Folge haben.</p>
<p>RIESGO DE DAÑOS MATERIALES Y DE SOBRECALENTAMIENTO DE LA UNIDAD</p> <ul style="list-style-type: none"> • Los paneles laterales del producto pueden estar calientes. Esperar que el producto se enfríe antes de tocarlo. • Respetar las instrucciones de montaje, y en particular los pares de apretado. • No dejar que penetren líquidos o cuerpos extraños en el producto. <p>Si no se respetan estas precauciones pueden producirse graves lesiones, daños materiales.</p>	<p>RISCHIO DI DANNI MATERIALI E D'INVOLUCRO CALDO</p> <ul style="list-style-type: none"> • I pannelli laterali dell'apparecchio possono scottare; lasciar quindi raffreddare il prodotto prima di toccarlo. • Seguire le istruzioni di montaggio corrette. • Non far entrare liquidi o oggetti estranei in questo apparecchio. <p>La mancata osservanza di questa precauzione può causare gravi rischi per l'incolumità personale o danni alle apparecchiature.</p>	<p>材料损坏和高温外壳的危险性</p> <ul style="list-style-type: none"> • 产品的一侧面板可能很热, 在其冷却前请不要触碰。 • 遵照正确的安装说明, 包括扭矩值。 • 请勿让液体及其他异物进入本产品。 <p>如不能正确执行这些操作说明, 极有可能造成严重人体伤害或者设备的损坏。</p>

ANNEX - ENVIROMENTAL INFORMATION

The environmental information disclosed in this annex including the EIP Pollution logo are in compliance with People’s Republic of China Electronic Industry Standard SJ/T11364 – 2006, Marking for Control of Pollution Caused by Electronic Information Products.

Part Name	Toxic or hazardous Substance and Elements					
	Lead (Pb)	Mercury (Hg)	Cadmium (Cd)	Hexavalent Chromium (Cr (VI))	Polybrominated biphenyls (PBB)	Polybrominated diphenyl ethers (PBDE)
Semiconductor die	X	O	O	O	O	O
Solder	X	O	O	O	O	O

附件 – 环保信息

此附件所标示的包括电子信息产品污染图标的环保信息符合中华人民共和国电子行业标准 SJ/T11364 - 2006, 电子信息产品污染控制标识要求。

部件名称	有毒有害物质或元素					
	铅 (Pb)	汞 (Hg)	镉 (Cd)	六价铬 (Cr (VI))	多溴联苯 (PBB)	多溴二苯醚 (PBDE)
半导体芯片	X	O	O	O	O	O
焊接点	X	O	O	O	O	O

